

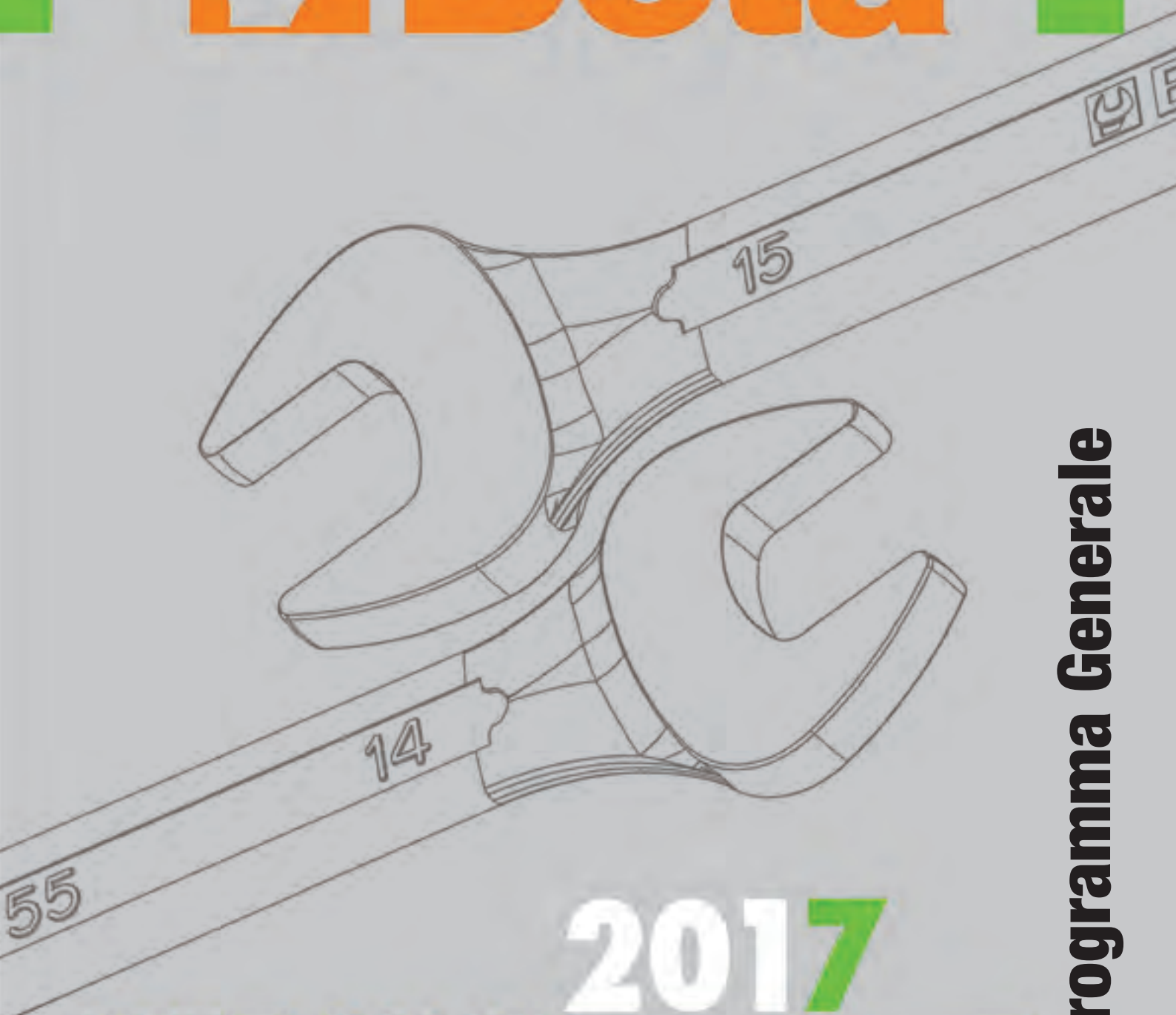

Beta



2017

WWW.BETA-TOOLS.COM

Programma Generale

1923 - Alessandro Ciceri fonda la stamperia "Alessandro Ciceri & Figli", specializzata in stampi di ferro e acciaio.

1939 - Viene depositato il marchio Beta e l'Azienda si specializza nella produzione di utensili per uso professionale.

1960 - Beta Utensili conta duecento dipendenti, esporta i propri prodotti all'estero e si afferma quale realtà emergente nel settore dell'utensileria professionale.

1969 - Nasce il rivoluzionario carrello "Tank" in lamiera arancione, il colore che, da quel momento in poi, renderà inconfondibile lo stile del marchio Beta.

1971 - Beta Utensili entra nel mondo delle competizioni motoristiche intese come momento di verifica e sviluppo dei propri prodotti.

1975 - Arriva il primo grande successo in Formula 1 con la **March-Beta Utensili** di colore arancione di Vittorio Brambilla che vince il Gran Premio d'Austria nel diluvio di Zeltweg.

1980 - Aumenta la penetrazione nei più importanti mercati Europei con la costituzione progressiva di filiali Beta Utensili in Francia, Gran Bretagna, Olanda, Spagna e Polonia.

1995 - In soli 8 mesi l'Azienda ottiene la certificazione **Sistema di Qualità ISO 9001**.

2000 - La presentazione del nuovo catalogo Beta Utensili conferma il continuo processo di crescita. Raddoppia la gamma dei prodotti in offerta e le oltre 10000 referenze vengono suddivise in 22 famiglie di prodotto.

2002 - L'offerta Beta Utensili viene ulteriormente ampliata con l'introduzione della gamma di calzature antinfortunistiche e la linea di abbigliamento da lavoro e tempo libero "Beta Work".

2009 - Beta espande ulteriormente i propri mercati aprendo due nuove filiali: Beta Cina

2012 - Apre Beta Brasile

2016 - Beta introduce un nuovo sistema modulare per l'arredo officina.

2017 - Un ininterrotto percorso di crescita che conduce alla realtà odierna: un gamma prodotto distribuita in tutto il mondo, che supera le 12.000 referenze e comprende articoli adatti a soddisfare le esigenze dei professionisti più esigenti.



1939 Reparto forgia



1950 Reparto galvanica



1955 Reparto tranciatura



1960 Magazzino spedizioni



1969 Carrello Tank



1975 Cromatura



1974 Vittorio Brambilla

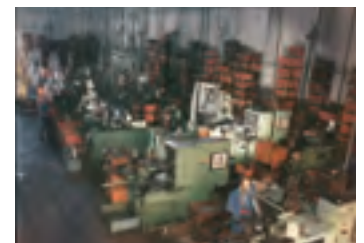

1980 Reparto meccanica



1981 Nuovi assortimenti



2016 Simone Corsi

BETA UTENSILI S.p.A. - 20845 Sovico (MB)
Via A.Volta, 18 - Tel. 039.2077.1 - Telefax 039.2010742
www.beta-tools.it

Sede produttiva Accessori per funi Robur: 67039 Sulmona (AQ)
Zona industriale - C.da S. Nicola - Tel. 0864.2504.1 - Telefax 0864.253132
www.roburitaly.com - info@roburitaly.com

1939



1950



1960



1970



1980



3 UNITÀ PRODUTTIVE

Sovico (Monza Brianza)

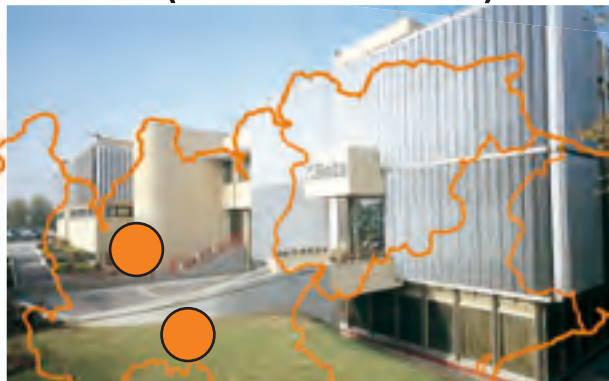

- **Oltre 500** addetti
- **100.000** metri quadri di cui **32.000** coperti
- **Oltre 10 milioni** di pezzi /anno

Castiglione d'Adda (Lodi)



Sulmona (L'Aquila)



Ergonomia, finitura e design al servizio dell'affidabilità

Per Beta, il termine design non significa solo estetica del prodotto ma soprattutto funzionalità ottimale. Lo studio e il progetto di un utensile hanno come finalità la sua sicurezza, la resistenza e la facilità d'impiego.

Per questo la progettazione di un utensile nasce dalle esigenze d'utilizzo: la funzionalità genera l'estetica e il disegno diventa la sintesi di uno studio sofisticato su materiali e finiture.

Con questi obiettivi Beta rinnova il design dei suoi prodotti, che vengono costantemente ripensati nei particolari e nei materiali.



Innovazione e qualità: le linee guida per lo sviluppo di tutti i nuovi progetti Beta.





Dal 1995 i processi produttivi sono certificati conformi agli standard del Sistema di Qualità ISO 9001

Qualità Beta, l'aspetto più concreto

In Beta la qualità assume un significato semplice e concreto: "ciò che soddisfa in modo completo le esigenze e le aspettative di quell'utenza professionale che fa del nostro prodotto uno strumento fondamentale per il proprio lavoro". L'utensile non è solo studiato e realizzato correttamente per adempiere alla sua funzione, ma garantisce la ripetitività delle prestazioni in modo omogeneo nel tempo. La qualità in Beta non si esprime solo con un'attenta politica industriale e commerciale, ma si spinge oltre, permeando ogni divisione aziendale con il medesimo orientamento per raggiungere obiettivi sempre più ambiziosi in termini di soddisfazione della clientela. È su questo concetto che Beta ha costruito la sua storia.

La qualità degli utensili Beta è la sintesi di antiche tecniche e nuove tecnologie.



Oltre 12.000 referenze

Grazie al proprio dinamismo, l'azienda è stata capace, nel corso degli anni, di aggiornare efficacemente la propria offerta per rispondere prontamente alle sfide del mercato mondiale.

Beta Utensili vanta oggi una gamma con più di 12.000 referenze suddivise in 22 famiglie di prodotto, posizionandosi tra le più qualificate realtà aziendali nel settore dell'utensileria.

Beta produce utensili per gli specialisti della meccanica, della manutenzione industriale, dell'autoriparazione ma anche per coloro per cui un hobby è molto di più che un semplice passatempo.

22

Famiglie

Ogni esigenza professionale trova una risposta efficace

Applicazioni



Automotive



Energia



Industria



Oil & Gas



Aeronautica



Un sito “facile” e completo dove è possibile trovare i cataloghi aggiornati, le ultime novità, le promozioni nonché tutte le informazioni tecniche relative ai prodotti (manuali, ricambistica e video dimostrativi, questi ultimi pubblicati anche su YouTube)



App Ipad e Android, l'applicazione specifica con tutti i cataloghi Beta.



Colonia 2016

Beta offre numerose soluzioni espositive per il punto vendita per garantire al cliente un servizio “chiavi in mano”.



www.beta-tools.it

Beta è presente
in più di
100 paesi
nel mondo

La capillarità
della rete distributiva
Beta permette
di raggiungere
agevolmente gli
utilizzatori professionali
di tutto il mondo.



Beta **Brasil**



Beta **Benelux**



Beta **China**



Beta **France**



Beta **Iberia**



Beta **Polska**



Beta **UK**



Consegne
**veloci, accurate
e complete**



12.000
i codici gestiti
con oltre **20.000**
unità di carico



15.000 m²
di superficie



RSC 55



☐ 278+292

CONTENITORI E ASSORTIMENTI



☐ 230+277



☐ 293+359

CHIAVI DI MANOVRA



☐ 16+21



☐ 26+29



☐ 90+94

CHIAVI A BUSSOLA E ACCESSORI



☐ 58+63



☐ 70+90

CHIAVI DINAMOMETRICHE E MOLTIPLICATORI



☐ 49+50



☐ 50+58

GIRAVITE, CHIAVI MASCHIO E INSERTI

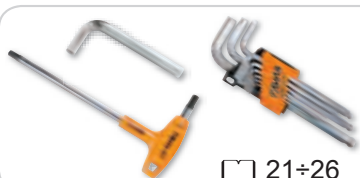

☐ 21+26



☐ 63+70



☐ 93+95



☐ 115+125

PINZE E TRONCHESI



☐ 102+107

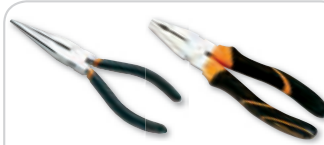

☐ 112



☐ 182

MARTELLI E SCALPELLI



☐ 15-16



☐ 127+131



☐ 169

UTENSILI PER FORARE E FILETTARE

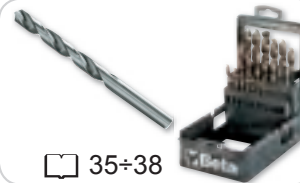

☐ 35+38



☐ 39+40



☐ 40+47



☐ 47+48

ESTRATTORI



☐ 131-132



☐ 151+158

UTENSILI PER MISURARE E TRACCIARE



☐ 163+169

UTENSILI PER TAGLIARE E MANUTENZIONI VARIE



☐ 99



☐ 107+109



☐ 124



☐ 142



☐ 159



☐ 170+179

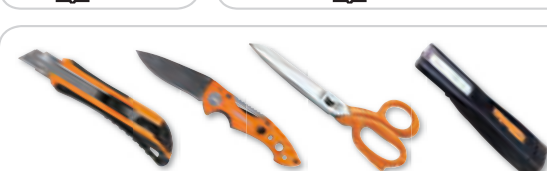

☐ 182+193



IDRAULICA



☐ 29+35

ELETTRONICA E MICROMECCANICA



☐ 101-102



☐ 113-114



☐ 117+119



☐ 185-186

ELETTROTECNICA



☐ 109+112



☐ 117



☐ 159+163



☐ 180



☐ 190

UTENSILI ISOLATI

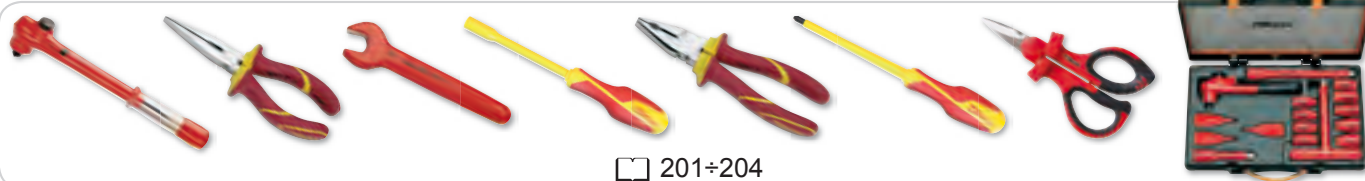

☐ 201+204

INOX



☐ 205+207



UTENSILI ANTISCINTILLA

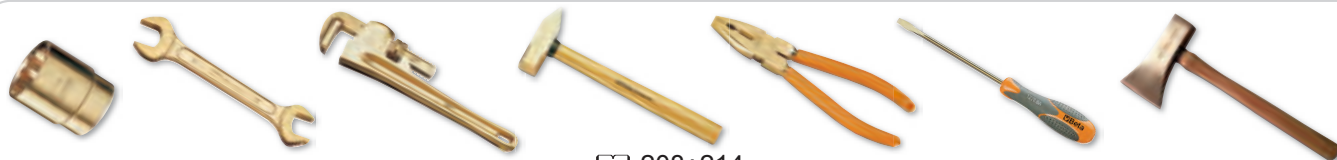

☐ 208+214

AUTORIPARAZIONE



☐ 95+101

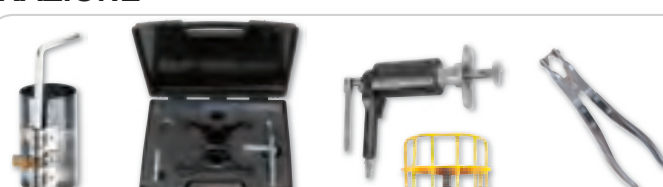

☐ 132+158



☐ 125+127



☐ 179+183



☐ 193+200

UTENSILI PNEUMATICI E ACCESSORI



ACCESSORI PER FUNI ROBUR



CALZATURE DI SICUREZZA (E CALZE TECNICHE)



ABBIGLIAMENTO DA LAVORO



SOLUZIONI PER IL PUNTO VENDITA

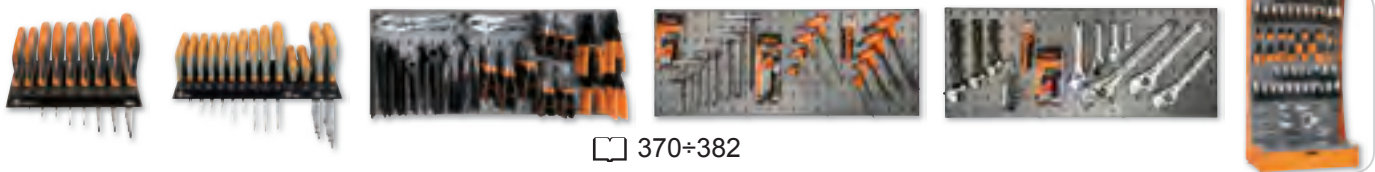

GAMMA BLISTER



BETACOLLECTION



numero articolo

94

profilo utensile



chiavi per raccordi tubi

in confezione blister



DIN 3118

- ★ articolo fornibile a richiesta
- misura principale
- ◊ bocca esagonale

novità 2017

misura

numero utensili
nella confezione

numero utensili
nella serie

tipo confezione

contenuto
della serie

mm	L	
8x10	140	2 000940008
9x11	153	2 000940009
10x11	153	2 000940010
11x13	175	2 000940011
12x14	175	2 000940012
13x15	175	2 000940013
14x15	175	2 000940014
14x17	195	2 000940015
17x19	212	2 000940017
19x22	228	2 000940019
22x24	242	2 000940022
24x27	260	2 000940024
30x32	300	2 000940030
36x41	320	1 000940036

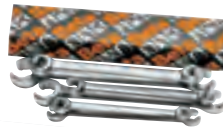

94/S6
8x10-10x11-11x13-12x14
17x19-19x22 mm

94/S10
8x10-9x11-10x11-11x13
12x14-17x19-19x22
22x24-24x27-30x32 mm

1 000940050

1 000940052

numero codice

Interpretazione delle sigle più correnti

Esempio

nelle serie	
B	= in busta di plastica 42/B9
BV	= busta vuota 42/BV9
C	= in cassetta 900/C11
D	= in confezione appendibile 1293/D6
S	= in scatola 42/S17
SP	= con supporto 42/SP17
SPV	= supporto vuoto 42/SPV1
SC	= con supporto compatto 96/SC9
SCV	= supporto compatto vuoto 96/SCV

negli assortimenti

AS	= con chiavi in pollici 5915VU/AS
E	= versione Elettronica/Elettrotecnica 5980ET/A
I	= versione Idraulica 5980ID
MT	= versione Movimento Terra 5902MT
U	= versione Universale 5915VU3
SBK	= versione Motoriparazione 5940SBK
VG	= versione Autoriparatori 5904VG/5T
VI	= versione Industria 5902VI

nelle chiavi a bussola

A	= profilo esagonale 910A
B	= profilo poligonale 910B
ES	= profilo esascalato 920ES
FTX	= per viti TORX® 910FTX

Interpretazione delle sigle più correnti

Esempio

PT	= per viti pentalobate 910PT
X	= cricchetto reversibile nelle cassette 920A/C12X

nei giravite e inserti per avvitatori

LP	= per viti con intaglio 920LP
PE	= per viti con impronta esagonale 920PE
PH	= per viti con impronta PHILLIPS® 920PH
PZ	= per viti con impronta POZIDRIV® - SUPADRIV® 1299PZ
RTX	= per viti con impronta TAMPER RESISTANT TORX® 1298RTX
SP	= per viti con impronta SPANNER 861SP
TRW	= per viti con impronta TRI-WING® 861TRW
TQS	= per viti con impronta TORQ-SET® 861TQS
TX	= per viti con impronta TORX® 920TX
XZN	= per viti con impronta XZN® 920XZN

in generale

AS	= misure in pollici 42AS
BA	= utensili antiscintilla 42BA
BM	= impugnatura bimateriale 1150BM
C	= contenitore metallico vuoto C25
INOX	= utensili acciaio inossidabile 42 INOX
L	= modello lungo 952L
MQ	= utensili isolati a 1000V 1150MQ
MP	= finitura lucida 42MP
R	= ricambio 338R

Le immagini riprodotte sono indicative.

Beta Utensili S.p.A. si riserva il diritto di apportare aggiornamenti e migliorie alla propria gamma produttiva senza preavviso.



RACCOMANDA

il corretto utilizzo degli utensili ed il rispetto delle disposizioni per la sicurezza individuale.



30

punzoni



Ø mm	L mm		
2	125	10	000300020
3	125	10	000300030
4	150	10	000300040
5	150	10	000300050
6	150	10	000300060

31

cacciaspina



Ø mm	L mm	L1 mm		
2	110	22	10	000310002
3	128	35	10	000310003
4	146	45	10	000310004
5	164	55	10	000310005
6	182	65	5	000310006
8	200	80	5	000310008
10	220	95	5	000310010



31/B6



31/SP6

31/B6	2-3-4-5-6-8 mm	1	000310020
42/BV6		1	000420051
31/SP6	2-3-4-5-6-8 mm	1	000310030
31/SPV		1	000310031

31BM

cacciaspina con impugnatura



Ø mm	L mm	L1 mm		
2	168	42	2	000310402
3	180	52	2	000310403
4	191	62	2	000310404
5	200	72	2	000310405
6	221	82	2	000310406
8	235	94	2	000310408



31BM/D6	2-3-4-5-6-8 mm	1	000310420
---------	----------------	---	-----------

31L

cacciaspina tipo lungo



Ø mm	L mm	L1 mm		
4	175	80	5	000310104
5	175	80	5	000310105
6	175	80	5	000310106

31SE

cacciaspina per spine elastiche



Ø mm	D mm	L mm	L1 mm		
4	2,4	175	80	5	000310204
5	3,0	175	80	5	000310205
6	3,6	175	80	5	000310206



31/B6-LSE	31L: 4-5-6 mm	1	000310320
31SE:	4-5-6 mm	1	000550151

32

bulini



Ø mm	L mm	L1 mm		
3	100	44	10	000320100
4	125	52	10	000320125
5	150	62	10	000320150

32AU

bulino automatico



Ø mm	L mm	L1 mm		
3	150	23	2	000320160

32AUR

punta di ricambio



Ø mm				
3			5	000320170

34

scalpelli piatti



L mm	A mm	L1 mm		
125	14,5	45	5	000340001
150	17,0	58	5	000340002
175	21,5	68	5	000340003

35

scalpelli nervati



L mm	A mm		
100	14,5	5	000350001
125	17,0	5	000350002
150	20,5	5	000350003
200	23,0	5	000350004
250	28,5	2	000350005
300	34,0	2	000350006

35PM

scalpelli nervati con paramano



L mm	A mm		
200	23,0	2	000350014
250	28,5	2	000350015
300	34,0	2	000350016

35PMR

ricambi paramano



L mm			
200		1	000350024
250		1	000350025
300		1	000350026

36

ugnetti



L mm	A mm	L1 mm		
125	4	44	5	000360001
150	6	53	5	000360002

37

ugnetti nervati



L mm	A mm	L1 mm	
150	6	45	5 000370001
200	8	55	3 000370002

37PM

ugnello nervato con paramano



L mm	A mm	
200	8	2 000370012

37PMR

ricambio paramano



L mm	
200	1 000370022



38/B6	1 000380006
30: 2-3 mm	
32: 4 mm	
34: 125-150 mm	
36: 150 mm	
42/BV6	1 000420051
38/SP6	1 000380009
30: 2-3 mm	
32: 4 mm	
34: 125-150 mm	
36: 150 mm	
38/SPV	1 000380019

42

chiavi combinate



DIN 3113 UNI-ISO 7738

mm	L mm	
5,5x5,5	95	5 000420005
6x6	95	5 000420006
7x7	105	5 000420007
8x8	116	5 000420008
9x9	127	5 000420009
10x10	137	5 000420010
11x11	148	5 000420011
12x12	158	5 000420012
13x13	169	5 000420013
14x14	180	5 000420014
15x15	190	5 000420015
16x16	201	5 000420016
17x17	212	5 000420017
18x18	222	5 000420018
19x19	233	5 000420019
20x20	243	3 000420020
21x21	254	3 000420021
22x22	264	3 000420022
23x23	275	3 000420023
24x24	285	3 000420024
25x25	296	2 000420025
26x26	307	2 000420026
27x27	317	2 000420027
28x28	328	2 000420028
29x29	338	2 000420029
30x30	349	2 000420030
32x32	370	2 000420032
34x34	391	1 000420034
35x35	412	1 000420035
36x36	412	1 000420036
38x38	433	1 000420038
41x41	465	1 000420041



42/B9	1 000420064
6-7-8-10-11-13-14-17-19 mm	
42/BV9	1 000420056



42/S14	1 000420067
6-7-8-10-11-12-13-14-15-16-17-19-22-24 mm	
42/S15	1 000420066
6-7-8-10-11-12-13-14-17-19-22-24-27-30-32 mm	
42/S17	1 000420065
6-7-8-9-10-11-12-13-14-15-16-17-18-19-20-21-22 mm	
42/S26	1 000420070
6-7-8-9-10-11-12-13-14-15-16-17-18-19-20-21-22-23-24-25-26-27-28-29-30-32 mm	

42/SC9-E

serie di 9 chiavi combinate con supporto compatto



42/SC9I	1 000420087
8-10-11-12-13-14-15-17-19 mm	
42/SCV9I	1 000420103
42/SC9E	1 000420088
8-10-11-12-13-16-17-18-19 mm	
42/SCV9E	1 000420104



42/SP25	1 000420085
6-7-8-9-10-11-12-13-14-15-16-17-18-19-20-21-22-23-24-25-26-27-28-30-32 mm	
42/SPV2	1 000420090



42/SP15	1 000420078
6-7-8-9-10-11-12-13-14-15-16-17-19-22-24 mm	
42/SPV7	1 000420097
42: 8-10-11-13-14-17-19 mm	
55: 6x7-8x9-10x11-12x13-14x15-16x17-18x19 mm	
42/SPV11	1 000420100
42MP: 8-9-10-11-12-13-14-15-16-17-19 mm	
142-142SN: 8-9-10-11-12-13-14-15-16-17-19 mm	
42/SPV15	1 000420102
42: 6-7-8-9-10-11-12-13-14-15-16-17-19-22-24 mm	

42AS

chiavi combinate



mm	L mm		
1/4x1/4	95	2	000420106
5/16x5/16	116	2	000420108
3/8x3/8	137	2	000420110
7/16x7/16	148	2	000420111
1/2x1/2	169	2	000420113
9/16x9/16	180	2	000420114
5/8x5/8	201	2	000420116
11/16x11/16	212	2	000420117
3/4x3/4	233	2	000420119
13/16x13/16	254	2	000420121
7/8x7/8	264	2	000420122
15/16x15/16	285	2	000420124
1x1	296	2	000420125
1.1/16x1.1/16	317	2	000420127
1.1/8x1.1/8	338	2	000420129
1.1/4x1.1/4	370	2	000420132
1.5/16x1.5/16	391	1	000420133
1.3/8x1.3/8	412	1	000420135
1.7/16x1.7/16	412	1	000420136
1.1/2x1.1/2	433	1	000420138



mm	L mm		
42AS/B9		1	000420155
1/4-5/16-3/8-7/16-1/2			
9/16-5/8-11/16-3/4			



mm	L mm		
42AS/13		1	000420163
1/4-5/16-3/8-7/16-1/2-9/16-5/8			
11/16-3/4-13/16-7/8-15/16-1			
42AS/16		1	000420166
1/4-5/16-3/8-7/16-1/2-9/16-5/8			
11/16-3/4-13/16-7/8-15/16-1-1.1/16-1.1/8-1.1/4			

42MP

chiavi combinate lucide



DIN 3113 UNI-ISO 7738

mm	L mm		
6x6	95	5	000420606
7x7	105	5	000420607
8x8	116	5	000420608
9x9	127	5	000420609
10x10	137	5	000420610
11x11	148	5	000420611
12x12	158	5	000420612
13x13	169	5	000420613
14x14	180	5	000420614
15x15	190	5	000420615
16x16	201	5	000420616
17x17	212	5	000420617
18x18	222	5	000420618
19x19	233	5	000420619
20x20	243	3	000420620
21x21	254	3	000420621
22x22	264	3	000420622
24x24	285	3	000420624
27x27	317	3	000420627
30x30	349	3	000420630
32x32	370	3	000420632



mm	L mm		
42MP/B9		1	000420651
6-7-8-10-11-13-14-17-19 mm			
42/BV9		1	000420056

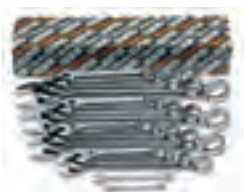

mm	L mm		
42MP/S17		1	000420652
6-7-8-9-10-11-12-13-14-15			
16-17-18-19-20-21-22 mm			
42MP/S21		1	000420653
6-7-8-9-10-11-12-13-14			
15-16-17-18-19-20-21-22			
24-27-30-32 mm			

42LMP

chiavi combinate lunghe lucide



mm	L mm		
8x8	148	2	000420508
9x9	167	2	000420509
10x10	172	2	000420510
11x11	186	2	000420511
12x12	197	2	000420512
13x13	207	2	000420513
14x14	223	2	000420514
15x15	233	2	000420515
16x16	243	2	000420516

mm	L mm		
17x17	261	2	000420517
18x18	270	2	000420518
19x19	280	2	000420519
21x21	301	2	000420521
22x22	318	2	000420522
24x24	338	2	000420524
27x27	376	2	000420527
30x30	394	2	000420530
32x32	435	2	000420532



mm	L mm		
42LMP/S14		1	000420551
8-9-10-11-12-13-14			
15-16-17-18-19-21-22 mm			
42LMP/S18		1	000420552
8-9-10-11-12-13-14			
15-16-17-18-19-21-22			
24-27-30-32 mm			

45

chiavi combinate tipo pesante



DIN 3113 UNI-ISO 7738

mm	L mm		
46x46	520	1	000450046
50x50	560	1	000450050
55x55	610	1	000450055
60x60	660	1	000450060
65x65	710	1	000450065
70x70	760	1	000450070
75x75	810	1	000450075
80x80	860	1	000450080

52

chiavi a forchetta semplici



UNI 6733 DIN 3114

mm	L mm		
10	119	5	000520010
11	119	5	000520011
12	119	5	000520012
13	145	5	000520013
14	145	5	000520014
15	145	5	000520015
16	159	5	000520016
17	159	5	000520017
18	159	5	000520018
19	175	5	000520019
20	175	5	000520020
21	175	5	000520021
22	196	2	000520022
23	196	2	000520023
24	196	2	000520024
25	215	2	000520025
26	215	2	000520026
27	215	2	000520027
28	240	2	000520028
30	240	2	000520030
32	270	2	000520032
34	270	1	000520034
35	295	1	000520035
36	295	1	000520036

Beta
INOX
STAINLESS STEEL



mm	L mm		
38	295	1	000520038
40	335	1	000520040
41	335	1	000520041
42	335	1	000520042
45	370	1	000520045
46	370	1	000520046
48	370	1	000520048
50	415	1	000520050
52	415	1	000520052
55	415	1	000520055
60	490	1	000520060
65	490	1	000520065
70	490	1	000520070

53

chiavi a forchetta DIN 894



mm	L mm		
36	317	1	000530036
38	320	1	000530038
41	342	1	000530041
46	396	1	000530046
50	412	1	000530050
55	457	1	000530055
60	492	1	000530060
65	528	1	000530065
70	572	1	000530070
75	608	1	000530075
80	645	1	000530080
85	690	1	000530085
90	690	1	000530090
95	847	1	000530095
100	847	1	000530100
105	1000	1	000530105
110	1000	1	000530110
115	1000	1	000530115
120	1000	1	000530120
125	1000	1	000530125
130	1000	1	000530130
135	1000	1	000530135

55

chiavi a forchetta doppie



UNI-ISO 10102 DIN 3110

mm	L mm		
4x5	101	5	000550003
5x5,5	101	5	000550006
5,5x7	120	5	000550009
6x7	120	5	000550012
7x8	140	5	000550018
8x9	140	5	000550021
8x10	140	5	000550024
10x11	155	5	000550030
10x12	155	5	000550033
10x13	170	5	000550035
12x13	170	5	000550042
12x14	170	5	000550045
13x14	185	5	000550047
13x17	189	5	000550051
14x15	185	5	000550054
14x17	189	5	000550057
16x17	202	5	000550060
17x19	220	2	000550063
18x19	220	2	000550066
19x22	236	2	000550069
20x22	236	2	000550075
21x23	245	2	000550078
22x24	245	2	000550081
24x26	262	2	000550087
24x27	262	2	000550090
25x28	272	2	000550096
27x29	284	2	000550099

mm	L mm		
27x30	284	2	000550102
27x32	297	2	000550105
30x32	297	2	000550108
32x36	325	1	000550114
34x36	325	1	000550117
35x38	375	1	000550120
36x41	375	1	000550123
41x46	425	1	000550129
46x50	475	1	000550132
50x55	500	1	000550135
55x60	500	1	000550138



55/B8	6x7-8x9-10x11-12x13 14x15-16x17-18x19 20x22 mm	1	000550158
55/BV8		1	000550159
55/B12	6x7-8x9-10x11-12x13 14x15-16x17-18x19 20x22-21x23-24x26 25x28-30x32 mm	1	000550162
55/BV12		1	000550163



55/S8	6x7-8x9-10x11-12x13 14x15-16x17-18x19 20x22 mm	1	000550174
55/S12	6x7-8x9-10x11-12x13 14x15-16x17-18x19 20x22-21x23-24x26 25x28-30x32 mm	1	000550178
55/S12X	6x7-8x9-10x11-12x13 14x15-16x17-18x19 20x22-21x23-24x27 25x28-30x32 mm	1	000550179
55/S13	6x7-8x9-10x11-12x13 14x15-16x17-18x19 20x22-21x23-24x26 25x28-27x29-30x32 mm	1	000550182



55/SP7



55/SP13

55/SP7	6x7-8x9-10x11-12x13 14x15-16x17-18x19 mm	1	000550167
42/SPV7	42: 8-10-11-13-14-17-19 mm	1	000420097
55:	6x7-8x9-10x11-12x13 14x15-16x17-18x19 mm		
55/SP13	6x7-8x9-10x11-12x13 14x15-16x17-18x19 20x22-21x23-24x26 25x28-27x29-30x32 mm	1	000550186
55/SPV		1	000550190

55AS

chiavi a forchetta doppie



mm	L mm		
1/4x9/32	120	2	000550203
1/4x5/16	120	2	000550206
5/16x11/32	140	2	000550209
5/16x3/8	140	2	000550212
3/8x7/16	155	2	000550215
7/16x1/2	170	2	000550218
1/2x9/16	170	2	000550221
9/16x5/8	185	2	000550224
19/32x11/16	189	2	000550227
5/8x11/16	202	2	000550230
5/8x3/4	202	2	000550233
11/16x13/16	220	2	000550242
3/4x7/8	236	2	000550245
25/32x13/16	236	2	000550244
7/8x15/16	245	2	000550251
15/16x1	262	1	000550257
1x1.1/8	272	1	000550259
1.1/16x1.1/4	284	1	000550267
1.1/8x1.5/16	297	1	000550266
1.5/16x1.1/2	325	1	000550269
1.3/8x1.1/2	375	1	000550272
1.7/16x1.5/8	375	1	000550275



55AS/5	5/16x11/32-3/8x7/16 1/2x9/16-5/8x11/16 3/4x7/8	1	000550290
55AS/7	5/16x11/32-3/8x7/16 1/2x9/16-5/8x3/4 11/16x13/16 7/8x15/16-1.1/8x1.5/16	1	000550295
55AS/11	1/4x9/32-5/16x11/32 3/8x7/16-1/2x9/16 19/32x11/16-5/8x3/4 25/32x13/16-7/8x15/16 1x1.1/8-1.1/16x1.1/4 1.1/8x1.5/16	1	000550300

55MP

chiavi a forchetta doppie lucide



UNI-ISO 10102 DIN 3110

mm	L mm		
6x7	120	2	000550603
8x9	140	2	000550606
10x11	155	2	000550609
12x13	170	2	000550612
14x15	185	2	000550615
16x17	202	2	000550618
18x19	220	2	000550621
20x22	236	2	000550624
21x23	245	2	000550627
24x26	262	1	000550630
25x28	272	1	000550633
27x29	284	1	000550636
30x32	297	1	000550639



55MP/S8	1	000550650
6x7-8x9-10x11-12x13		
14x15-16x17-18x19		
20x22 mm		
55MP/S13	1	000550651
6x7-8x9-10x11-12x13		
14x15-16x17-18x19		
20x22-21x23-24x26		
25x28-27x29-30x32 mm		

58

chiavi a forchetta a percussione



DIN 133

mm	L mm		
24	177	1	000580024
27	180	1	000580027
30	190	1	000580030
32	190	1	000580032
34	200	1	000580034
36	215	1	000580036
41	235	1	000580041
46	255	1	000580046
50	275	1	000580050
55	300	1	000580055
60	320	1	000580060
65	342	1	000580065
70	375	1	000580070
75	375	1	000580075
80	408	1	000580080
85	408	1	000580085
90	445	1	000580090
95	445	1	000580095
100	485	1	000580100
105	485	1	000580105
110	510	1	000580110
115	510	1	000580115
120	545	1	000580120
125	545	1	000580125
130	575	1	000580130

mm	L mm		
135	575	1	000580135
★140	575	1	000580140
★145	640	1	000580145
★150	640	1	000580150
★155	640	1	000580155
★160	640	1	000580160
★165	715	1	000580165
★170	715	1	000580170
★175	715	1	000580175
★180	715	1	000580180
★185	715	1	000580185
★190	800	1	000580190
★195	800	1	000580195
★200	800	1	000580200
★210	800	1	000580210
★220	800	1	000580220
★230	800	1	000580230

73

chiavi a forchetta doppie piccole



UNI 6737

mm	L mm		
4x4	78	5	000730040
4,5x4,5	78	5	000730045
5x5	78	5	000730050
5,5x5,5	86	5	000730055
6x6	86	5	000730060
7x7	86	5	000730070
8x8	97	5	000730080
9x9	97	5	000730090
10x10	108	5	000730100
11x11	108	5	000730110
12x12	124	5	000730120
13x13	124	5	000730130
14x14	124	5	000730140



73/B13	1	000730200
4-4,5-5-5,5-6-7-8-9		
10-11-12-13-14 mm		
73/BV	1	000730201



73/S13	1	000730210
4-4,5-5-5,5-6-7-8-9		
10-11-12-13-14 mm		

Beta

78

chiavi poligonali a percussione



DIN 7444

mm	L mm		
24	162	1	000780024
27	180	1	000780027
30	190	1	000780030
32	190	1	000780032
36	205	1	000780036
41	225	1	000780041
46	235	1	000780046
50	250	1	000780050
55	265	1	000780055
60	275	1	000780060
65	295	1	000780065
70	325	1	000780070
75	325	1	000780075
80	350	1	000780080
85	350	1	000780085
90	390	1	000780090
95	390	1	000780095
100	420	1	000780100
105	420	1	000780105
110	450	1	000780110
115	450	1	000780115
120	490	1	000780120
125	480	1	000780125
130	520	1	000780130
135	520	1	000780135
★140	520	1	000780140
★145	580	1	000780145
★150	580	1	000780150
★155	580	1	000780155
★160	650	1	000780160
★165	650	1	000780165
★170	650	1	000780170
★175	650	1	000780175
★180	650	1	000780180
★185	695	1	000780185
★190	695	1	000780190
★195	695	1	000780195
★200	695	1	000780200
★210	740	1	000780210
★215	740	1	000780215
★220	740	1	000780220
★230	740	1	000780230

78AS

chiavi poligonali a percussione



mm	L mm		
★1.1/16	180	1	000780327
★1.1/8	190	1	000780329
★1.3/16	190	1	000780330
★1.1/4	197	1	000780332
★1.5/16	197	1	000780333
★1.3/8	223	1	000780335
★1.7/16	223	1	000780336
★1.1/2	223	1	000780338
★1.5/8	223	1	000780341
★1.11/16	225	1	000780343
★1.13/16	240	1	000780346
★1.7/8	250	1	000780348
★2	250	1	000780350
★2.1/16	250	1	000780352
★2.3/16	275	1	000780355
★2.3/8	270	1	000780360
★2.9/16	302	1	000780365
★2.3/4	350	1	000780370
★2.15/16	350	1	000780375
★3.1/8	354	1	000780380

80

chiavi a bussola poligonale
snodate doppie



mm	L mm		
6x7	170	3	000800006
8x9	176	3	000800008
8x10	179	3	000800009
10x11	182	3	000800010
12x13	228	3	000800012
14x15	232	3	000800014
13x17	231	3	000800015
16x17	234	2	000800016
18x19	285	2	000800018
19x22	287	2	000800019
20x22	289	2	000800020
21x23	289	2	000800021
24x27	405	2	000800024
30x32	413	2	000800030

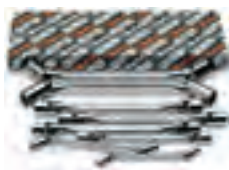

80/S8 1 000800051

6x7-8x9-10x11-12x13-14x15
16x17-18x19-20x22 mm

80/S11 1 000800056

6x7-8x9-10x11-12x13
14x15-16x17-18x19-20x22
21x23-24x27-30x32 mm

83

chiavi poligonali per starter



ISO 3318

mm	L mm		
8x10	126	3	000830008
10x12	137	3	000830010
11x13	138	3	000830011
14x17	183	3	000830014
15x17	184	2	000830015
16x18	196	2	000830016
19x22	231	2	000830019



83/S3 1 000830081

11x13-14x17-19x22 mm

83/S5 1 000830085

10x12-11x13-15x17
16x18-19x22 mm

83AS

chiavi poligonali per starter



mm	L mm		
7/16x1/2	138	2	000830111
9/16x5/8	183	2	000830114
3/4x7/8	230	2	000830119



83AS/3 1 000830181

7/16x1/2-9/16x5/8
3/4x7/8

90

chiavi poligonali doppie curve



DIN 838 ISO 10104

mm	L mm		
6x7	165	5	000900006
8x9	180	5	000900012
8x10	180	5	000900015
10x11	195	5	000900018
10x12	195	5	000900021
11x13	215	5	000900024
12x13	215	5	000900027
12x14	215	5	000900030
14x15	230	5	000900033
14x17	250	5	000900036
16x17	250	5	000900039
17x19	265	5	000900042
18x19	265	5	000900045
19x22	285	3	000900048
20x22	285	3	000900051
21x23	305	2	000900057
22x24	305	2	000900060
24x26	325	2	000900063
24x27	325	2	000900067
25x28	340	2	000900070
27x29	355	2	000900073
27x30	355	2	000900076
27x32	375	2	000900078
30x32	375	2	000900080
32x36	395	1	000900088
34x36	415	1	000900089
35x38	415	1	000900091
36x41	435	1	000900094
41x46	460	1	000900097
46x50	500	1	000900100



90/B8 1 000900154

6x7-8x9-10x11-12x13
14x15-16x17-18x19
20x22 mm

90/BV8 1 000900155

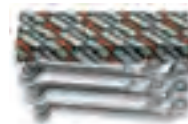

90/S8 1 000900162

6x7-8x9-10x11-12x13
14x15-16x17-18x19
20x22 mm

90/S12 1 000900166

6x7-8x9-10x11-12x13
14x15-16x17-18x19
20x22-21x23-24x26
25x28-30x32 mm

90/S12X 1 000900167

6x7-8x9-10x11-12x13
14x15-16x17-18x19
20x22-21x23-24x27
25x28-30x32 mm

90/S13 1 000900170

6x7-8x9-10x11-12x13
14x15-16x17-18x19
20x22-21x23-24x26
25x28-27x29-30x32 mm



90/SP13 1 000900174

6x7-8x9-10x11-12x13
14x15-16x17-18x19
20x22-21x23-24x26
25x28-27x29-30x32 mm

55/SPV 1 000550190

90AS

chiavi poligonali doppie curve



mm	L mm		
1/4x5/16	165	2	000900203
5/16x11/32	180	2	000900206
5/16x3/8	180	2	000900209
3/8x7/16	195	2	000900212
7/16x1/2	215	2	000900215
1/2x9/16	230	2	000900218
9/16x5/8	230	2	000900221
19/32x11/16	250	2	000900222
5/8x11/16	250	2	000900224
5/8x3/4	265	2	000900227
11/16x3/4	265	1	000900230
11/16x13/16	265	1	000900233
3/4x25/32	265	1	000900235
3/4x7/8	285	1	000900237
13/16x7/8	285	1	000900240
7/8x15/16	305	1	000900243
15/16x1	325	1	000900252
1.1/16x1.1/4	375	1	000900258
1.1/8x1.5/16	375	1	000900261

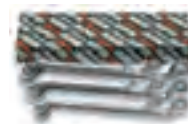

90AS/8 1 000900298

1/4x5/16-5/16x11/32
3/8x7/16-1/2x9/16
5/8x11/16-11/16x3/4
13/16x7/8-15/16x1

90AS/10 1 000900300

1/4x5/16-5/16x11/32
3/8x7/16-1/2x9/16
5/8x11/16-11/16x3/4
13/16x7/8-15/16x1
1.1/16x1.1/4-1.1/8x1.5/16

91

chiavi poligonali curve



mm	Ø		
24	38	1	000910024
27	41	1	000910027
30	48	1	000910030
32	49	1	000910032
36	54	1	000910036
41	62	1	000910041
46	69	1	000910046
50	76	1	000910050
55	81	1	000910055
60	90	1	000910060
65	98	1	000910065
70	105	1	000910070
75	110	1	000910075
80	125	1	000910080
85	125	1	000910085
90	140	1	000910090
95	140	1	000910095
100	143	1	000910100
105	146	1	000910105

92

leve di manovra per art. 91



	L	91	Ø		
	mm	mm	mm		
92/1	460	24÷30	19	1	000920010
92/2	610	32÷41	22	1	000920020
92/3	760	46÷55	25	1	000920030
92/4	860	60÷105	30	1	000920040

93

chiave per ponteggi



mm	L		
mm	mm		
21x22	310	3	000930021

93C

chiavi a cricchetto per ponteggi



mm	L		
mm	mm		
17x19	315	1	000930117
19x22	315	1	000930119
19x24	315	1	000930120
21x22	315	1	000930121

94

chiavi per raccordi tubi



DIN 3118

mm	L		
mm	mm		
8x10	140	2	000940008
9x11	153	2	000940009
10x11	153	2	000940010
11x13	175	2	000940011
12x14	175	2	000940012
13x15	175	2	000940013
14x15	175	2	000940014
14x17	195	2	000940015
17x19	212	2	000940017
19x22	228	2	000940019
22x24	242	2	000940022
24x27	260	2	000940024
30x32	300	2	000940030
36x41	320	1	000940036



94/S6

8x10-10x11-11x13-12x14
17x19-19x22 mm

1 000940050

94/S10

8x10-9x11-10x11-11x13
12x14-17x19-19x22
22x24-24x27-30x32 mm

1 000940052

95

chiavi poligonali doppie diritte



DIN 837 ISO 10103

mm	L		
mm	mm		
6x7	120	3	000950161
8x9	135	3	000950162
10x11	150	3	000950163
12x13	165	3	000950164
14x15	185	3	000950165
16x17	210	3	000950166
17x19	225	3	000950167
18x19	225	2	000950168
20x22	240	2	000950169
21x23	255	2	000950170
24x26	270	2	000950171
25x28	285	2	000950172
27x29	315	2	000950173
30x32	335	2	000950174



95/S8

6x7-8x9-10x11-12x13
14x15-16x17-18x19
20x22 mm

1 000950177

95/S13

6x7-8x9-10x11-12x13
14x15-16x17-18x19
20x22-21x23-24x26
25x28-27x29-30x32 mm

1 000950179

95FTX

chiavi doppie dirtte per viti con teste a profilo Torx®



	L		
	mm		
E6xE8	115	2	000950306
E10xE12	143	2	000950310
E14xE18	177	2	000950314
E20xE24	224	2	000950320



95FTX/S4

E6xE8-E10xE12
E14xE18-E20xE24

1 000950325

96

chiavi maschio esagonale piegate cromate



ISO 2936

mm	L	L1		
mm	mm	mm		
0,9	35	8	20	000960013
1,3	39	10	20	000960014
1,5	45	15	20	000960015
2	50	17	20	000960020
2,5	57	20	20	000960025
3	64	22	20	000960030
3,5	68	25	20	000960035
4	72	28	20	000960040
4,5	78	30	20	000960045
5	83	32	20	000960050
6	94	37	20	000960060
7	99	40	10	000960070
8	105	43	10	000960080
9	111	46	10	000960090
10	119	49	10	000960100
11	126	52	10	000960110
12	134	56	10	000960120
13	142	62	10	000960130
14	151	69	10	000960140
16	165	75	5	000960160
17	174	79	5	000960170
19	196	88	5	000960190
22	216	100	3	000960220
24	242	112	1	000960240
27	271	125	1	000960270
30	309	140	1	000960300
32	341	155	1	000960312
36	385	174	1	000960316



96/ST6

2,5-3-4-5-6-8 mm

3 000960370



96/BGS7
1,5-2-2,5-3-4-5-6 mm

1 000960367



96/BG7
2,5-3-4-5-6-8-10 mm

1 000960368



96/B8
2-2,5-3-4-5-6-8-10 mm

5 000960386

96/B10
1,5-2-2,5-3-4-5-6-8-10-12 mm

5 000960380

96N/BV 1 000960651



96/SC9
1,5-2-2,5-3-4-5-6-8-10 mm

1 000960374

96/SCV 1 000960985



96/SC12
2-2,5-3-3,5-4-4,5-5-6-7-8-9-10 mm

1 000960395

96/SCV12 1 000960975

96N

chiavi maschio esagonale piegate
brunite



ISO 2936

mm	L mm	L1 mm		
0,9	32	10	20	000960409
1,3	44	12	20	000960413
1,5	46	15	20	000960415
2	51	17	20	000960420
2,5	57	20	20	000960425
3	64	22	20	000960430
3,5	68	25	20	000960435
4	72	28	20	000960440
4,5	78	30	20	000960445
5	83	32	20	000960450
6	94	37	20	000960460
7	99	40	10	000960470
8	105	43	10	000960480
9	111	46	10	000960490
10	119	49	10	000960500
11	126	52	10	000960510
12	134	56	10	000960520
13	142	62	10	000960530
14	151	69	10	000960540
16	165	72	5	000960560
17	174	79	5	000960570
19	194	88	5	000960590



96N/ST6
2,5-3-4-5-6-8 mm

3 000960640



96N/G7
2,5-3-4-5-6-8-10 mm

3 000960645

96N/G7A
1,5-2-2,5-3-4-5-6 mm

3 000960643



96N/B10
1,5-2-2,5-3-4-5-6-8-10-12 mm

5 000960650

96N/BV 1 000960651



96N/SC9
1,5-2-2,5-3-4-5-6-8-10 mm

1 000960644

96N/SCV 1 000960986



96N/SC12
2-2,5-3-3,5-4-4,5-5-6-7-8-9-10 mm

1 000960661

96N/SCV12 1 000960976

96C/AS

chiavi maschio esagonale piegate
cromate



"	L mm	L1 mm	g		
1/16	46	16	1,01	20	000961702
3/32	53	19	2,70	20	000961706
1/8	60	22	5,33	20	000961710
5/32	67	25	9,33	20	000961714
3/16	74	28	14,87	20	000961716
7/32	81	32	22,00	20	000961718
1/4	89	35	31,40	20	000961720
5/16	103	40	56,16	10	000961724
3/8	117	45	91,31	10	000961728



96C-AS/SC9
1/16-3/32-1/8-5/32-3/16-7/32-1/4-5/16-3/8

1 000961753

Beta

Beta

96AS

chiavi maschio esagonale piegate
brunite



"	L mm	L1 mm		
1/30 (0,035")	44	14	20	000960698
1/20 (0,050")	44	15	20	000960701
1/16	46	16	20	000960702
5/64	50	18	20	000960704
3/32	53	19	20	000960706
7/64	57	21	20	000960708
1/8	60	22	20	000960710
9/64	64	24	20	000960712
5/32	68	25	20	000960714
3/16	75	29	20	000960716
7/32	82	32	20	000960718
1/4	89	35	20	000960720
5/16	103	40	10	000960724
3/8	117	44	10	000960728
7/16	132	49	10	000960730
1/2	149	54	10	000960732



96AS/SC9 1/16-3/32-1/8-5/32-3/16 7/32-1/4-5/16-3/8	1	000960743
96AS/SCV	1	000960744



96AS/T7 3/32-1/8-5/32 3/16-7/32-1/4-5/16	3	000960740
---	---	-----------



96AS/G7 3/32-1/8-5/32 3/16-1/4-5/16-3/8	3	000960745
--	---	-----------



96AS/BG7 3/32-1/8-5/32-3/16 1/4-5/16-3/8	1	000960747
---	---	-----------



96AS/B11 1/20-1/16-5/64-3/32 1/8-5/32-3/16-7/32 1/4-5/16-3/8	1	000960749
96N/BV	1	000960651

96LC

chiavi maschio esagonale piegate
tipo lungo, cromate



ISO 2936

mm	L mm	L1 mm		
2	101	17	20	000960320
2,5	113	20	20	000960321
3	127	22	20	000960322
3,5	138	25	20	000960323
4	142	28	20	000960324
4,5	154	28	20	000960325
5	163	32	20	000960326
6	184	37	20	000960327
7	194	40	10	000960328
8	205	43	10	000960329
9	216	46	10	000960330
10	231	49	10	000960331
12	259	56	10	000960332



96LC/SC8 2-2,5-3-3,5-4-4,5-5 96LC/SCV	1	000960334
	1	000960983



96LC/SC12 2-2,5-3-3,5-4-4,5-5 6-7-8-9-10 mm 96LC/SCV12	1	000960337
	1	000960977



96L

chiavi maschio esagonale piegate
tipo lungo, brunite



ISO 2936

mm	L mm	L1 mm		
2	99	15	20	000960820
2,5	110	17	20	000960825
3	124	19	20	000960830
3,5	135	21	20	000960835
4	138	24	20	000960840
4,5	150	25	20	000960845
5	158	27	20	000960850
6	178	31	20	000960860
7	187	33	10	000960870
8	197	35	10	000960880
9	207	37	10	000960890
10	221	39	10	000960900
12	247	44	10	000960920



96L/SC8 2-2,5-3-3,5-4-5-6-8-10 mm 96L/SCV	1	000960924
	1	000960987



96L/SC12 2-2,5-3-3,5-4-4,5-5 6-7-8-9-10 mm 96L/SCV12	1	000960929
	1	000960978

96BPC

chiavi maschio esagonale piegate
con estremità sferica, cromate



mm	L mm	L1 mm		
1,5	79	13	10	000960340
2	84	15	10	000960341
2,5	89	17	10	000960342
3	99	19	10	000960343
4	108	24	10	000960344
5	126	27	10	000960345
6	148	31	10	000960346
7	157	33	5	000960353
8	168	35	5	000960347
10	187	39	5	000960348



96BPC/SC9
1,5-2-2,5-3-4-5-6-8-10 mm
96BPC/SCV 1 000960354
1 000960984

96BP

chiavi maschio esagonale
piegate con estremità sferica, brunite

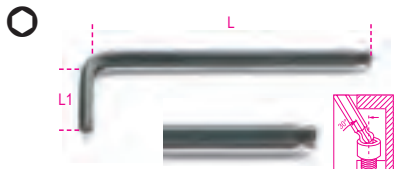

mm	L mm	L1 mm		
1,5	79	13	10	000960960
2	84	15	10	000960961
2,5	89	17	10	000960962
3	99	19	10	000960963
4	108	24	10	000960965
5	126	27	10	000960967
6	148	31	10	000960968
8	168	35	5	000960970
10	187	39	5	000960972



96BP/SC9
1,5-2-2,5-3-4-5-6-8-10 mm
96BP/SCV 1 000960974
1 000960988

96LBP

chiavi maschio esagonale
piegate con estremità sferica,
modello extralungo, cromate



mm	L mm	L1 mm		
1,5	90	15	5	000961340
2	100	17	5	000961341
2,5	112	20	5	000961342
3	127	22	5	000961343
4	144	27	5	000961344
5	163	32	5	000961345
6	184	37	5	000961346
8	204	44	2	000961348
10	230	49	2	000961350



96LBP/SC9
1,5-2-2,5-3-4-5-6-8-10 mm
96LBP/SCV 1 000961354
1 000961984

Beta

96BP/AS

chiavi maschio esagonale
piegate con estremità sferica, brunite

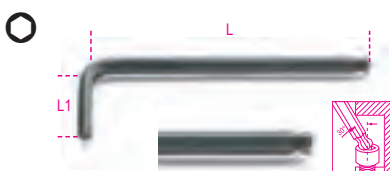

"	L mm	L1 mm		
3/32	89	17	10	000960989
1/8	98	18	10	000960990
5/32	108	24	10	000960991
3/16	126	26	10	000960992
7/32	139	28	10	000960993
1/4	152	31	10	000960994
5/16	168	34	5	000960995
3/8	190	39	5	000960996



96BP/AS-SC9
1/16-3/32-1/8-5/32-3/16
7/32-1/4-5/16-3/8
96 BP/AS-SCV 1 000961000
1 000961001



96BP/AS8
3/32-1/8-5/32-3/16-7/32
1/4-5/16-3/8
96BP/ASBV 1 000960997
1 000960998

Beta

INOX

STAINLESS STEEL



96BPA

chiavi maschio esagonale
piegate a 110° con estremità sferica,
modello lato extra corto, cromate



mm	L mm	L1 mm		
1,5	71	9	5	000961960
2	86	11	5	000961961
2,5	96	13	5	000961962
3	104	15	5	000961963
4	116	17	5	000961964
5	132	19	5	000961965
6	155	21	5	000961966
8	176	24	2	000961968
10	200	27	2	000961970



96BPA/SC9
1,5-2-2,5-3-4-5-6-8-10 mm
96BPA/SCV 1 000961974
1 000961988

96T

chiavi maschio esagonale piegate
con impugnatura di manovra

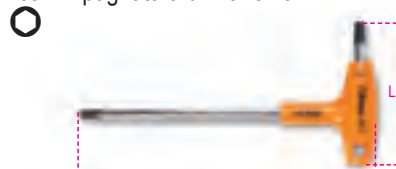

mm	L mm	L1 mm		
2	139	52	5	000960934
2,5	153	55	5	000960935
3	153	55	5	000960936
3,5	179	70	5	000960937
4	179	70	5	000960938
4,5	200	84	5	000960939
5	200	84	5	000960940
6	221	103	5	000960941
7	236	106	3	000960942
8	255	117	3	000960943
10	285	132	3	000960945



96T/S6
2-2,5-3-4-5-6 mm
96T/S11
2-2,5-3-3,5-4-4,5-5-6-7-8-10 mm
1 000960952
1 000960951



96T/SP11
2-2,5-3-3,5-4-4,5-5
6-7-8-10 mm

1 000960957

96T/SPV 1 000960958

96T/AS

chiavi maschio esagonale piegate
con impugnatura di manovra

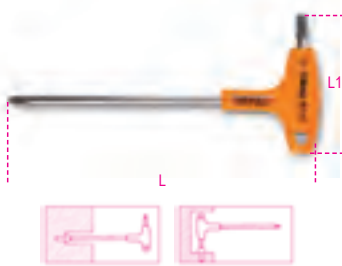

"	L mm	L1 mm	
3/32	153	55	2 000960669
7/64	153	55	2 000960670
1/8	179	70	2 000960671
9/64	179	70	2 000960672
5/32	200	84	2 000960673
3/16	200	84	2 000960674
7/32	221	103	2 000960675
1/4	236	106	2 000960676
5/16	255	117	2 000960678
3/8	285	132	2 000960680

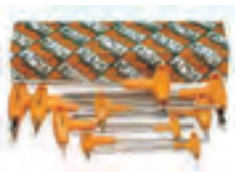

96TAS/10
3/32-7/64-1/8-9/64-5/32
3/16-7/32-1/4-5/16-3/8

1 000960683

Beta

Beta
INOX
STAINLESS STEEL



96TBP

chiavi maschio esagonale piegate
con estremità sferica ed impugnatura
di manovra



mm	L mm	L1 mm	
2,5	153	55	3 000960685
3	153	55	3 000960686
4	179	70	3 000960687
5	200	84	3 000960688
6	221	103	3 000960689
8	255	117	2 000960690



96TBP/S6
2,5-3-4-5-6-8 mm 1 000960694

97TX

chiavi maschio piegate
per viti con impronta Torx®



	L mm	L1 mm	
T6	42	16	5 000970006
T7	48	16	5 000970007
T8	48	16	5 000970008
T9	48	16	5 000970009
T10	51	17	5 000970010
T15	54	18	5 000970015
T20	57	19	5 000970020
T25	60	20	5 000970025
T27	64	21	5 000970027
T30	70	24	5 000970030
T40	76	26	5 000970040
T45	83	29	5 000970045
T50	95	32	5 000970050
T55	108	35	5 000970055
T60	120	38	5 000970060



97TX/ST8
T9-T10-T15-T20-T25
T27-T30-T40

1 000970640



97TX/G8
T9-T10-T15-T20-T25
T27-T30-T40

1 000970645



97TX/BG8
T9-T10-T15-T20-T25-T27-T30-T40

1 000970368



97TX/SC8
T9-T10-T15-T20-T25
T27-T30-T40

1 000970064

97TX/SCV 1 000970985



97TX/B13
T6-T7-T8-T9-T10-T15-T20
T25-T27-T30-T40-T45-T50
96N/BV

1 000970650

1 000960651

97BTX

chiavi maschio piegate
con un'estremità sferica
per viti con impronta Torx®

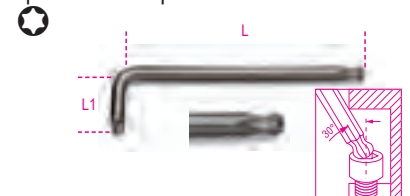

	L mm	L1 mm	
T9	80	16	5 000970109
T10	86	17	5 000970110
T15	90	18	5 000970115

	L	L1		
	mm	mm		
T20	95	19	5	000970120
T25	100	20	5	000970125
T27	105	21	5	000970127
T30	114	24	5	000970130
T40	124	26	5	000970140
T45	133	28	5	000970145
T50	152	32	3	000970150
T55	164	35	3	000970155



97BTX/SC8
T9-T10-T15-T20-T25-T27-T30-T40
97BTX/SCV

1 000970164
1 000970983



97BTX/B8
T9-T10-T15-T20-T25
T27-T30-T40
96N/BV

1 000970159
1 000960651

97RTX

chiavi maschio piegate
per viti con impronta
Tamper Resistant Torx®



	L	L1		
	mm	mm		
T9	56	16	5	000970209
T10	62	17	5	000970210
T15	72	17	5	000970215
T20	83	18	5	000970220
T25	90	18	5	000970225
T27	100	20	5	000970227
T30	105	24	5	000970230
T40	112	26	5	000970240



97RTX/SC8
T9-T10-T15-T20-T25
T27-T30-T40
97RTX/SCV

1 000970263
1 000970984

Beta



97RTX/B8
T9-T10-T15-T20-T25
T27-T30-T40
96N/BV

1 000970260
1 000960651

97TTX

chiavi maschio piegate
con impugnatura
per viti con impronta Torx®

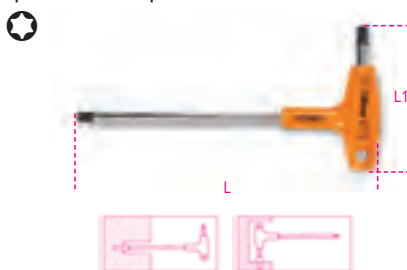

	L	L1		
	mm	mm		
T6	130	52	3	000970706
T7	130	52	3	000970707
T8	139	52	3	000970708
T9	139	52	3	000970709
T10	179	70	3	000970710
T15	179	70	3	000970715
T20	179	70	3	000970720
T25	179	70	3	000970725
T27	200	84	3	000970727
T30	200	84	3	000970730
T40	221	103	3	000970740
T45	236	106	2	000970745
T50	255	117	2	000970750



97TTX/D6
T10-T15-T20-T25-T30-T40
97TTX/S13
T6-T7-T8-T9-T10-T15-T20-T25
T27-T30-T40-T45-T50

1 000970791
1 000970813



97TTX/SP11
T8-T9-T10-T15-T20-T25
T27-T30-T40-T45-T50
96T/SPV

1 000970840
1 000960958

98XZN

chiavi a profilo XZN®



DIN 6523

	L	L1		
	mm	mm		
M5	72	25	5	000980005
M6	80	28	5	000980006
M8	90	32	5	000980008
M10	100	36	5	000980010
M12	112	40	5	000980012
M14	125	45	5	000980014
M16	140	55	5	000980016



98XZN/B5
M5-M6-M8-M10-M12
96N/BV

1 000980650
1 000960651

99

chiavi a settore con nasello quadro
per ghiera



UNI 6752

	A		
mm	mm		
12-14	1,5	3	000990012
16-18-20	1,8	3	000990016
22-25-28	1,8	3	000990022
30-32	2,1	3	000990030
34-36-38	2,4	3	000990034
40-42	2,4	3	000990040
45-50	2,5	3	000990045
52-55-58	2,5	3	000990052
62-65	3,1	3	000990062
68-70-75	3,1	3	000990068
80-85-90	3,8	2	000990080
92-95	4,3	2	000990092
98-100	4,3	2	000990098
105-110-115	4,4	1	000990105
120-125-130	4,9	1	000990120
135-145	6,0	1	000990135
155-165	6,0	1	000990155

99SQ

chiavi a settore articolate
con nasello quadro



	B		
mm	mm		
15-35	2,7	2	000990215
35-50	3,5	2	000990235
50-80	4,7	2	000990250
80-120	6,2	2	000990280
120-180	7,8	2	000990290

99ST

chiavi a settore articolate con nasello tondo



mm	∅ mm	B mm		
15-35	3,0	2,5	2	000990315
35-50	4,0	4,5	2	000990335
50-80	5,0	5,0	2	000990350
80-120	6,0	7,0	2	000990380
120-180	8,0	9,0	2	000990390

99 VN/...

nasello di ricambio per 99ST

	∅ mm			
99VN/15	15-35	1	000990295	
99VN/35	35-50	1	000990296	
99VN/50	50-80	1	000990297	
99VN/80	80-120	1	000990298	
99VN/120	120-180	1	000990299	

100

chiave a compasso con naselli tondi



∅ mm	L mm	∅ min-max mm		
4,9-5,9	250	18÷100	1	001000001
6,9-7,9				

100/KIT

naselli di ricambio per art. 100



100/KIT	1	001000010
---------	---	-----------

111

chiavi regolabili a rullino cromate con scala graduata

- Rotazione destrorsa del rullino
- Scala millimetrata e in pollici



DIN 3117 ISO 6787

L mm	L "	A max mm		
100	4	15	3	001110010
150	6	24	3	001110015
200	8	28	3	001110020
250	10	34	3	001110025
300	12	35	3	001110030
380	15	45	3	001110038
450	18	54	2	001110045
600	24	62	1	001110060

111N

chiavi regolabili a rullino fosfatate con scala graduata

- Rotazione sinistrorsa del rullino
- Con scala millimetrata e in pollici



DIN 3117 ISO 6787

L mm	L "	A max mm		
100	4	15	3	001110210
150	6	24	3	001110215
200	8	28	3	001110220
250	10	34	3	001110225
300	12	35	3	001110230
380	15	45	3	001110238
450	18	54	2	001110245

111G

chiavi regolabili a rullino con scala graduata cromate con impugnatura

- Rotazione destrorsa del rullino
- Con scala millimetrata e in pollici
- Impugnatura ergonomica



DIN 3117 ISO 6787

L mm	L "	A max mm		
200	8	28	3	001110620
250	10	34	3	001110625
300	12	35	2	001110630

120

chiavi poligonali aperte a cricchetto



∅ mm	L mm		
10	135	1	001200010
11	135	1	001200011
12	135	1	001200012
13	135	1	001200013
14	135	1	001200014
17	185	1	001200017
19	185	1	001200019
22	230	1	001200022
24	230	1	001200024
27	230	1	001200027
30	320	1	001200030
32	320	1	001200032



120/B6	1	001200050
10-11-13		
17-19-22 mm		
120/BV	1	001200051

123E1/4

adattatore portainserti 1/4" per chiavi a cricchetto 10 mm



∅ mm	L mm		
10	20,6	1	001230010

123Q1/4

adattatore a sgancio rapido 1/4" per chiavi a cricchetto 10 mm



∅ mm	L mm		
10	17,5	1	001230310

123Q3/8

adattatore a sgancio rapido 3/8" per chiavi a cricchetto 13 mm



∅ mm	L mm		
13	22,5	1	001230313

123Q1/2

adattatore a sgancio rapido 1/2" per chiavi a cricchetto 19 mm



∅ mm	L mm		
19	30,5	1	001230319

123/K4

kit di 4 adattatori per chiavi a cricchetto:
1 adattatore per bits
3 adattatori a sgancio rapido



123/K4	1	001230504
--------	---	-----------

142

chiavi combinate a cricchetto reversibile



mm	L mm		
6x6	136	3	001420006
7x7	136	3	001420007
8x8	136	3	001420008
9x9	143	3	001420009
10x10	159	3	001420010
11x11	168	3	001420011
12x12	174	3	001420012
13x13	180	3	001420013
14x14	190	2	001420014
15x15	200	2	001420015
16x16	216	2	001420016
17x17	233	2	001420017
18x18	239	2	001420018
19x19	248	2	001420019
22x22	285	1	001420022
24x24	325	1	001420024
27x27	355	1	001420027
30x30	420	1	001420030
32x32	420	1	001420032
* 36x36	480	1	001420036

* modello diritto senza invertitore



142/B6	8-10-13-14-17-19 mm	1	001420066
142/BV6		1	001420076
142/B9	8-10-11-12-13-14-15-17-19 mm	1	001420069
142/BV9		1	001420079



142/S15	6-7-8-9-10-11-12-13 14-15-16-17-18-19-22 mm	1	001420074
142/S19	6-7-8-9-10-11-12 13-14-15-16-17-18 19-22-24-27-30-32 mm	1	001420075

142/SC9I-E

serie di 9 chiavi combinate a cricchetto reversibile con supporto compatto



142/SC9I	8-10-11-12-13-14-15-17-19 mm	1	001420087
142/SCV9I		1	001420103
142/SC9E		1	001420088
142/SCV9E	8-10-11-12-13-16-17-18-19 mm	1	001420104

142AS

chiavi combinate a cricchetto reversibile



mm	L mm		
5/16x5/16	136	2	001420308
3/8x3/8	159	2	001420310
7/16x7/16	168	2	001420311
1/2x1/2	180	2	001420313
9/16x9/16	190	2	001420314
5/8x5/8	216	2	001420316
11/16x11/16	233	2	001420317
3/4x3/4	248	2	001420319



142AS/8	5/16-3/8-7/16-1/2 9/16-5/8-11/16-3/4	1	001420330
----------------	---	---	-----------

142C

chiavi combinate corte diritte a cricchetto



mm	L mm		
8x8	88	2	001420108
9x9	96	2	001420109
10x10	96	2	001420110
11x11	100	2	001420111
12x12	104	2	001420112
13x13	108	2	001420113
14x14	114	2	001420114
15x15	118	2	001420115
16x16	122	2	001420116
17x17	128	2	001420117
18x18	132	2	001420118
19x19	138	2	001420119



142C/A12	8-9-10-11-12-13-14 15-16-17-18-19 mm	1	001420175
-----------------	---	---	-----------

142SN

chiavi combinate a cricchetto snodate



mm	L mm		
7x7	136	2	001420207
8x8	136	2	001420208
9x9	143	2	001420209
10x10	160	2	001420210
11x11	168	2	001420211
12x12	174	2	001420212
13x13	180	2	001420213
14x14	193	2	001420214
15x15	200	2	001420215
16x16	216	2	001420216
17x17	233	2	001420217
18x18	239	2	001420218
19x19	250	2	001420219
22x22	285	1	001420222
24x24	325	1	001420224



142SN/S13	7-8-9-10-11-12-13-14 15-16-17-18-19 mm	1	001420263
------------------	---	---	-----------

186

chiave autoserrante a ripresa automatica per esagoni da 8 a 32 mm

ideale per viti con testa a profilo: esagonale, Spline, quadrato, Torx®; anche rovinate.



L mm	260	1	001860008
-------------	-----	---	-----------

187

chiavi esagonali apribili snodate



mm	L mm		
8x9	125	1	001870008
10x11	155	1	001870010
12x13	175	1	001870012
14x15	205	1	001870014
16x17	235	1	001870016



187/B5
8x9-10x11-12x13
14x15-16x17 mm

1 001870050

188

chiavi poligonali diritte e a cricchetto per pulegge libere alternatori



Ø mm	L mm		
10	240	2	001880010
15	322	2	001880015

192

chiavi poligonali doppie diritte a cricchetto reversibile 4 in 1



Ø mm	L mm		
8x10/12x13	160	1	001920008
16x17/18x19	230	1	001920016



192/S2		1	001920070
8x10/12x13			
16x17/18x19 mm			

194

chiave portainserti a cricchetto reversibile



Ø	L mm		
1/4x5/16	128	2	001940006

195

chiavi poligonali doppie diritte a cricchetto



Ø mm	L mm		
8x10	128	2	001950010
12x13	170	2	001950013
14x15	190	2	001950015
16x18	230	2	001950018
17x19	230	2	001950019



195/B5
8x10-12x13-14x15
16x18-17x19 mm

1 001950066

195/BV5 1 001950070

195AS

chiavi poligonali doppie diritte a cricchetto



Ø mm	L mm		
5/16x3/8	128	2	001950606
7/16x1/2	170	2	001950611
9/16x5/8	190	2	001950614
11/16x3/4	230	2	001950617



195AS/B4
5/16x3/8 - 7/16x1/2 -
9/16x5/8 - 11/16x3/4

1 001950654

195FTX/BV4 1 001950520

195P

chiavi poligonali doppie piegate a 15° a cricchetto reversibile



Ø mm	L mm		
8x10	128	2	001950210
12x13	170	2	001950213
14x15	190	2	001950215
16x18	230	2	001950218
17x19	230	2	001950219



195P/B5
8x10-12x13-14x15
16x18-17x19 mm

1 001950266

195/BV5 1 001950070

310

polifusori per saldatura tubi e raccordi in materiale plastico PE, PP, PVC e PVDF

CE



230V-650 Watt
50 Hz+60Hz
Schuko (CEE 7/7)

	Ø mm		
310/1	16+50	1	003100001
310/2	16+63	1	003100002

310B

matrici per polifusore 310



Ø mm			
16		1	003100016
20		1	003100020
25		1	003100025
32		1	003100032
40		1	003100040
50		1	003100050
63		1	003100063

310/C4

polifusore con assortimento di 3 matrici



310/C4		1	003100104
310/1+310B: Ø 20-25-32			

410x260x82 mm - 4,8 kg

310/C8

polifusore con assortimento di 7 matrici



310/C8		1	003100108
310/2+310B: Ø 16-20-25 32-40-50-63			

440x270x120 mm - 7,7 kg

Beta

311

termopiastre per saldatura tubi
in materiale plastico PE, PP, PVC e PVDF

CE

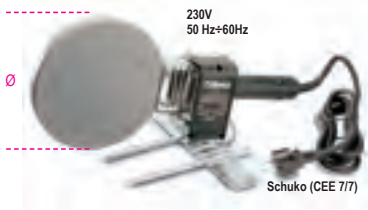

	∅ mm	Watt		
311/1	120	300	1	003110001
311/2	190	900	1	003110002

330

tagliatubi per tubi gas in acciaio



	∅ mm - "	L mm		
330/2	10÷60 1/8"÷2"	380	1	003300002
330/4	60÷115 2"÷4"	585	1	003300004

330R/A

coltelli di ricambio per 330
per tubi in acciaio

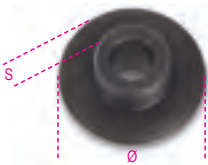

	∅ mm	S mm		
330R/A2	32	7	1	003300012
330R/A4	42	9	1	003300014

330R/I

coltello di ricambio per 330
per acciaio INOX



	∅ mm		
330R/I	32	1	003300024

331L

tagliatubi a cricchetto
per rame e leghe leggere



	∅ mm - "	L mm		
8÷29 5/16"÷1"1/8		180	1	003310008

331LR/L

coltello di ricambio per tagliatubi 331L

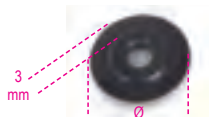

	∅ mm		
331L R/L	18	1	003310058

332

mini-tagliatubi per rame
e leghe leggere



	∅ mm - "	L mm		
3÷16 1/8"÷5/8"		59	2	003320001

334

tagliatubi per rame e leghe leggere



	∅ mm - "	L mm		
3÷30 1/8"÷1"1/8		150	1	003340001

334R

coltello di ricambio per 332-334
per rame e leghe leggere



	∅ mm		
334R	18	1	003340021

334R/I

coltello di ricambio per 332-334
per acciaio inox

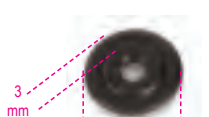

	∅ mm		
334R/I	18	1	003340023

336

tagliatubi ad avanzamento telescopico
per rame e leghe leggere



	∅ mm - "	L mm		
6÷38 1/4"÷1"1/2		160	1	003360001

338

tagliatubi ad avanzamento telescopico
rapido per rame, leghe leggere e plastica



	∅ mm - "	L mm		
6÷67 1/4"÷2"5/8		290	1	003380001

338R

coltello di ricambio per 336 e 338
per rame e leghe leggere

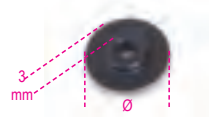

	∅ mm		
338R	18,5	1	003380022

338R/I

coltello di ricambio per 336 e 338
per acciaio inox



	∅ mm		
338R/I	21,8	1	003380023

338RP

coltello di ricambio per 336 e 338
per plastica



	∅ mm		
338RP	21,9	1	003380025

339A

tagliatubi ad avanzamento telescopico rapido per tubi di plastica



Ø	L	
mm - "	mm	
50÷127	345	1 003390011
2"÷5"		

339A/R

coltelli di ricambio per 339A



Ø		
mm		
42		1 003390061

341

pinza tagliatubi per tubi in materiale plastico



Ø	L	
mm	mm	
0÷25	190	1 003410001

341RL

lama di ricambio per 341



341RL		1 003410010

341B

cesoia a cricchetto per tubi in materiale plastico



Ø	L	
mm	mm	
0÷35	195	1 003410051

341B/RM

molla di ricambio per 341B

341B/RM		1 003410061

341B/RL

lama di ricambio per 341B



341B/RL		1 003410060

342

cesoia a cricchetto per tubi in materiale plastico



Ø	L	
mm - "	mm	
0÷42	200	1 003420030
1"5/8		

342MOL

molla di ricambio per 342

342MOL		1 003420033

342RL

lama di ricambio per 342



342RL		1 003420032

342A

cesoia a cricchetto per tubi in materiale plastico



Ø	L	
mm - "	mm	
0÷50	270	1 003420101
2"		

342A/MOL

molla di ricambio per 342A

342A/MOL		1 003420111

342A/RL

lama di ricambio per 342A



342A/RL		1 003420110

342P

cesoia a cricchetto in lega di magnesio per tubi in materiale plastico



Ø	L	
mm - "	mm	
0÷50	260	1 003420121
2"		

342P/RL

lama di ricambio per 342P



342P/RL		1 003420130

344

pinza allargatubi per tubi di piombo



L	Ø	Ø1	
mm	mm	mm	
240	53	11	1 003440001

345

utensile sbavatubi corpo in metallo

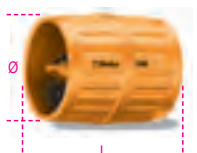

Ø	L	
mm - "	mm	
3÷42	58	5 003450001
1/8"÷1"5/8		

345U

utensile sbavatubi per inox, acciaio, rame e leghe leggere



Ø mm - "	L mm	
4÷36	60	1 003450050
5/32÷1"7/16		

345SB

sbavatore a raschietto a lama intercambiabile girevole



L mm	
150	5 003450010

345SB/R

lama di ricambio per 345SB



345SB/R	3 003450015
---------	-------------

349

attrezzo bordatubi con frizione per rame e leghe leggere

30"



Ø mm - "	
6-8-10-12-14-15-16-18	1 003490001
(1/8-3/16-1/4-5/16	
3/8-1/2-5/8-3/4)	
☞ 270x200x50 mm - 2,7 kg	

349/SMM

slitta metrica per 349



Ø mm	
6-8-10-12-14-15-16-18	1 003490011

349/SMAS

slitta in pollici per 349



Ø "	
1/8-3/16-1/4-5/16	1 003490012
3/8-1/2-5/8-3/4	

350

attrezzo bordatubi per rame e leghe leggere



Ø mm	L mm	A mm	
4-4,75-6-8	175	104	1 003500001
10-12-14			

351C

tagliatubi ed attrezzo bordatubi



351C	1 003510010
------	-------------

334	Ø 3÷30 mm (1/8"÷1"1/8)
350	Ø 4÷14 mm
351P	Ø 4-4,75-6-8-10-12-14 mm
☞ 225x150x45 mm - 1,6 kg	

351P

puntali per 350



	Ø mm	
351P4	4	3 003510101
351P4,75	4,75	3 003510102
351P6	6	3 003510103
351P8	8	3 003510104
351P10	10	3 003510105
351P12	12	3 003510106
351P14	14	3 003510107

352U

attrezzo bordatubi regolabile, per rame e leghe leggere



Ø mm - "	A mm	
5÷16	130	1 003520101
3/16÷5/8		

352C/U

tagliatubi, sbavatore ed attrezzo bordatubi regolabile



352C/U	1 003520110
--------	-------------

334	Ø 3÷30 mm (1/8"÷1"1/8)
345SB	
352U	Ø 5÷16 mm (3/16"÷5/8")
☞ 335x145x60 mm - 2120 g	

353N

pinza allargatubi a matrici ad espansione, intercambiabili



L mm	
380	1 003530201

353NM

matrici ad espansione per 353N

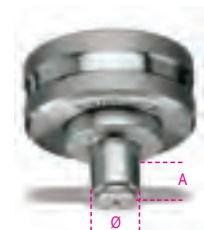

Ø mm	A mm	
10	7	1 003530210
12	10	1 003530212
14	10	1 003530214
16	12	1 003530216
18	12	1 003530218
22	13	1 003530222

353N/C6

pinza allargatubi 353N
con matrici ad espansione 353NM



353N/C6 1 003530300

353N
353NM Ø 10-12-14-16-18-22 mm
420x185x60 mm - 2,2 kg

355

chiave per raccordi radiatori
a cinque gradazioni

12"



Ø"	L mm		
3/8"-1/2"	90	2	003550001
3/4"-1"			

357F3

dima a tre file
per installazione attacchi sanitari



Ø"	L mm		
3/8" / 1/2"	90÷220	1	003570100

357R/F3

fiala di ricambio per 357F3



357 R/F3 1 003570101

358

attrezzi per smussare esternamente
tubi in materiale plastico



	Ø mm		
358/1	16÷110	1	003580001
358/2	40÷250	1	003580002

358RL

lama di ricambio per 358/1 e 358/2



358RL 1 003580011

359

chiave universale per pilette



Ø"	L mm	A mm		
1"÷1"1/4	160	140	1	003590001

359CH

adattatore per pilette
con grata a croce per 359



Ø"	L mm		
1"1/2	74	1	003590005

360

giratubi modello stillson



L mm	Ø max"	Ø max mm		
250	1" gas	34	1	003600025
350	1"1/2 gas	49	1	003600035
450	2" gas	60	1	003600045
600	2"1/2 gas	76	1	003600060
900	3"1/2 gas	102	1	003600090

360R/...

kit ricambio per 360
composto da ganascia mobile e ghiera.

360R/250	1	003600225
360R/350	1	003600235
360R/450	1	003600245
360R/600	1	003600260
360R/900	1	003600290

362

giratubi modello americano



L mm	Ø max"	Ø max mm		
200	1" gas	34	1	003620020
250	1"1/2 gas	49	1	003620025
300	2" gas	60	1	003620030
350	2" gas	60	1	003620035
450	2"1/2 gas	76	1	003620045
600	3" gas	90	1	003620060
900	5" gas	140	1	003620090

362R/...

kit ricambi per 362
composto da: ganascia fissa; ganascia mobile;
ghiera; spina di fissaggio.

362R/200	1	003620220
362R/250	1	003620225
362R/300	1	003620230
362R/350	1	003620235
362R/450	1	003620245
362R/600	1	003620260

363

giratubi modello americano
corpo in lega leggera



L mm	Ø max"	Ø max mm		
350	2" gas	60	1	003630035
450	2"1/2 gas	76	1	003630045
600	3" gas	90	1	003630060
900	5" gas	140	1	003630090
1200	6" gas	165	1	003630120

363R/...

kit ricambi per 363
composto da: ganascia fissa; ganascia mobile;
ghiera; spina di fissaggio.

363R/350	1	003630235
363R/450	1	003630245
363R/600	1	003630260
363R/900	1	003630290

 **Beta**

365

giratubi modello frontale
corpo in lega leggera

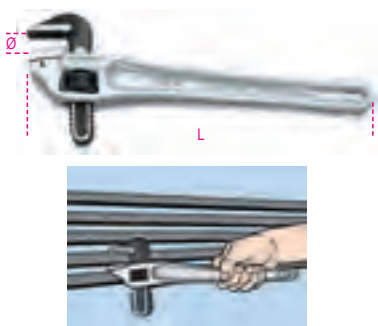

L mm	Ø max "	Ø max mm		
350	2" gas	60	1	003650035
450	2"1/2 gas	76	1	003650045

365R/...

kit ricambi per 365
composto da: ganaschia fissa; ganaschia mobile;
ghiera; spina di fissaggio.

365R/350	1	003650235
365R/450	1	003650245

366

giratubi tipo leggero



L mm	Ø max "	Ø max mm		
175	1" gas	34	1	003660017
225	1"1/2 gas	49	1	003660022
275	2" gas	60	1	003660027
300	2"1/2 gas	76	1	003660030
350	3" gas	90	1	003660035

374

giratubi modello svedese
ganasse sottili a 45°



DIN 5234

L mm	Ø max "	Ø max mm		
240	1/2" gas	21	1	003740024
320	1" gas	34	1	003740032
410	1"1/2 gas	49	1	003740041
550	2" gas	60	1	003740055
630	3" gas	90	1	003740063

375

giratubi modello svedese
ganasse parallele a 45°



DIN 5234

L mm	Ø max "	Ø max mm		
320	1" gas	34	1	003750032
410	1"1/2 gas	49	1	003750041
550	2" gas	60	1	003750055

376

giratubi modello svedese
ganasse piane a 90°



DIN 5234

L mm	Ø max "	Ø max mm		
320	1" gas	34	1	003760032
410	1"1/2 gas	49	1	003760041
550	2" gas	60	1	003760055
630	3" gas	90	1	003760063

378

giratubi modello svedese
ganasse sottili a 45°



DIN 5234

L mm	Ø max "	Ø max mm		
250	1/2" gas	21	1	003780025
320	1" gas	34	1	003780032
410	1"1/2 gas	49	1	003780041
550	2" gas	60	1	003780055
650	3" gas	90	1	003780065

374R/...

KIT ricambi completi per 374 - 375 - 376 - 378
composto da ghiera e fermaghiera

374R/240	1	003740724
374/240-378/250		
374R/320	1	003740732
374/320-375/320-376/320-378/320		
374R/410	1	003740741
374/410-375/410-376/410-378/410		
374R/550	1	003740755
374/550-375/550-376/550-378/550		
374R/630	1	003740763
374/630-378/650		

383

giratubi reversibili a nastro



	Ø max "	Ø max mm	L mm		
383/1	3" gas	90	300	1	003830001
383/2	8" gas	220	300	1	003830002

383R

nastri di ricambio per 383



	S mm		
383R/1	27	1	003830010
383R/2	27	1	003830015

384

giratubi reversibile a catena



Ø max "	Ø max mm	L mm		
4" gas	115	300	1	003840032

384RC

catena di ricambio per 384



384RC	1	003840033
-------	---	-----------

386A

giratubi reversibili a catena
modello pesante



	Ø max "	L mm		
386A/3	4" gas	900	1	003860003
	115 mm			
386A/4	6" gas	900	1	003860004
	168 mm			
386A/5	8" gas	1100	1	003860005
	220 mm			
386A/6	12" gas	1300	1	003860006
	324 mm			

386A/RC

catene di ricambio per 386A



386A3/RC	1	003860013
386A4/RC	1	003860014
386A5/RC	1	003860015
386A6/RC	1	003860016

Beta

388

attrezzi curvatubi
per rame, lega leggera e acciaio dolce

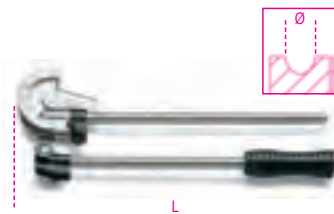

Ø mm	L mm		
6	305	1	003880006
8	315	1	003880008
10	350	1	003880010
12	360	1	003880012
14	455	1	003880014
15	465	1	003880015
16	465	1	003880016

388A

pinza curvatubi
per rame e lega leggera



	Ø mm	L mm		
388A/1	6-8-10	220	1	003880051
388A/2	1/4"-5/16"-3/8"	220	1	003880055

388C/C8

attrezzo curvatubi con 7 matrici
per rame e lega leggera



	Ø mm	L mm		
388C/C8	10-12-14-16 18-20-22	220	1	003880200

400x330x110 mm - 3,6 kg

392C

pinza regolabile per sifoni



Ø mm	L mm		
25÷65	260	1	003920100

392RG/C

coppia di copri-ganasce di ricambio per 392C



392RG/C 1 003920101

393

pinza per dadi rubinetto



L
mm
270 1 003930001

395

chiave per dadi rubinetto
articolata



L
mm
240 1 003950001
15÷32 mm
5/8"÷1"1/4

395T

chiave per dadi rubinetto
articolata, telescopica



L
mm
250÷430 1 003950100
10÷32 mm
3/8"÷1"1/4

399

morse ribaltabili da banco



Ø mm	L min mm		
10÷60 mm 1/8÷2"	220	1	003990005
10÷89 mm 1/8÷3"	290	1	003990010

410

punte elicoidali cilindriche
serie corta, in acciaio HSS

rullate
R ≤ 650 N/mm²
HV ~ 750÷820



DIN 338 ISO 235

Ø mm	L mm	L1 mm		
0,50	22	6	10	004100030
1,00	34	12	10	004100040
1,25	38	16	10	004100043
1,50	40	18	10	004100046
1,75	46	22	10	004100049
2,00	49	24	10	004100052
2,25	53	27	10	004100055
2,50	57	30	10	004100058
2,75	61	33	10	004100061
3,00	61	33	10	004100064
3,20	65	36	10	004100066
3,25	65	36	10	004100067
3,50	70	39	10	004100070
3,75	70	39	10	004100073
4,00	75	43	10	004100076
4,20	75	43	10	004100078
4,25	75	43	10	004100079
4,50	80	47	10	004100082
4,75	80	47	10	004100085
5,00	86	52	10	004100088
5,25	86	52	10	004100091
5,50	93	57	10	004100094
5,75	93	57	10	004100097
6,00	93	57	10	004100100
6,25	101	63	10	004100103
6,50	101	63	10	004100106
6,75	109	69	10	004100109
7,00	109	69	10	004100112
7,50	109	69	10	004100118
8,00	117	75	10	004100124
8,50	117	75	10	004100130
9,00	125	81	5	004100136
9,50	125	81	5	004100142
10,00	133	87	5	004100148
10,50	133	87	5	004100172
11,00	142	94	5	004100184
11,50	142	94	5	004100196
12,00	151	101	5	004100210
12,50	151	101	5	004100222
13,00	151	101	5	004100234
14,00	160	108	5	004100242
15,00	169	114	5	004100250
16,00	178	120	5	004100258
17,00	186	125	3	004100262
18,00	194	130	3	004100266
19,00	202	135	3	004100270
20,00	210	140	3	004100274



410/SP19	Ø 1÷10 x 0,5 mm	1	004100419
410/SPV1		1	004100420
410/SP25		1	004100425
410/SPV2	Ø 1÷13 x 0,5 mm	1	004100426



410/SEL19
 $\varnothing 1 \pm 10 \times 0,5 \text{ mm}$

1 004100418

410MIX/SEL19

serie di 13 punte 410
 e 6 punte con inserto in metallo duro



410MIX/SEL19

1 004100417



$\varnothing 1 - 1,5 - 2 - 2,5 - 3 - 3,5 - 4$
 $4,5 - 5 - 5,5 - 6 - 8 - 10 \text{ mm}$

$\varnothing 4 - 5 - 6 - 8 - 9 - 10 \text{ mm}$

410A

punte elicoidali cilindriche
 serie corta, in acciaio HSS rullate

$R \leq 650 \text{ N/mm}^2$
 $HV \sim 750 \div 820$



\varnothing mm	L mm	L1 mm	
13,50	160	108	5 004100281
14,00	160	108	5 004100283
14,50	169	114	5 004100285
15,00	169	114	5 004100287
15,50	178	120	5 004100289
16,00	178	120	5 004100291
16,50	186	125	3 004100292
17,00	186	125	3 004100293
17,50	194	130	3 004100294
18,00	194	130	3 004100295
18,50	202	135	3 004100296
19,00	202	135	3 004100297
19,50	210	140	3 004100298
20,00	210	140	3 004100299

410AS

punte elicoidali cilindriche
 serie corta, in acciaio HSS

rullate
 $R \leq 650 \text{ N/mm}^2$
 $HV \sim 750 \div 820$



ANSI B94

\varnothing "	L mm	L1 mm	
1/16	48	22	10 004100371
5/64	51	25	10 004100372
3/32	57	32	10 004100373
7/64	67	38	10 004100374
1/8	70	41	10 004100375
9/64	73	44	10 004100376
5/32	79	51	10 004100377
11/64	83	54	10 004100378
3/16	89	59	10 004100379
13/64	92	62	10 004100380
7/32	95	64	10 004100381
15/64	98	67	10 004100382
1/4	102	70	10 004100383
17/64	105	73	10 004100384
9/32	108	75	10 004100385
19/64	111	78	10 004100386
5/16	114	81	10 004100387
21/64	117	84	10 004100388
11/32	121	87	5 004100389
23/64	124	89	5 004100390
3/8	127	92	5 004100391



410AS/SP21

$\varnothing 1/16 - 5/64 - 3/32 - 7/64$
 $1/8 - 9/64 - 5/32 - 11/64 - 3/16$
 $13/64 - 7/32 - 15/64 - 1/4$
 $17/64 - 9/32 - 19/64 - 5/16$
 $21/64 - 11/32 - 23/64 - 3/8$

1 004100429

410AS/SPV1

1 004100430



410AS/SEL21

$\varnothing 1/16 - 5/64 - 3/32 - 7/64$
 $1/8 - 9/64 - 5/32 - 11/64 - 3/16$
 $13/64 - 7/32 - 15/64 - 1/4$
 $17/64 - 9/32 - 19/64 - 5/16$
 $21/64 - 11/32 - 23/64 - 3/8$

1 004100433



412

punte elicoidali cilindriche
 serie corta, in acciaio HSS
 rettificate lucide

$R \leq 700 \text{ N/mm}^2$
 $HV \sim 750 \div 820$

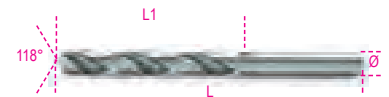

DIN 338 ISO 235

\varnothing mm	L mm	L1 mm	
0,50	22	6	10 004120030
1,00	34	12	10 004120040
1,25	38	16	10 004120043
1,50	40	18	10 004120046
1,75	46	22	10 004120049
2,00	49	24	10 004120052
2,25	53	27	10 004120055
2,50	57	30	10 004120058
2,75	61	33	10 004120061
3,00	61	33	10 004120064
3,25	65	36	10 004120067
3,50	70	39	10 004120070
3,75	70	39	10 004120073
4,00	75	43	10 004120076
4,25	75	43	10 004120079
4,50	80	47	10 004120082
4,75	80	47	10 004120085
5,00	86	52	10 004120088
5,25	86	52	10 004120091
5,50	93	57	10 004120094
5,75	93	57	10 004120097
6,00	93	57	10 004120100
6,25	101	63	10 004120103
6,50	101	63	10 004120106
6,75	109	69	10 004120109
7,00	109	69	10 004120112
7,25	109	69	5 004120115
7,50	109	69	5 004120118
7,75	117	75	5 004120121
8,00	117	75	5 004120124
8,25	117	75	5 004120127
8,50	117	75	5 004120130
8,75	125	81	5 004120133
9,00	125	81	5 004120136
9,25	125	81	5 004120139
9,50	125	81	5 004120142
9,75	133	87	5 004120145
10,00	133	87	5 004120148
10,25	133	87	5 004120149
10,50	133	87	5 004120150
10,75	142	94	5 004120151
11,00	142	94	5 004120152
11,25	142	94	5 004120153
11,50	142	94	5 004120154
11,75	142	94	5 004120155
12,00	151	94	5 004120156
12,25	151	101	5 004120157
12,50	151	101	5 004120158
12,75	151	101	5 004120159
13,00	151	101	5 004120160



412/SP19	1	004120419
Ø 1÷10 x 0,5 mm		
412/SPV1	1	004120420
412/SP25	1	004120425
Ø 1÷13 x 0,5 mm		
412/SPV2	1	004120426
412/SP49	1	004120449
Ø 1÷13 x 0,25 mm		
412/SPV4	1	004120451

412/C150



412/C150	1	004120450
-----------------	---	-----------

412	Ø 3 mm	n.
	Ø 1 - 1,5 - 2 - 2,5 - 3 - 3,5 - 4 - 4,5 - 5 mm	20
	Ø 5,5 - 6 - 6,5 - 7 - 7,5 - 8 - 8,5 - 9 - 9,5 - 10 mm	5

365x230x47 mm - 3,3 kg



412/SP91	1	004120452
Ø 1÷10 x 0,10 mm		



412A

punte elicoidali cilindriche
serie corta, in acciaio HSS
rettificate brunite
R ≤ 700 N/mm²
HV ~ 750÷820



DIN 338 ISO 235

Ø mm	L mm	L1 mm		
13,50	160	108	3	004120202
14,00	160	108	3	004120204
14,50	169	114	3	004120206
15,00	169	114	3	004120208
15,50	178	120	3	004120210
16,00	178	120	3	004120212
16,50	186	125	1	004120213
17,00	186	125	1	004120214
17,50	194	130	1	004120215
18,00	194	130	1	004120216
18,50	202	135	1	004120217
19,00	202	135	1	004120218
19,50	210	140	1	004120219
20,00	210	140	1	004120220

412L

punte elicoidali cilindriche
serie lunga, in acciaio HSS
rettificate brunite
R ≤ 700 N/mm²
HV ~ 750÷820



Ø mm	L mm	L1 mm		
2,00	85	56	10	004120232
2,50	95	62	10	004120234
3,00	100	66	10	004120236
3,50	112	73	10	004120238
4,00	119	78	10	004120240
4,50	126	82	10	004120242
5,00	132	87	10	004120244
5,50	139	91	10	004120246
6,00	139	91	10	004120248
6,50	148	97	5	004120250
7,00	156	102	5	004120252
8,00	165	109	5	004120256
9,00	175	115	5	004120260
10,00	184	121	5	004120264

414

punte elicoidali cilindriche
serie corta, in acciaio HSS-TiN
rettificate
R ≤ 900 N/mm²
HV 0,05 ~ 2500



DIN 338 ISO 235

Ø mm	L mm	L1 mm		
1,00	34	12	10	004140040
1,25	38	16	10	004140042
1,50	40	18	10	004140046
1,75	46	22	10	004140048
2,00	49	24	10	004140052
2,25	53	27	10	004140054
2,50	57	30	10	004140058
2,75	61	33	10	004140060
3,00	61	33	10	004140064
3,25	65	36	10	004140066
3,50	70	39	10	004140070
3,75	70	39	10	004140072

Ø mm	L mm	L1 mm		
4,00	75	43	10	004140076
4,25	75	43	10	004140078
4,50	80	47	10	004140082
4,75	80	47	10	004140084
5,00	86	52	10	004140088
5,25	86	52	10	004140090
5,50	93	57	10	004140094
5,75	93	57	10	004140096
6,00	93	57	10	004140100
6,25	101	63	10	004140102
6,50	101	63	10	004140106
6,75	109	69	10	004140108
7,00	109	69	10	004140112
7,25	109	69	5	004140114
7,50	109	69	5	004140118
7,75	117	75	5	004140120
8,00	117	75	5	004140124
8,25	117	75	5	004140125
8,50	117	75	5	004140130
8,75	125	81	5	004140132
9,00	125	81	5	004140136
9,25	125	81	5	004140138
9,50	125	81	5	004140142
9,75	133	87	5	004140144
10,00	133	87	5	004140148
10,50	133	87	5	004140150
11,00	142	94	5	004140152
11,50	142	94	5	004140154
12,00	151	101	5	004140156
12,50	151	101	5	004140158
13,00	151	101	5	004140160



414/SP19	1	004140419
Ø 1÷10 x 0,5 mm		
414/SPV1	1	004140420
414/SP25	1	004140425
Ø 1÷13 x 0,5 mm		
414/SPV2	1	004140426
414/SP49	1	004140429
Ø 1÷13 x 0,25 mm		
414/SPV4	1	004140430



414/C116



414/C116 1 004140450

414	Ø	n.
	1 - 1,5 - 2 - 2,5 - 3 - 3,5 - 4 - 4,5 - 5 mm	10
	Ø 5,5 - 6 - 6,5 - 7 - 7,5 - 8 mm	3
	Ø 8,5 - 9 - 9,5 - 10 mm	2

365x230x47 mm - 2,7 Kg

415

punte elicoidali cilindriche serie corta, in acciaio HSS-CO 8% rettificato

R ≤ 1400 N/mm²
HV ~ 850÷920



DIN 338 ISO 235

Ø mm	L mm	L1 mm	n.
0,50	22	6	10 004150029
1,00	34	12	10 004150040
1,25	38	16	10 004150043
1,50	40	18	10 004150046
1,75	46	22	10 004150049
2,00	49	24	10 004150052
2,25	53	27	10 004150055
2,50	57	30	10 004150058
2,75	61	33	10 004150061
3,00	61	33	10 004150064
3,25	65	36	10 004150067
3,50	70	39	10 004150070
3,75	70	39	10 004150073
4,00	75	43	10 004150076
4,25	75	43	10 004150079
4,50	80	47	10 004150082
4,75	80	47	10 004150085
5,00	86	52	10 004150088
5,25	86	52	10 004150091
5,50	93	57	10 004150094
5,75	93	57	10 004150097
6,00	93	57	10 004150100
6,25	101	63	10 004150103
6,50	101	63	10 004150106
6,75	109	69	10 004150109
7,00	109	69	10 004150112
7,25	109	69	5 004150115
7,50	109	69	5 004150118
7,75	117	75	5 004150121
8,00	117	75	5 004150124
8,25	117	75	5 004150127
8,50	117	75	5 004150130
8,75	125	81	5 004150133
9,00	125	81	5 004150136
9,25	125	81	5 004150139
9,50	125	81	5 004150142
9,75	133	87	5 004150145
10,00	133	87	5 004150148
10,25	133	87	5 004150149
10,50	133	87	5 004150150
10,75	142	94	5 004150151
11,00	142	94	5 004150152
11,25	142	94	5 004150153
11,50	142	94	5 004150154
11,75	142	94	5 004150155
12,00	151	101	5 004150156
12,25	151	101	5 004150157
12,50	151	101	5 004150158

Ø mm	L mm	L1 mm	n.
12,75	151	101	5 004150159
13,00	151	101	5 004150160
14,00	160	108	3 004150164
15,00	169	114	3 004150168
16,00	178	120	3 004150172
17,00	186	125	1 004150174
18,00	194	130	1 004150176
19,00	202	135	1 004150178
20,00	210	140	1 004150180



415/SP19	Ø	n.
	1÷10 x 0,5 mm	1 004150419
415/SPV1		1 004150420
415/SP25		1 004150425
	Ø 1÷13 x 0,5 mm	
415/SPV2		1 004150426
415/SP49		1 004150431
	Ø 1÷13 x 0,25 mm	
415/SPV4		1 004150432

415/C116



415/C116 1 004150450

415	Ø	n.
	1 - 1,5 - 2 - 2,5 - 3 - 3,5 - 4 - 4,5 - 5 mm	10
	Ø 5,5 - 6 - 6,5 - 7 - 7,5 - 8 mm	3
	Ø 8,5 - 9 - 9,5 - 10 mm	2

365x230x47 mm - 2,7 kg



415/SP91 1 004150460
Ø 1÷10 x 0,10 mm

416

punta cilindrica con affilatura speciale a doppia coppia di taglieri

R ≤ 900 N/mm²
HV ~ 820÷850



VELOCITÀ DI TAGLIO SUPERIORE

DIN 338

Ø mm	L mm	L1 mm	n.
1,00	34	12	10 004160010
1,50	40	18	10 004160015
2,00	49	24	10 004160020
2,50	57	30	10 004160025
3,00	61	33	10 004160030
3,50	70	39	10 004160035
4,00	75	43	10 004160040
4,50	80	47	10 004160045
5,00	86	52	10 004160050
5,50	93	57	10 004160055
6,00	93	57	10 004160060
6,50	101	63	10 004160065
7,00	109	69	10 004160070
7,50	109	69	5 004160075
8,00	117	75	5 004160080
8,50	117	75	5 004160085
9,00	125	81	5 004160090
9,50	125	81	5 004160095
10,00	133	87	5 004160100

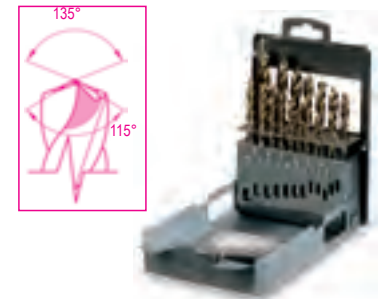

416/SP19 1 004160419
Ø 1÷10 x 0,5 mm

417

punte elicoidali cilindriche per muratura serie corta, in acciaio fresato con placchetta in metallo duro



DIN 8039

Ø mm	L mm	n.
3	70	10 004170003
4	75	10 004170004
5	85	10 004170005
5L	150	5 004170105
6	100	10 004170007
6L	150	5 004170106
7	120	10 004170009
8	120	10 004170010
8L	200	5 004170113
9	120	10 004170011
10	120	10 004170012
10L	200	5 004170120
12	150	10 004170014
12L	200	5 004170125
14	150	5 004170016
16	150	5 004170018



417/SP8
Ø 3-4-5-6-8-9-10-12 mm

1 004170100

419

punte per muratura
corpo fresato con placchetta
in metallo duro



DIN 8039

ØxL mm	
4x110	10 004190002
5x110	10 004190004
5x160	10 004190006
6x110	10 004190012
6x160	10 004190014
6x210	10 004190016
7x160	10 004190028
8x110	10 004190030
8x160	10 004190032
8x210	10 004190034
8x260	10 004190036
8x460	10 004190042
9x160	5 004190044
10x160	5 004190050
10x210	5 004190052
10x260	5 004190054
10x310	5 004190056
10x460	5 004190060
12x160	5 004190064
12x210	5 004190066
12x260	5 004190068
12x460	5 004190074
14x160	3 004190086
14x260	3 004190090
14x310	3 004190092
14x460	3 004190096
16x210	3 004190112
16x250	3 004190114
16x300	3 004190116
16x450	3 004190120
18x250	1 004190124
20x310	1 004190128

423

punte speciali
per punti di saldatura
in acciaio HSS, rettificato



Ø mm	L mm	
6	66	5 004230006
7	74	5 004230007
8	79	5 004230008
10	89	5 004230010

423A

frese speciali per punti
di saldatura, in acciaio HSS
rettificate



DIN 1412/E

Ø mm	L mm	
6,5	40	1 004230015
8,0	40	1 004230020

424

punte coniche per forare
ed allargare
in acciaio HSS



	L mm	Ø mm	D mm	
424/1	58	3÷14	6	2 004240001
424/2	63	6÷20	8	2 004240002
424/3	60	16÷30	10	2 004240003
424/4	80	3÷22	8	1 004240004
424/5	102	3÷31	10	1 004240005
424/6	86	26÷40	13	1 004240006
424/7	89	36÷50	13	1 004240007
424/8	90	40÷61	13	1 004240008



424/SP3
424/1+424/2+424/3
Ø 3÷30 mm
424/SPV
1 004240019
1 004240020

425

frese coniche a gradino
in acciaio HSS



	L mm	Ø mm	S mm	D mm	
425/1	70	4÷12	1	6	2 004250010
425/2	55	4÷12	2	6	2 004250012
425/3	85	4÷20	2	10	2 004250015
425/4	85	12÷20	1	10	1 004250016
425/5	97	20÷30	1	10	1 004250017
425/6	75	4÷30	2	10	1 004250020
425/7	97	30÷40	1	13	1 004250025
425/8	100	40÷50	1	13	1 004250029



425/SP3
425/1+425/3+425/6
Ø 4÷30 mm
425/SPV
1 004250030
1 004250035

426

frese a sbavare ed incassare
a tre taglienti
in acciaio HSS



DIN 335-C

GR	Ø mm	L mm	Ø1 mm	
1	4,3	44	4	3 004260001
2	5,3	44	4	3 004260002
3	6,3	44	5	3 004260003
4	7,3	44	6	3 004260004
5	8,3	50	6	3 004260005
6	9,4	50	6	3 004260006
7	10,4	54	6	3 004260007
8	12,4	54	8	3 004260008
9	15,0	56	10	3 004260009
10	16,5	60	10	3 004260010
11	20,5	63	10	3 004260011
12	25,0	66	10	3 004260012
13	28,0	71	13	3 004260013
14	31,0	71	13	3 004260014



426/SP6
GR 3-5-7-8-10-11
Ø 6,3÷20,5 mm
426/SPV
1 004260030
1 004260035

426SB

frese a sbavare e svasare
in acciaio HSS



	L	Ø1	Ø2		
	mm	mm	mm		
426/SB1	45	10-(2÷5)	6	1	004260101
426/SB2	48	14-(5÷10)	8	1	004260102
426/SB3	6521-(10÷15)	10		1	004260103
426/SB4	8528-(15÷20)	12		1	004260104
426/SB5	10235-(20÷25)	15		1	004260105
426/SB6	11544-(25÷30)	15		1	004260106



426SB/SP4	1	004260130
426/SB1-426/SB2		
426/SB3-426/SB4		
Ø 2÷20 mm		
426SB/SPV1	1	004260135

426MD

lime rotative in metallo duro

taglio incrociato HM6



	L	Ø		
	mm	mm		
426MD/CP8	63	8	1	004260512
426MD/CP12	70	12	1	004260522
426MD/CT8	64	8	1	004260513
426MD/CT12	69	12	1	004260523
426MD/F8	64	8	1	004260514
426MD/F12	69	12	1	004260524
426MD/T8	65	8	1	004260516
426MD/T12	69	12	1	004260526
426MD/S8	52	8	1	004260518
426MD/S12	54	12	1	004260528
426MD/FA8	62	8	1	004260519
426MD/FA12	70	12	1	004260529



426MD/SP10	1	004260510
426MD/CP-426MD/CT-426MD/F		
426MD/T-426MD/S		
Ø 8-12 mm		

427

estrattori coni Morse



DIN 317

GR	L	A		
	mm	mm		
0	92	13	3	004270000
1-2	140	19	3	004270002
3	190	25	3	004270003
4	225	30	3	004270004
5-6	260	35	3	004270006

428FP

maschi a macchina per fori passanti
passo grosso
in acciaio HSS

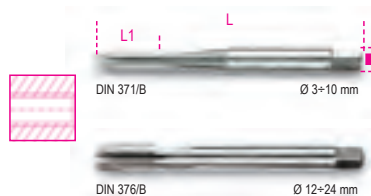

ISO 529

M	■	L	L1		
mm	mm	mm	mm		
3x0,5	2,7	56	11	10	004280003
4x0,7	3,4	63	13	10	004280004
5x0,8	4,9	70	16	10	004280005
6x1	4,9	80	19	10	004280006
8x1,25	6,2	90	22	10	004280008
10x1,5	8,0	100	24	10	004280010
12x1,75	7,0	110	29	5	004280012
14x2	9,0	110	30	5	004280014
16x2	9,0	110	30	5	004280016
18x2,5	11,0	125	34	3	004280018
20x2,5	12,0	140	34	3	004280020
22x2,5	14,5	140	34	3	004280022
24x3	14,5	160	38	3	004280024

428FC

maschi a macchina per fori ciechi
passo grosso
in acciaio HSS



ISO 529

M	■	L	L1		
mm	mm	mm	mm		
3x0,5	2,7	56	11	10	004280103
4x0,7	3,4	63	13	10	004280104
5x0,8	4,9	70	16	10	004280105
6x1	4,9	80	19	10	004280106
8x1,25	6,2	90	22	10	004280108
10x1,5	8,0	100	24	10	004280110
12x1,75	7,0	110	29	5	004280112
14x2	9,0	110	30	5	004280114
16x2	9,0	110	30	5	004280116
18x2,5	11,0	125	34	3	004280118
20x2,5	12,0	140	34	3	004280120
22x2,5	14,5	140	34	3	004280122
24x3	14,5	160	38	3	004280124

428/C14

assortimento di 14 maschi a macchina
428FP+428FC



428/C14	1	004280201
428FP M3÷12		
428FC M3÷12		
428/SPV	1	004280202

429FP

maschi a macchina per fori passanti
passo grosso
in acciaio HSS-CO 5%

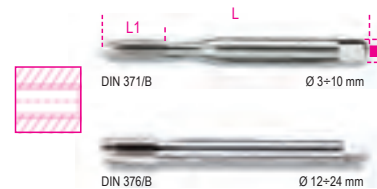

ISO 529

M	■	L	L1		
mm	mm	mm	mm		
3x0,5	2,7	56	11	5	004290003
4x0,7	3,4	63	13	5	004290004
5x0,8	4,9	70	16	5	004290005
6x1	4,9	80	19	5	004290006
8x1,25	6,2	90	22	5	004290008
10x1,5	8,0	100	24	5	004290010
12x1,75	7,0	110	29	5	004290012
14x2	9,0	110	30	5	004290014

429FC

maschi a macchina per fori ciechi
passo grosso
in acciaio HSS-CO 5%

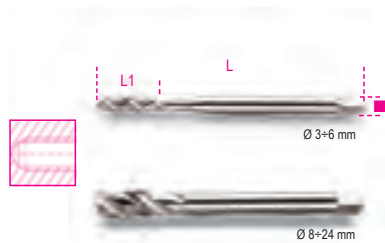

ISO 529

M	mm	L	L1		
3x0,5	2,7	56	11	5	004290103
4x0,7	3,4	63	13	5	004290104
5x0,8	4,9	70	16	5	004290105
6x1	4,9	80	19	5	004290106
8x1,25	6,2	90	22	5	004290108
10x1,5	8,0	100	24	5	004290110
12x1,75	7,0	110	29	5	004290112
14x2	9,0	110	30	5	004290114

429/C14

assortimento di 14 maschi a macchina
429FP+429FC



429/C14	1	004290201
429FP M3÷12		
429FC M3÷12		
428/SPV	1	004280202

430

serie di 3 maschi a mano
sgrossatore, intermedio, finitore
passo grosso, in acciaio al cromo



ISO 529

M	mm	L	L1		
2x0,4	2,5	36	11	5	004300002
3x0,5	2,5	40	12	5	004300003
4x0,7	3,0	45	14	5	004300004
5x0,8	4,0	48	16	5	004300005
6x1	5,0	50	18	5	004300006
7x1	4,5	50	18	5	004300007
8x1,25	5,0	56	22	3	004300008
9x1,25	5,5	63	22	3	004300009
10x1,5	6,0	70	25	3	004300010
11x1,5	7,0	70	25	3	004300011
12x1,75	7,0	75	30	3	004300012
14x2	8,0	80	32	3	004300014
16x2	10,0	80	32	3	004300016
18x2,5	11,0	95	40	1	004300018
20x2,5	12,0	95	40	1	004300020
22x2,5	14,5	100	40	1	004300022
24x3	14,5	110	50	1	004300024



430/SP21	1	004300201
M 3-4-5-6-8-10-12		
430/SPV	1	004300202

430ASW

serie di 3 maschi a mano
sgrossatore, intermedio, finitore
Whitworth, in acciaio al cromo



DIN 352

BSW	mm	L	L1		
1/8x40	2,7	40	12	5	004300031
5/32x32	3,4	45	14	5	004300032
3/16x24	4,3	48	18	5	004300033
1/4x20	4,9	50	22	5	004300034
5/16x18	4,9	56	25	3	004300035
3/8x16	5,5	70	28	3	004300036
7/16x14	6,2	70	30	3	004300037
1/2x12	7,0	75	32	3	004300038
9/16x12	9,0	80	32	1	004300039
5/8x11	9,0	80	38	1	004300040
3/4x10	11,0	95	40	1	004300041
7/8x9	14,5	100	40	1	004300042
1"x8	16,0	110	50	1	004300043

430ASC

serie di 3 maschi a mano
sgrossatore, intermedio, finitore
UNC, in acciaio al cromo

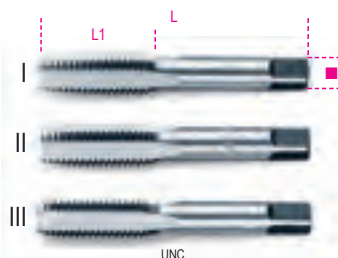

ANSI B1.1

UNC	mm	L	L1		
1/4x20	4,9	70	30	5	004300051
5/16x18	4,9	70	30	5	004300052
3/8x16	5,5	75	35	3	004300053
7/16x14	6,2	80	40	3	004300054
1/2x13	7,0	85	45	3	004300055
9/16x12	9,0	90	45	3	004300056
5/8x11	9,0	100	47	3	004300057
3/4x10	11,0	110	50	3	004300058
7/8x9	14,5	120	60	1	004300059
1"x8	16,0	130	60	1	004300060

431

serie di 3 maschi a mano
sgrossatore, intermedio, finitore
passo grosso, in acciaio HSS



DIN 352 UNI 4535

M	mm	L	L1		
3x0,5	2,5	40	12	5	004310003
4x0,7	3,0	45	14	5	004310004
5x0,8	4,0	48	16	5	004310005
6x1	5,0	50	18	5	004310006
7x1	5,0	50	18	5	004310007
8x1,25	5,0	56	22	3	004310008
10x1,5	6,0	70	25	3	004310010
12x1,75	7,0	75	30	3	004310012
14x2	9,0	80	32	1	004310014
16x2	9,0	80	32	1	004310016
18x2,5	11,0	95	40	1	004310018
20x2,5	12,0	95	40	1	004310020
22x2,5	12,0	100	40	1	004310022
24x3	14,5	110	50	1	004310024



431/SP21	1	004310201
M 3-4-5-6-8-10-12		
431/SPV	1	004310202

433

serie di 2 maschi a mano
sgrossatore e finitore
passo fine, in acciaio al cromo

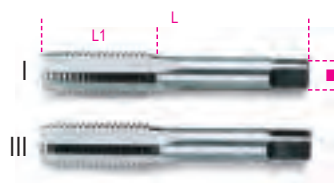

DIN 2181 UNI 4535

M	mm	L	L1		
6x0,75	4,5	48	16	5	004330201
7x0,75	4,5	56	18	5	004330202
8x0,75	5,0	50	16	5	004330203
8x1	5,0	56	16	5	004330204
9x0,75	6,0	63	22	5	004330205
9x1	6,0	63	22	5	004330206
10x0,75	6,5	63	18	5	004330207
10x1	6,5	63	18	5	004330208
10x1,25	6,5	63	18	5	004330209
11x0,75	7,0	70	25	3	004330210
11x1	7,0	70	25	3	004330211
11x1,25	7,0	70	25	3	004330212
12x0,75	7,0	70	20	3	004330213
12x1	7,0	70	20	3	004330214
12x1,25	7,0	70	20	3	004330215
12x1,5	7,0	70	20	3	004330216
14x1	8,0	80	32	1	004330217

M	mm	L	L1		
14x1,25	8,0	80	32	1	004330218
14x1,5	8,0	80	32	1	004330219
16x1	10,0	80	32	1	004330220
16x1,5	10,0	80	32	1	004330221
18x1,5	11,0	95	40	1	004330222
18x2	11,0	80	25	1	004330223
20x1,5	14,5	80	22	1	004330224
22x1,5	14,5	80	22	1	004330225
24x1,5	14,5	80	22	1	004330226
24x2	14,5	80	22	1	004330227

433ASF

serie di 2 maschi a mano
UNF, passo fine
in acciaio al cromo

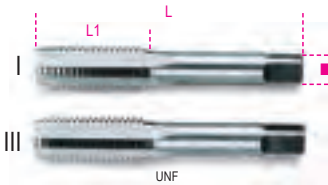

ANSI B.1

UNF	mm	L	L1		
1/4x28	4,9	70	30	5	004330301
5/16x24	4,9	70	30	5	004330302
3/8x24	5,5	75	35	3	004330303
7/16x20	6,2	80	40	3	004330304
1/2x20	7,0	85	45	3	004330305
9/16x18	9,0	90	45	3	004330306
5/8x18	9,0	100	47	3	004330307
3/4x16	11,0	110	50	3	004330308
7/8x14	14,5	120	60	1	004330309
1"x12	16,0	130	60	1	004330310

433ASG

serie di 2 maschi a mano
filettatura GAS cilindrica
in acciaio al cromo



DIN 5157

GAS	mm	L	L1		
1/8x28	5,5	65	18	1	004330401
1/4x19	9,0	70	24	1	004330402
3/8x19	9,0	75	25	1	004330403
1/2x14	12,0	80	31	1	004330405
3/4x14	16,0	90	33	1	004330408
1"x11	20,0	100	39	1	004330410

434

serie di 2 maschi a mano
sgrossatore e finitore
passo fine, in acciaio HSS



DIN 2181 UNI 4535

M	mm	L	L1		
6x0,75	4,5	48	16	5	004340001
8x0,75	5,0	56	16	5	004340003
8x1	5,0	56	16	5	004340004
10x0,75	6,5	63	18	5	004340007
10x1	6,5	63	18	5	004340008

M	mm	L	L1		
10x1,25	6,5	63	18	5	004340009
12x1	7,0	70	20	3	004340014
12x1,25	7,0	70	20	3	004340015
12x1,5	7,0	70	20	3	004340016
13x1,5	9,0	70	20	1	004340017
14x1	9,0	70	20	1	004340018
14x1,25	9,0	70	20	1	004340019
14x1,5	9,0	70	20	1	004340020
15x1,5	9,0	70	20	1	004340021
16x1	9,0	70	20	1	004340022
16x1,5	9,0	70	20	1	004340023
18x1,5	11,0	80	22	1	004340024
18x2	11,0	90	25	1	004340025
20x1,25	12,0	80	22	1	004340026
20x1,5	12,0	80	22	1	004340027
20x2	12,0	90	25	1	004340028
22x1,5	14,5	80	22	1	004340029
24x1	14,5	80	22	1	004340030
24x1,5	14,5	80	22	1	004340031
24x2	14,5	80	22	1	004340032

435

giramaschi regolabili
corpo in acciaio



DIN 1814

	mm	L		
435/0	2÷5	140	3	004350007
	M2÷M8			
435/1	2÷6	180	2	004350009
	M3÷M10			
435/1,5	2,5÷6	180	2	004350011
	M3÷M12			
435/2	3÷7	260	2	004350013
	M4÷M12			
435/3	4÷12	380	1	004350020
	M5÷M20			
435/4	5,5÷16	490	1	004350027
	M9÷M27			
435/5	7÷18	620	1	004350032
	M13÷M32			

435G

giramaschi regolabili
corpo in lega leggera

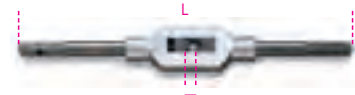

DIN 1814

	mm	L		
435G/0	2÷5	130	5	004350108
	M1÷M8			
435G/1	2÷6	190	5	004350110
	M1÷M10			
435G/1,5	2÷7	175	5	004350112
	M2÷M12			
435G/2	3,4÷7	280	5	004350114
	M4÷M12			
435G/3	4,9÷12	380	2	004350121
	M5÷M20			
435G/4	7÷16	500	2	004350127
	M11÷M27			
435G/5	7÷18	700	1	004350132
	M13÷M32			
435G/6	11÷24	800	1	004350142
	M18÷M42			



436

giramaschi a cricchetto
reversibile

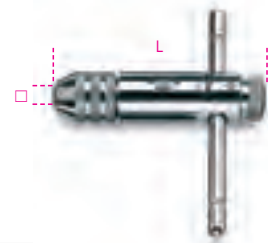

	mm	L		
436/1	2÷5	85	5	004360002
	M3÷M8			
436/2	4,6÷8	110	5	004360004
	M5÷M12			

436L

giramaschi a cricchetto
reversibile, tipo lungo



	mm	L		
436L/1	2÷5	245	2	004360012
	M3÷M8			
436L/2	4,6÷8	295	2	004360014
	M5÷M12			

436R

morsetti di ricambio per 436 e 436L

436R/1			1	004360022
436R/2			1	004360024

437C

set ripristino filettature candela danneggiate,
M14x1,25 mm

• altezza elicoidi: 8,40 - 12,40 - 16,40 mm. (5 pz per misura)



437C			1	004370100

437C/...

elicoidi in acciaio inossidabile per 437C



H mm		
8.4	1	004370108
12.4	1	004370112
16.4	1	004370116

I prezzi indicati sono relativi a 10 pezzi

437C/RM14

maschi filetti candele M14x1,25



437C/RM14	1	004370124
-----------	---	-----------

437U/09

assortimento per il ripristino delle filettature danneggiate



25 x M5, M6, M8, M10
10 x M12

437U/09	1	004370550
M5x0,8		
M6x1,0		
M8x1,25		
M10x1,5		
M12x1,75		

370x230x55 mm - 2 Kg

437U/E-M...

elicoidi in acciaio inossidabile



H mm		
M5	7.5	1 004370555
M6	9	1 004370556
M8	12	1 004370558
M10	15	1 004370560
M12	18	1 004370562

I prezzi indicati sono relativi a 25 pezzi
(10 per la misura M12)

437U/PM

punte e maschi per 437U/09



M5	1	004370565
M6	1	004370566
M8	1	004370568
M10	1	004370570
M12	1	004370572

437K/8

assortimento per ripristino filetti semiassi

- permette di ripassare e ravvivare il filetto originale
- Incluse nel kit:
- misure metriche:
20x1,25 - 20x1,5 - 22x1,00 - 22x1,5 - 24x1,5 - 24x2,00
- misure in pollici
3/4x20 - 13/16x20



32 mm

437K/8	1	004370020
--------	---	-----------

200x110x30 mm

437K/16

assortimento per il ripristino delle filettature danneggiate dei supporti pinze freno M9x1,25



437K/16	1	004370016
---------	---	-----------

210x150x50 mm

437K/33

assortimento per il ripristino delle filettature candele danneggiate

Boccole:

M8x1,0 - M10x1,0 - M10x1,25 - M12x1,25

Maschi:

M8x1,0 - M10x1,0 - M10x1,25 - M12x1,0 - M12x1,25 - M14x1,25



437K/33	1	004370133
---------	---	-----------

210x150x50 mm

438A

serie di punte per forare, filettare e svasare; in acciaio HSS

- M3 - M4 - M5 - M6 - M8 - M10
- con portainseriti magnetico



438A	1	004380010
------	---	-----------

438...

punte per forare, filettare e svasare

in acciaio HSS, attacco 1/4"



	S max mm	
M3	3	2 004380103
M4	4	2 004380104
M5	5	2 004380105
M6	6	2 004380106
M8	8	2 004380108
M10	10	2 004380110

Beta

440

filiere tonde **passo grosso**
in acciaio al cromo

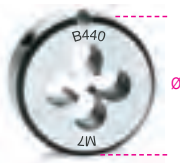

UNI EN 22568

M	Ø mm		
2x0,4	25,4	5	004400002
3x0,5	25,4	5	004400003
4x0,7	25,4	5	004400004
5x0,8	25,4	5	004400005
6x1	25,4	5	004400006
7x1	25,4	5	004400007
8x1,25	25,4	5	004400008
9x1,25	25,4	5	004400009
10x1,5	25,4	5	004400010
12x1,75	25,4	5	004400012

440A

filiere tonde **passo grosso**
in acciaio al cromo

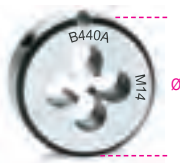

UNI EN 22568

M	Ø mm		
10x1,5	38,1	3	004400110
11x1,5	38,1	3	004400111
12x1,75	38,1	3	004400112
14x2	38,1	3	004400114
16x2	38,1	3	004400116
18x2,5	38,1	3	004400118
20x2,5	38,1	3	004400120

440B

filiere tonde **passo grosso**
in acciaio al cromo



UNI EN 22568

M	Ø mm		
18x2,5	50,8	3	004400122
20x2,5	50,8	3	004400124
22x2,5	50,8	3	004400126
24x3	50,8	3	004400128

440ASW

filiere tonde **Whitworth**
in acciaio al cromo



BSW	Ø mm		
1/8x40	25,4	5	004400201
5/32x32	25,4	5	004400202
3/16x24	25,4	5	004400203
1/4x20	25,4	5	004400204
5/16x18	25,4	5	004400205
3/8x16	38,1	3	004400206
7/16x14	38,1	3	004400207
1/2x12	38,1	3	004400208
9/16x12	38,1	3	004400209
5/8x11	50,8	3	004400210
3/4x10	50,8	3	004400211
7/8x9	50,8	3	004400212
1"x8	50,8	3	004400213

440ASC

filiere tonde, **UNC**
passo grosso, in acciaio al cromo



UNC	Ø mm		
1/4x20	25,4	5	004400221
5/16x18	25,4	5	004400222
3/8x16	38,1	3	004400223
7/16x14	38,1	3	004400224
1/2x13	38,1	3	004400225
9/16x12	38,1	3	004400226
5/8x11	50,8	3	004400227
3/4x10	50,8	3	004400228
7/8x9	50,8	3	004400229
1"x8	50,8	3	004400230

440ASF

filiere tonde, **UNF**
passo fine, in acciaio al cromo

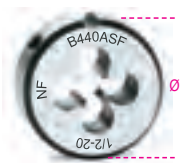

ANSI B1.1

UNF	Ø mm		
1/4x28	25,4	5	004400241
5/16x24	25,4	5	004400242
3/8x24	38,1	3	004400243
7/16x20	38,1	3	004400244
1/2x20	38,1	3	004400245
9/16x18	38,1	3	004400246
5/8x18	50,8	3	004400247
3/4x16	50,8	3	004400248
7/8x14	50,8	3	004400249
1"x12	50,8	3	004400250

440ASG

filiere tonde, filettatura **GAS** cilindrica
in acciaio al cromo



UNI EN 22568

GAS	Ø mm		
1/8x28	38,1	3	004400255
1/4x19	38,1	3	004400256
3/8x19	38,1	3	004400257
1/2x14	50,8	3	004400259
3/4x14	50,8	3	004400260
1"x11	63,5	3	004400261

441

filiere tonde **passo fine**
in acciaio al cromo

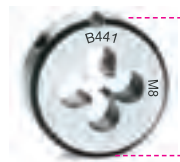

UNI EN 22568

M	Ø mm		
6x0,75	25,4	5	004410004
7x0,75	25,4	5	004410005
8x0,75	25,4	5	004410006
8x1	25,4	5	004410007
9x0,75	25,4	5	004410008
9x1	25,4	5	004410009

441A

filiere tonde **passo fine**
in acciaio al cromo

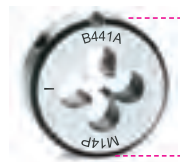

UNI EN 22568

M	Ø mm		
10x0,75	38,1	3	004410100
10x1	38,1	3	004410101
10x1,25	38,1	3	004410102
11x0,75	38,1	3	004410103
11x1	38,1	3	004410104
11x1,25	38,1	3	004410105
12x0,75	38,1	3	004410106
12x1	38,1	3	004410107
12x1,25	38,1	3	004410108
12x1,5	38,1	3	004410109
14x1	38,1	3	004410110
14x1,25	38,1	3	004410111
14x1,5	38,1	3	004410112
16x1	38,1	3	004410113
16x1,5	38,1	3	004410114
18x1,5	38,1	3	004410115

441B

filiere tonde **passo fine**
in acciaio al cromo



UNI EN 22568

M	Ø mm		
18x1,5	50,8	3	004410117
18x2	50,8	3	004410118
20x1,5	50,8	3	004410119
22x1,5	50,8	3	004410120
24x1,5	50,8	3	004410121
24x2	50,8	3	004410122

442

filiere tonde **passo grosso**
in acciaio HSS



UNI EN 22568

M	ØxS mm		
3x0,5	20x5	3	004420003
4x0,7	20x5	3	004420004
5x0,8	20x7	3	004420005
6x1	20x7	3	004420006
7x1	25x9	3	004420007
8x1,25	25x9	3	004420008
10x1,5	30x11	3	004420010
12x1,75	38x14	3	004420012
14x2	38x14	1	004420014
16x2	45x18	1	004420016
18x2,5	45x18	1	004420018
20x2,5	45x18	1	004420020
22x2,5	55x22	1	004420022
24x3	55x22	1	004420024

443

filiere tonde, **passo fine**
in acciaio HSS



UNI EN 22568

M	ØxS mm		
6x0,75	20x7	1	004430107
8x0,75	25x9	1	004430110
8x1	25x9	1	004430111
10x0,75	30x11	1	004430113
10x1	30x11	1	004430114
10x1,25	30x11	1	004430115
12x1	38x10	1	004430116
12x1,25	38x10	1	004430117
12x1,5	38x10	1	004430118
13x1,5	38x10	1	004430119
14x1	38x10	1	004430120
14x1,25	38x10	1	004430121
14x1,5	38x10	1	004430122
15x1,5	38x10	1	004430123
16x1	45x14	1	004430124
16x1,5	45x14	1	004430125
18x1,5	45x14	1	004430127

M	ØxS mm		
20x1,25	45x14	1	004430129
20x1,5	45x14	1	004430130
20x2	45x14	1	004430131
22x1,5	55x16	1	004430132
24x1	55x16	1	004430133
24x1,5	55x16	1	004430135
24x2	55x16	1	004430136

444

girafiliera, corpo in acciaio



DIN 225

	Ø mm	L mm		
444	20x5	215	5	004440005
444/0	20x7	215	5	004440007
444/1	25,4	225	5	004440025
444/1A	25x9	225	5	004440027
444/1B	30x11	300	5	004440030
444/C	38x10	315	3	004440033
444/1C	38x14	315	3	004440035
444/2	38,1x14	360	3	004440038
444/1D	45x14	455	1	004440045
444/2D	45x18	455	1	004440046
444/3	50,8	555	1	004440050
444/4	55x16	555	1	004440055
444/5A	63,5	630	1	004440057

444G

girafiliera, corpo in lega leggera



UNI EN 22568

	Ø mm	L mm		
444G/A	16x5	160	5	004440103
444G	20x5	200	5	004440105
444G/0	20x7	200	5	004440107
444G/1	25,4	210	5	004440125
444G/1A	25x9	224	5	004440127
444G/1B	30x11	280	5	004440130
444G/C	38x10	315	3	004440133
444G/1C	38x14	315	3	004440135
444G/2	38,1	320	3	004440138
444G/1D	45x14	450	1	004440145
444G/2D	45x18	450	1	004440146
444G/3	50,8	500	1	004440150
444G/4	55x16	560	1	004440155
444G/5A	63,5	620	1	004440163
444G/6	65x18	630	1	004440165

446/C30

assortimento di maschi e filiere,
in acciaio al cromo e accessori
in cassetta di legno



446/C30

1 004460055

325x220x35 mm - 3,2 Kg

430 M mm	440 M mm		
3x0,5	3x0,5	435/1,5	444/1
4x0,7	4x0,7		
5x0,8	5x0,8		
6x1	6x1		
8x1,25	8x1,25		
10x1,5	10x1,5		
12x1,75	12x1,75		

446/C48

assortimento di maschi e filiere,
in acciaio al cromo e accessori
in cassetta di legno



446/C48

1 004460057

580x300x50 mm - 5 Kg

430 M mm	440 M mm	440A M mm		
3x0,5	3x0,5	10x1,5	435/1	444/1
4x0,7	4x0,7	12x1,75	435/3	444/2
5x0,8	5x0,8	14x2		
6x1	6x1	16x2		
8x1,25	8x1,25	18x2,5		
10x1,5		20x2,5		
12x1,75				
14x2				
16x2				
18x2,5				
20x2,5				

Beta

446/C110

assortimento di maschi e filiere, in acciaio al cromo e accessori per autoriparazione in cassetta di legno



446/C110 1 004460060

500x337x60 mm - 8,1 Kg

430 M mm	433 M mm	440/440A, 441/441A M mm	441/441A M mm
2x0,4	6x0,75	2x0,4	6x0,75
3x0,5	7x0,75	3x0,5	7x0,75
4x0,7	8x0,75	4x0,7	8x0,75
5x0,8	8x1	5x0,8	8x1
6x1	9x0,75	6x1	9x0,75
7x1	9x1	7x1	9x1
8x1,25	10x0,75	8x1,25	10x0,75
9x1,25	10x1	9x1,25	10x1
10x1,5	10x1,25	10x1,5	10x1,25
11x1,5	11x0,75	11x1,5	11x0,75
12x1,75	11x1	12x1,75	11x1
14x2	11x1,25	14x2	11x1,25
16x2	12x0,75	16x2	12x0,75
	12x1		12x1
	12x1,25		12x1,25
	12x1,5		12x1,5
	14x1		14x1
	14x1,25		14x1,25
	14x1,5		14x1,5
	16x1		16x1
	16x1,5		16x1,5
	18x1,5		18x1,5

435/0 435/3	444/1 444/2	436/1

446ASF/C29

assortimento di maschi e filiere in acciaio al cromo e accessori filettatura UNF in cassetta di legno



446ASF/C29 1 004460070

660x410x50 mm - 6 Kg

433ASF	440ASF		
1/4	1/4	435/1,5	444/1
5/16	5/16	435/3	444/2
3/8	3/8		444/3
7/16	7/16		
1/2	1/2		
9/16	9/16		
5/8	5/8		
3/4	3/4		

446ASW/C36

assortimento di maschi e filiere in acciaio al cromo e accessori filettatura Whitworth in cassetta di legno



446ASW/C36 1 004460075

525x310x50 mm - 3,4 Kg

430ASW	440ASW		
1/8	1/8	435/1,5	444/1
5/32	5/32	435/2	444/2
3/16	3/16		
1/4	1/4		
5/16	5/16		
3/8	3/8		
7/16	7/16		
1/2	1/2		

446ASC/C37

assortimento di maschi e filiere in acciaio al cromo e accessori filettatura UNC in cassetta di legno



446ASC/C37 1 004460080

660x410x50 mm - 6,7 Kg

430ASC	440ASC		
1/4	1/4	435/1,5	444/1
5/16	5/16	435/3	444/2
3/8	3/8		444/3
7/16	7/16		
1/2	1/2		
9/16	9/16		
5/8	5/8		
3/4	3/4		

446ASG/C23

assortimento di maschi e filiere in acciaio al cromo e accessori filettatura GAS cilindrica in cassetta di legno



446ASG/C23 1 004460085

700x430x70 mm - 9,8 Kg

433ASG	440ASG		
1/8	1/8	435/3	444/2
1/4	1/4	435/5	444/3
3/8	3/8		444/5A
1/2	1/2		
3/4	3/4		
1"	1"		

 **Beta**

447/C37

assortimento di maschi e filiere
in acciaio HSS e accessori
in cassetta di metallo



447/C37

380x185x35 mm - 3,9 Kg

1 004470055

431 M mm	442 M mm		
3x0,5	3x0,5	435/0	444
4x0,7	4x0,7	435/2	444/0
5x0,8	5x0,8		444/1A
6x1	6x1		444/1B
8x1,25	8x1,25		444/1C
10x1,5	10x1,5		
12x1,75	12x1,75		

436/1	0,5x3x75
-------	----------

447/C53

assortimento di maschi e filiere
in acciaio HSS e accessori
in cassetta di metallo



447/C53

500x235x50 mm - 9 Kg

1 004470060

431 M mm	442 M mm			
3x0,5	3x0,5	435/1,5	444	436/1
4x0,7	4x0,7	435/3	444/0	
5x0,8	5x0,8		444/1A	
6x1	6x1		444/1B	
8x1,25	8x1,25		444/1C	
10x1,5	10x1,5		444/2D	
12x1,75	12x1,75			
14x2	14x2			
16x2	16x2			
18x2,5	18x2,5			
20x2,5	20x2,5			

447/C70

assortimento di maschi e filiere
in acciaio HSS e accessori
per autoriparazione ed industria
in cassetta di legno



447/C70

510x340x70 mm - 7,5 Kg

1 004470065

431 M mm	434 M mm	442 M mm	443 M mm
3x0,5	8x1	3x0,5	8x1
4x0,7	10x1,25	4x0,7	10x1,25
5x0,8	12x1,25	5x0,8	12x1,25
6x1	12x1,5	6x1	12x1,5
7x1	14x1,25	7x1	14x1,25
8x1,25	14x1,5	8x1,25	14x1,5
10x1,5	16x1,5	10x1,5	16x1,5
12x1,75		12x1,75	
14x2		14x2	
16x2		16x2	

435/0	444	436/1
435/3	444/0	
	444/1A	
	444/1B	
	444/1C	
	444/1D	

450

seghe a tazza
in acciaio HSS-Co 8%

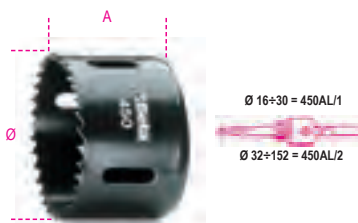

HSS-Co 8%

Ø mm	Ø "	A mm	
16	(5/8)	57	1 004500016
17	(11/16)	57	1 004500017
19	(3/4)	51	1 004500019
20	-	51	1 004500020
21	(13/16)	51	1 004500021
22	(7/8)	51	1 004500022
24	(15/16)	51	1 004500024
25	(1")	51	1 004500025
27	(1 1/16)	51	1 004500027
29	(1 1/8)	51	1 004500029
30	(1 3/16)	51	1 004500030
32	(1 1/4)	51	1 004500032
33	(1 5/16)	51	1 004500033
35	(1 3/8)	51	1 004500035
37	(1 7/16)	51	1 004500037
38	(1 1/2)	44	1 004500038

Ø mm	Ø "	A mm	
40	(1 9/16)	44	1 004500040
41	(1 5/8)	44	1 004500041
43	(1 11/16)	44	1 004500043
44	(1 3/4)	44	1 004500044
46	(1 13/16)	44	1 004500046
48	(1 7/8)	44	1 004500048
51	(2")	44	1 004500051
52	(2 1/16)	44	1 004500052
54	(2 1/8)	44	1 004500054
57	(2 1/4)	44	1 004500057
59	(2 5/16)	44	1 004500059
60	(2 3/8)	44	1 004500060
64	(2 1/2)	44	1 004500064
65	(2 9/16)	44	1 004500065
67	(2 5/8)	44	1 004500067
68	-	44	1 004500068
70	(2 3/4)	44	1 004500070
73	(2 7/8)	44	1 004500073
76	(3")	44	1 004500076
79	(3 1/8)	44	1 004500079
83	(3 1/4)	44	1 004500083
86	(3 3/8)	44	1 004500086
89	(3 1/2)	44	1 004500089
92	(3 5/8)	44	1 004500092
95	(3 3/4)	44	1 004500095
98	(3 7/8)	44	1 004500098
102	(4")	44	1 004500102
105	(4 1/8)	44	1 004500105
108	(4 1/4)	44	1 004500108
111	(4 3/8)	44	1 004500111
114	(4 1/2)	44	1 004500114
121	(4 3/4)	44	1 004500121
127	(5")	44	1 004500127
140	(5 1/2)	44	1 004500140
152	(6")	44	1 004500152

450AL

alberi per seghe a tazza

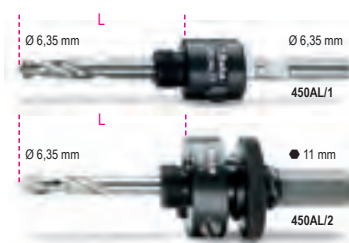

	Ø mm	L mm	
450AL/1	16±30	54	1 004500210
450AL/2	32±152	70	1 004500215

450AD

adattatore per alberi 450AL/1



	Ø mm	
450AD	32±51	1 004500230

Beta

450PA/1

punta per centrare
in acciaio HSS
per alberi 450AL/1



ØxL
mm
6,35x105

1 004500252

450PA/2

punta per centrare
in acciaio HSS
per alberi 450AL/2

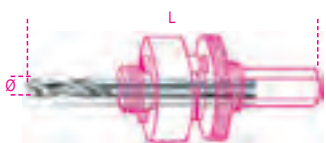

ØxL
mm
6,35x80

1 004500253

450PR

prolunga per seghe a tazza



L
mm
305

1 004500255

450/C9

assortimento di seghe a tazza
ed accessori per elettricisti



HSS-Co 8%

450/C9

1 004500305

450 Ø 22 - 29 - 35 - 44 - 51 - 64 mm
450AL /1 - /2
450AD
220x160x60 mm - 1,6 Kg

450/C13

assortimento di seghe a tazza
ed accessori per installatori



HSS-Co 8%

450/C13

1 004500310

450 Ø 19 - 22 - 29 - 35 - 38
44 - 51 - 57 - 64 mm
450AL /1 - /2
450PA/1
450AD
215x180x65 mm - 1,8 Kg

450/C21

assortimento di seghe a tazza
ed accessori per uso industriale



HSS-Co 8%

450/C21

1 004500315

450 Ø 19 - 22 - 29 - 35 - 38
44 - 51 - 57 - 64 - 76
83 - 92 - 95 - 105 - 114 mm
450AL /1 - /2
450PA /1 - /2
450PR
450AD
420x280x60 mm - 7 Kg

451

frese a tazza
in acciaio HSS
interamente rettificate

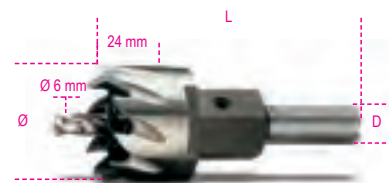

Ø mm	L mm	D mm	
12	85	8	1 004510012
13	85	8	1 004510013
14	85	8	1 004510014
15	85	10	1 004510015
16	85	10	1 004510016
17	85	10	1 004510017
18	85	10	1 004510018
19	85	10	1 004510019
20	85	10	1 004510020
21	85	10	1 004510021
22	85	10	1 004510022
23	85	10	1 004510023
24	85	10	1 004510024
25	85	10	1 004510025
26	90	10	1 004510026
27	90	10	1 004510027
28	90	10	1 004510028
29	90	10	1 004510029
30	90	10	1 004510030
31	90	10	1 004510031
32	90	10	1 004510032
33	90	10	1 004510033
34	90	10	1 004510034
35	90	10	1 004510035
36	85	10	1 004510036
37	85	10	1 004510037
38	85	10	1 004510038
39	85	10	1 004510039
40	85	10	1 004510040
41	85	10	1 004510041
42	85	10	1 004510042
43	85	10	1 004510043
44	85	10	1 004510044
45	85	10	1 004510045
46	85	10	1 004510046
47	85	10	1 004510047
48	85	10	1 004510048
49	85	10	1 004510049
50	85	10	1 004510050

451GA

gambi per frese a tazza 451



M	Ø mm	L mm	D mm	
10x1,25	12÷14	57	8	1 004510101
12x1,25	15÷34	57	10	1 004510102
14x1,5	35÷50	57	10	1 004510105

451PA

punta pilota per frese a tazza 451
in acciaio HSS



Ø mm	L mm	
6	53	1 004510103

451PR

prolunga per frese a tazza 451



M	Ø mm	L mm	Ø1 mm		
12x1,25	15÷34	400	13	1	004510104
14x1,5	35÷50	400	13	1	004510108

452

frese a tazza
con inserti in metallo duro

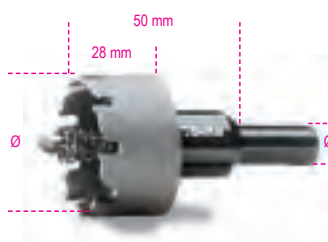

Ø mm	Ø1 mm		
15	10	1	004520015
16	10	1	004520016
17	10	1	004520017
18	10	1	004520018
19	10	1	004520019
20	10	1	004520020
21	10	1	004520021
22	10	1	004520022
23	10	1	004520023
24	10	1	004520024
25	10	1	004520025
26	10	1	004520026
27	10	1	004520027
28	10	1	004520028
29	10	1	004520029
30	10	1	004520030
31	10	1	004520031
32	10	1	004520032
33	10	1	004520033
34	10	1	004520034
35	10	1	004520035
36	10	1	004520036
37	10	1	004520037
38	10	1	004520038
39	13	1	004520039
40	13	1	004520040
41	13	1	004520041
42	13	1	004520042
43	13	1	004520043
44	13	1	004520044
45	13	1	004520045
46	13	1	004520046
47	13	1	004520047
48	13	1	004520048
49	13	1	004520049
50	13	1	004520050
55	13	1	004520055
60	13	1	004520060
65	13	1	004520065
70	13	1	004520070
75	13	1	004520075
80	13	1	004520080
85	13	1	004520085
90	13	1	004520090

452GA

gambi per frese a tazza 452



	Ø mm		
452GA/1	15÷21	1	004520125
452GA/2	22÷38	1	004520126
452GA/3	39÷100	1	004520127

560/C2

moltiplicatore di coppia e accessori
rapporto 5:1
in cassetta di plastica



Nm	Kgfm	lbf.ft	□	■	kg
1300	130	960	1/2	3/4	3,8

560/C2	1	005600020
560/2	1	005600002
560/18	1	005600018
560/19	1	005600019
560/22	1	005600022

310x275x120 mm

560/C4+

moltiplicatore di coppia
rapporto 5:1
con piede di reazione

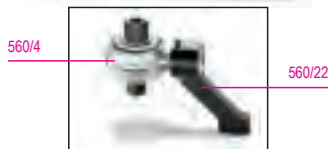

Nm	Kgfm	lbf.ft	□	■	kg
2700	270	2000	3/4	1"	5

560/C4+	1	005600042
560/4	1	005600004
560/18	1	005600018
560/22	1	005600022

310x275x120 mm

560/C6

moltiplicatori di coppia destrorsi/sinistrorsi in
valigetta di materiale plastico
rapporto 6,5:1



Nm	kgfm	lbf.ft	□	■	kg
1500	150	1106	1/2"	3/4"	6

560/C6	1	005600160
--------	---	-----------

400x260x110 mm

560/C12

moltiplicatori di coppia destrorsi/sinistrorsi in
valigetta di materiale plastico
rapporto 12:1



Nm	kgfm	lbf.ft	□	■	kg
2500	250	1844	1/2"	1"	7

560/C12	1	005600210
---------	---	-----------

400x260x110 mm

561

moltiplicatore di coppia
rapporto 5:1



Nm	kgfm	lbf.ft	□	■	kg
1000	100	740	1/2"	3/4"	4,6

561	1	005610001
-----	---	-----------

310x275x120 mm

562/1 - 562/2

moltiplicatori di coppia
rapporto 5:1

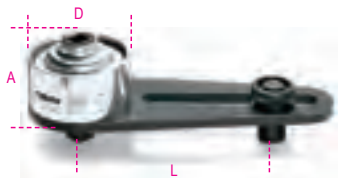

Nm	Kgfm	lbf.ft	□	■	D	A	L min	L max	kg
1700	170	1250	3/4	1"	108	95	85	220	5,3

562/1 1 005620001

Nm	Kgfm	lbf.ft	□	■	D	A	L min	L max	kg
3400	340	2500	3/4	1"	119	115	85	265	7,0

562/2 1 005620002

564/3R - 564/4R

moltiplicatori di coppia
rapporto 25:1
con dispositivo antiritorno



Nm	Kgfm	lbf.ft	□	■	D	A	L	kg
3000	300	2200	1/2	1"	108	188	155	9,2

564/3R 1 005640003

Nm	Kgfm	lbf.ft	□	■	D	A	L	kg
6000	600	4500	1/2	1 1/2"	119	235	200	15,5

564/4R 1 005640004

565/1R - 565/2R - 565/3R

moltiplicatori di coppia
rapporto 25:1
con dispositivo antiritorno

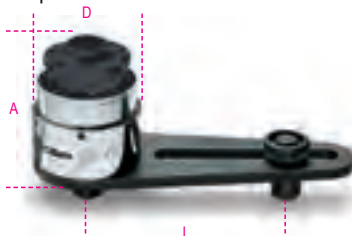

Nm	Kgfm	lbf.ft	□	■	D	A	L min	L max	kg
1700	170	1250	1/2	1"	108	125	80	215	7,7

565/1R 1 005650011

Nm	Kgfm	lbf.ft	□	■	D	A	L min	L max	kg
3400	340	2500	1/2	1"	119	145	85	265	10,1

565/2R 1 005650012

Nm	Kgfm	lbf.ft	□	■	D	A	L min	L max	kg
3400	340	2500	1/2	1 1/2"	119	145	85	265	10,7

565/3R 1 005650013

565/4R

moltiplicatore di coppia
rapporto 25:1
con dispositivo antiritorno

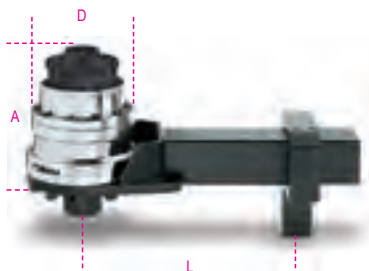

Nm	Kgfm	lbf.ft	□	■	D	A	L min	L max	kg
6000	600	4500	1/2	1 1/2"	144	180	125	335	17

565/4R 1 005650014

565/5R

moltiplicatore di coppia
rapporto 25:1
con dispositivo antiritorno

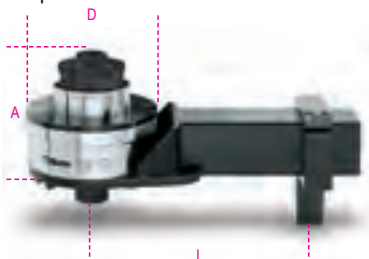

Nm	Kgfm	lbf.ft	□	■	D	A	L min	L max	kg
9500	950	7000	3/4	1 1/2"	184	180	155	355	25

565/5R 1 005650015

567/4R

moltiplicatore di coppia
rapporto 125:1
con dispositivo antiritorno



Nm	Kgfm	lbf.ft	□	■	D	A	L min	L max	kg
6000	600	4500	1/2	1 1/2"	144	210	125	335	19

567/4R 1 005670014

567/5R

moltiplicatore di coppia
rapporto 125:1
con dispositivo antiritorno

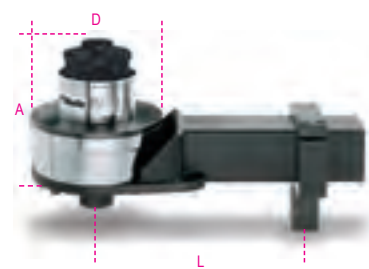

Nm	Kgfm	lbf.ft	□	■	D	A	L min	L max	kg
9500	950	7000	1/2	1 1/2"	184	210	155	350	27

567/5R 1 005670015

581

giravite dinamometrico a slittamento,
non graduato
adatto a serraggi destrorsi,
precisione di serraggio +/-6%
(per il settaggio della coppia usare
gli artt. 588 - 682)



UNI EN 26789
ISO 6789

Nm	gfm	□	g
1,2÷6	120÷600	1/4"	275

581 1 005810001

Beta

583

giravite dinamometrico a slittamento
adatto a serraggi destrorsi,
precisione di serraggio +/-6%



UNI EN 26789
ISO 6789

Nm	gfm	lbf.ft	kg
0,3÷1,5	30÷150	1/4"	240

583/1,5 1 005830015

Nm	gfm	lbf.ft	kg
0,6÷3	60÷300	1/4"	240

583/3 1 005830030

Nm	gfm	lbf.ft	kg
1,2÷6	120÷600	1/4"	350

583/6 1 005830060



583/C31

1 giravite dinamometrico, 8 chiavi a bussola
esagonali, 20 inserti per avvitatori e 2
accessori

1/4"



583/C31 1 005830931

	583/6	1.2 - 6 Nm
	900	4-5-5,5-6-7-8-9-10 mm
	860LP	0,6x4,5 - 1x5,5 - 1,2x6,5 mm
	860PH	PH1 - PH2 (x2) - PH3
	860PE	2-2,5-3-4-5 mm
	860TX	T9-T10-T15-T20-T25-T27-T30-T40
	882P/80	80 mm
	892/0	● 1/4 ■ 1/4

270x120x45 mm - 1,2 kg

588

misuratore di coppia elettronico digitale

per la verifica e il settaggio dei giravite dinamometrici artt.
581-583

Precisione di lettura: ± 1% del valore letto

CE



Nm	lbf.in	lbf.ft	kg
1÷10	10÷90	1/4"	1,8

588 1 005880001

**Tabella dei campi di impiego
delle chiavi e barre dinamometriche
a fine listino**

590 - 592

chiavi dinamometriche a lettura diretta
adatte a serraggi destrorsi e sinistrorsi
precisione di serraggio ± 4%

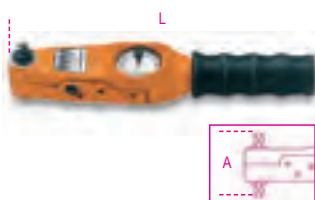

UNI EN 26789
ISO 6789

Nm	Kgfm	lbf.in	lbf.ft	A mm	L mm	kg
0,3÷4	0,03÷0,4	3÷35	1/4	60	253	0,52

590 1 005900001

Nm	Kgfm	lbf.in	lbf.ft	A mm	L mm	kg
0,5÷13,5	0,05÷1,35	4÷120	1/4	60	253	0,52

590/1 1 005900003

Nm	Kgfm	lbf.in	lbf.ft	A mm	L mm	kg
1÷27	0,1÷2,7	10÷240	3/8	70	253	0,52

592/3 1 005920005

Nm	Kgfm	lbf.in	lbf.ft	A mm	L mm	kg
3÷40	0,3÷4	20÷360	3/8	70	253	0,52

592/4 1 005920007



594

chiavi dinamometriche a lettura diretta
adatte a serraggi destrorsi e sinistrorsi
precisione di serraggio ± 4%

12"



UNI EN 26789
ISO 6789

Nm	Kgfm	lbf.ft	lbf.in	A mm	L mm	kg
6÷80	0,6÷8	5÷60	1/2	85	455	1,35

594/8 1 005940011

Nm	Kgfm	lbf.ft	lbf.in	A mm	L mm	kg
20÷215	2÷21,5	15÷160	1/2	85	530	1,40

594/21 1 005940015

**Servizio di taratura
dinamometrica
a fine listino**

596 - 598

chiavi dinamometriche a lettura diretta
adatte a serraggi destrorsi e sinistrorsi
precisione di serraggio ± 4%

Il raggiungimento della coppia prefissata
viene segnalato da una luce
e da un suono intermittente



UNI EN 26789
ISO 6789

Nm	Kgfm	lbf.ft	lbf.in	A mm	L mm	kg
80÷400	8÷40	60÷300	3/4	111	710	3,2

596/40SL 1 005960010

Nm	Kgfm	lbf.ft	lbf.in	A mm	L mm	kg
160÷800	16÷80	120÷600	3/4	115	1025	4,85

596/80SL 1 005960020

Nm	Kgfm	lbf.ft	lbf.in	A mm	L mm	kg
400÷2000	40÷200	300÷1500	1"	135	1930	16,70

598/200SL 1 005980022

599DGT

chiave dinamometrica elettronica con cricchetto reversibile, per serraggi destrorsi e sinistrorsi
precisione di serraggio +/- 2% destrorso, +/- 3% sinistrorso

il raggiungimento della coppia prefissata viene segnalato da avvisatori luminosi e da un suono intermittente

• Alimentazione con 2 batterie da 1,5V (incluse)



UNI EN 26789
ISO 6789

Nm	Kgfm	lbf.ft	■	D mm	A mm	L mm	kg
12÷60	1,2÷6	8÷44	3/8	30	33	413	0,9

599DGT/6 1 005990003

Nm	Kgfm	lbf.ft	■	D mm	A mm	L mm	kg
20÷100	2÷20	15÷80	1/2	30	37	413	0,9

599DGT/10X 1 005990010

Nm	Kgfm	lbf.ft	■	D mm	A mm	L mm	kg
40÷200	4÷20	30÷150	1/2	40	43	520	2

599DGT/20 1 005990020

Nm	Kgfm	lbf.ft	■	D mm	A mm	L mm	kg
68÷340	6,8÷34	58÷280	1/2	40	43	539	2,35

599DGT/30 1 005990030

599DGT-A

chiave dinamometrica elettronica a lettura di coppia e angolo
con cricchetto reversibile,
per serraggi destrorsi (precisione +/- 2%)
e sinistrorsi (precisione +/- 3%)

- Software interno per la memorizzazione dei dati: possibilità di preregolare fino a 9 valori di coppia/angolo
- Software e cavo USB per scaricare i dati
- Doppia modalità di misura: picco e traccia
- Il raggiungimento della coppia o dell'angolo prefissati vengono segnalati da avvisatori luminosi e da un suono intermittente
- Impugnatura bimatériauale antiscivolo
- Alimentazione: 2 batterie AA - 1,5V incluse



UNI EN 26789
ISO 6789

Nm	Kgfm	lbf.ft	■	D mm	A mm	L mm	kg
20÷100	2÷10	15÷80	1/2	30	33	413	0,9

599DGT-A/10 1 005990510

Nm	Kgfm	lbf.ft	■	D mm	A mm	L mm	kg
40÷200	4÷20	30÷150	1/2	40	43	520	1,3

599DGT-A/20 1 005990520

Servizio di taratura
dinamometrica
a fine listino

600

attrezzi per serraggi angolari

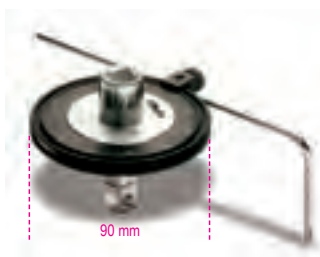

	□	■		
600/1	1/2	1/2	1	006000001
600/2	3/4	3/4	1	006000002

601C

goniometro digitale per serraggi angolari, magnetico
il raggiungimento dell'angolo prefissato viene segnalato da avvisatori luminosi e da un suono intermittente



601C

85x80x87 mm - 70 g

1 006010100

601CA

goniometro digitale per serraggi
coppia ed angolo

il raggiungimento della coppia o dell'angolo prefissati viene segnalato da avvisatori luminosi e da un suono intermittente



601CA 1/2" 1/2" 10÷200

120x90x120 mm - 240 g

1 006010120

603

chiavi dinamometriche a slittamento
per serraggi destrorsi
precisione di serraggio ± 6%



UNI EN 26789
ISO 6789

Nm	Kgfm	lbf.in	■	A mm	L mm	g
1÷5	0,1÷0,5	10÷45	1/4	35	195	235

603/5

1 006030005

Nm	Kgfm	lbf.in	■	A mm	L mm	g
2÷10	0,2÷1,0	18÷90	1/4	35	195	235

603/10

1 006030010

Beta

604B

barre dinamometriche a disinnesto per serraggi destrorsi e sinistrorsi
precisione di serraggio $\pm 6\%$



UNI EN 26789
ISO 6789

Nm	Kgfm	lbf.in	\emptyset mm	L mm	\hat{g} g
1÷5	0,1÷0,5	10÷45	8	220	290

604B/5  1 006040015

Nm	Kgfm	lbf.in	\emptyset mm	L mm	\hat{g} g
2÷10	0,2÷1,0	18÷90	8	220	300

604B/10  1 006040020

605E

chiavi dinamometriche a scatto con cricchetto reversibile per serraggi destrorsi e sinistrorsi
precisione di serraggio $\pm 6\%$



UNI EN 26789
ISO 6789

Nm	Kgfm	lbf.in	\hat{g} mm	A mm	L mm	\hat{g} g
1÷5	0,1÷0,5	10÷45	1/4	20	190	180

605E/5  1 006050105

Nm	Kgfm	lbf.in	\hat{g} mm	A mm	L mm	\hat{g} g
2÷10	0,2÷1,0	18÷90	1/4	20	190	180

605E/10  1 006050110

606/2 - 606/2X

chiavi dinamometriche a scatto con cricchetto reversibile per serraggi destrorsi e sinistrorsi
precisione di serraggio $\pm 4\%$

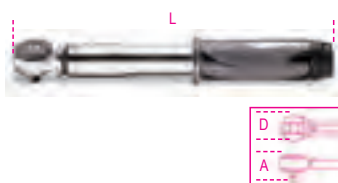

UNI EN 26789
ISO 6789

Nm	Kgfm	lbf.in	\hat{g} mm	D mm	A mm	L mm	\hat{g} g
4÷20	0,4÷2	40÷180	1/4	28	25	220	400

606/2  1 006060102

Nm	Kgfm	lbf.in	\hat{g} mm	D mm	A mm	L mm	\hat{g} g
4÷20	0,4÷2	40÷180	3/8	28	31	220	400

606/2X  1 006060103

606/6 ÷ 606/30

chiavi dinamometriche a scatto con cricchetto reversibile per serraggi destrorsi
precisione di serraggio $\pm 4\%$



UNI EN 26789
ISO 6789

Nm	Kgfm	lbf.ft	\hat{g} mm	D mm	A mm	L mm	\hat{g} g
8÷60	0,8÷6	6÷44	3/8	30	33	305	595

606/6  1 006060105

Nm	Kgfm	lbf.ft	\hat{g} mm	D mm	A mm	L mm	\hat{g} g
20÷100	2÷10	15÷80	3/8	30	33	345	660

606/10  1 006060110

Nm	Kgfm	lbf.ft	\hat{g} mm	D mm	A mm	L mm	\hat{g} g
20÷100	2÷10	15÷80	1/2	30	37	345	680

606/10X  1 006060111

Nm	Kgfm	lbf.ft	\hat{g} mm	D mm	A mm	L mm	\hat{g} g
40÷200	4÷20	30÷150	1/2	40	43	440	920

606/20  1 006060120

Nm	Kgfm	lbf.ft	\hat{g} mm	D mm	A mm	L mm	\hat{g} g
60÷330	6÷33	40÷250	1/2	40	43	560	1180

606/30  1 006060130

608/2

barra dinamometrica a scatto per serraggi destrorsi e sinistrorsi
precisione di serraggio $\pm 4\%$



UNI EN 26789
ISO 6789

Nm	Kgfm	lbf.in	\emptyset mm	L mm	\hat{g} g
4÷20	0,4÷2	40÷180	16	208	330

608/2  1 006080102

611

cricchetti reversibili per barre dinamometriche 604B/5 e 604B/10



\hat{g} mm	L mm	\hat{g} g
1/4	42,5	1 006110001

Servizio di taratura
dinamometria
a fine listino

612 ÷ 614

cricchetti reversibili per barre dinamometriche



Gli articoli 612 e 612X non devono essere utilizzati con coppie di serraggio superiori a 100 Nm

	\hat{g} mm	L mm	\hat{g} g
612	3/8	66	2 006120000
612X	1/2	66	2 006120010
614	1/2	71	2 006140000
614X	3/4	71	2 006140004

614/50

cricchetto semplice per barre dinamometriche



	\hat{g} mm	L mm	\hat{g} g
614/50	1/2	71	2 006140002

Meccanismi rotanti
di ricambio dei cricchetti,
vedi tabella dopo l'art. 929/C8

615

cricchetti reversibili
per barre dinamometriche
con attacco rettangolare



mm	mm	L mm		
9x12	3/8	53	1	006150010
9x12	1/2	53	1	006150020
14x18	1/2	70	1	006150120

616 - 617 - 619

quadri maschi
per barre dinamometriche



	mm	L mm		
616	1/4	61	1	006160000
617	3/8	61	1	006170000
619	1/2	63	1	006190000

621

accessori portainseri
per barre dinamometriche
con attacco rettangolare,
con magneti



	mm	mm	L mm		
621P1/4	9x12	1/4	40	1	006210000
621P5/16	14x18	5/16	61	1	006210110

641

chiavi a forchetta
per barre dinamometriche 604B/5 e 604B/10



mm	L mm		
4	37	1	006410003
5	37	1	006410004
5,5	37	1	006410005
6	37	1	006410006
7	37	1	006410007
8	42	1	006410008
9	42	1	006410009
10	42	1	006410010

642

chiavi a forchetta
per barre dinamometriche



mm	L mm		
8	54	1	006420008
10	57	1	006420010
12	58	1	006420012
13	58	1	006420013
14	59	1	006420014
15	59	1	006420015
16	59	1	006420016
17	60	1	006420017
18	61	1	006420018
19	61	1	006420019
21	62	1	006420021
22	62	1	006420022
24	63	1	006420024
26	64	1	006420026
27	65	1	006420027
30	66	1	006420030
32	67	1	006420032
36	76	1	006420036
41	78	1	006420041
46	90	1	006420046

643

chiavi a forchetta
per barre dinamometriche
con attacco rettangolare



mm	mm	L mm		
8	9x12	37	1	006430008
10	9x12	39	1	006430010
12	9x12	39	1	006430012
13	9x12	39	1	006430013
14	9x12	43	1	006430014
15	9x12	43	1	006430015
16	9x12	43	1	006430016
17	9x12	43	1	006430017
18	9x12	47	1	006430018
19	9x12	51	1	006430019

mm	mm	L mm		
13	14x18	60	1	006430113
14	14x18	58	1	006430114
15	14x18	60	1	006430115
16	14x18	60	1	006430116
17	14x18	60	1	006430117
18	14x18	61	1	006430118
19	14x18	61	1	006430119
21	14x18	61	1	006430121
22	14x18	62	1	006430122
24	14x18	64	1	006430124
27	14x18	68	1	006430127
30	14x18	77	1	006430130
32	14x18	77	1	006430132
34	14x18	80	1	006430134
36	14x18	83	1	006430136

652

chiavi poligonali
per barre dinamometriche



mm	L mm		
8	58	1	006520008
10	58	1	006520010
12	58	1	006520012
13	58	1	006520013
14	58	1	006520014
15	62	1	006520015
16	63	1	006520016
17	64	1	006520017
18	65	1	006520018
19	65	1	006520019
21	67	1	006520021
22	68	1	006520022
24	69	1	006520024
26	71	1	006520026
27	71	1	006520027
30	73	1	006520030
32	74	1	006520032

653

chiavi poligonali
per barre dinamometriche
con attacco rettangolare



mm	mm	L mm		
8	9x12	40	1	006530008
10	9x12	43	1	006530010
12	9x12	44	1	006530012
13	9x12	44	1	006530013
14	9x12	45	1	006530014
15	9x12	46	1	006530015
16	9x12	47	1	006530016
17	9x12	47	1	006530017
18	9x12	48	1	006530018
19	9x12	49	1	006530019
22	9x12	52	1	006530022

mm	mm	L mm		
13	14x18	61	1	006530113
14	14x18	61	1	006530114
15	14x18	62	1	006530115
16	14x18	63	1	006530116
17	14x18	64	1	006530117
18	14x18	65	1	006530118
19	14x18	65	1	006530119
21	14x18	68	1	006530121
22	14x18	68	1	006530122
24	14x18	69	1	006530124
27	14x18	75	1	006530127
30	14x18	78	1	006530130
32	14x18	78	1	006530132
34	14x18	81	1	006530134
36	14x18	83	1	006530136

666N LBF.IN

chiavi dinamometriche a scatto con cricchetto reversibile per serraggi destrorsi precisione di serraggio $\pm 3\%$

• Scala in libbre-forza per pollice



UNI EN 26789
ISO 6789

lbf.in	■	D mm	A mm	L mm	g
90÷440	3/8	30	33	312	660

666N LBF.IN/5 1 006660055

lbf.in	■	D mm	A mm	L mm	g
200÷800	3/8	30	33	381	730

666N LBF.IN/10 1 006660070

lbf.in	■	D mm	A mm	L mm	g
200÷800	1/2	30	37	387	800

666N LBF.IN/10X 1 006660071

lbf.in	■	D mm	A mm	L mm	g
400÷1800	1/2	40	43	470	1010

666N LBF.IN/20 1 006660072

lbf.in	■	D mm	A mm	L mm	g
500÷3000	1/2	40	43	598	1380

666N LBF.IN/30 1 006660073

666N

chiavi dinamometriche a scatto con cricchetto reversibile per serraggi destrorsi precisione di serraggio $\pm 3\%$



UNI EN 26789
ISO 6789

Nm	Kgfm	lbf.ft	■	D mm	A mm	L mm	g
10÷50	1÷5	7÷37	3/8	30	33	312	660

666N/5 1 006660005

Nm	Kgfm	lbf.ft	■	D mm	A mm	L mm	g
20÷100	2÷10	15÷75	3/8	30	33	381	730

666N/10 1 006660010

Nm	Kgfm	lbf.ft	■	D mm	A mm	L mm	g
20÷100	2÷10	15÷75	1/2	30	37	387	800

666N/10X 1 006660011

Nm	Kgfm	lbf.ft	■	D mm	A mm	L mm	g
40÷200	4÷20	30÷150	1/2	40	43	470	1010

666N/20 1 006660020

Nm	Kgfm	lbf.ft	■	D mm	A mm	L mm	g
60÷300	6÷30	50÷220	1/2	40	43	598	1380

666N/30 1 006660030

667N

chiavi dinamometriche a scatto con cricchetto semplice per serraggi destrorsi e sinistrorsi precisione di serraggio $\pm 3\%$



UNI EN 26789
ISO 6789

Nm	Kgfm	lbf.ft	■	D mm	A mm	L mm	g
40÷200	4÷20	30÷150	1/2	40	43	470	1010

667N/20 1 006670020

Nm	Kgfm	lbf.ft	■	D mm	A mm	L mm	g
60÷300	6÷30	50÷220	1/2	40	43	598	1380

667N/30 1 006670030

Nm	Kgfm	lbf.ft	■	D mm	A mm	L mm	g
80÷400	8÷40	60÷295	3/4	50	50	711	2090

667N/40 1 006670040

Meccanismi rotanti di ricambio dei cricchetti, vedi tabella dopo l'art. 929/C8

668N

barre dinamometriche a scatto per serraggi destrorsi e sinistrorsi precisione di serraggio $\pm 3\%$



UNI EN 26789
ISO 6789

Nm	Kgfm	lbf.ft	Ø mm	L mm	g
10÷50	1÷5	7÷37	16	307	590

668N/5 1 006680005

Nm	Kgfm	lbf.ft	Ø mm	L mm	g
20÷100	2÷10	15÷75	16	376	670

668N/10 1 006680010

Nm	Kgfm	lbf.ft	Ø mm	L mm	g
40÷200	4÷20	30÷150	16	450	795

668N/20 1 006680020

Nm	Kgfm	lbf.ft	Ø mm	L mm	g
60÷300	6÷30	50÷220	16	588	1230

668N/30 1 006680030

Beta

668RG

barra dinamometrica a scatto,
non graduata
adatta a serraggi destrorsi e sinistrorsi
precisione di serraggio $\pm 4\%$
(per il settaggio della coppia usare gli art.
680/40 - 682)



UNI EN 26789
ISO 6789

Nm	Kgfm	lbf.ft	Ø mm	L mm	g
8÷60	0,8÷6	6÷44	16	288	550

668RG/6 1 006680206

Nm	Kgfm	lbf.ft	Ø mm	L mm	g
20÷100	2÷10	15÷80	16	315	600

668RG/10 1 006680210

Nm	Kgfm	lbf.ft	Ø mm	L mm	g
40÷200	4÷20	30÷150	16	405	780

668RG/20 1 006680220

Nm	Kgfm	lbf.ft	Ø mm	L mm	g
60÷300	6÷30	50÷220	16	645	1130

668RG/30 1 006680230

669N

barre dinamometriche a scatto,
attacco rettangolare
per serraggi destrorsi e sinistrorsi
precisione di serraggio $\pm 3\%$



UNI EN 26789
ISO 6789

Nm	Kgfm	lbf.ft	Ø mm	L mm	g
10÷50	1÷5	7÷37	9x12	307	590

669N/5 1 006690205

Nm	Kgfm	lbf.ft	Ø mm	L mm	g
20÷100	2÷10	15÷75	9x12	376	670

669N/10 1 006690210

Nm	Kgfm	lbf.ft	Ø mm	L mm	g
40÷200	4÷20	30÷150	9x12	450	795

669N/20 1 006690220

Nm	Kgfm	lbf.ft	Ø mm	L mm	g
40÷200	4÷20	30÷150	14x18	450	795

669N/20X 1 006690221

Nm	Kgfm	lbf.ft	Ø mm	L mm	g
60÷300	6÷30	50÷220	14x18	588	1230

669N/30 1 006690230

671B/C5

barra dinamometrica 604B/5 e accessori



671B/C5 1 006710001

604B/5	1÷5 Nm
611	1/4
641	5-6-7-8 mm
900	4-5-5,5-6-7-8-9-10 mm

270x120x45 mm - 1,3 kg

671B/C10

barra dinamometrica 604B/10 e accessori



671B/C10 1 006710002

604B/10	2÷10 Nm
611	1/4
641	6-7-8-10 mm
900	4-5-5,5-6-7-8-9-10 mm

270x120x45 mm - 1,4 kg

671N/C10

barra dinamometrica 668N/10
e accessori



671N/C10 1 006710110

668N/10	100 Nm
612	3/8
617	3/8
642	10-13-14-17-19 mm
652	10-13-14-17-19 mm
910A	3/8 8-10-11-13-14-17-19 mm
910/21	125 mm
910/22	250 mm

400x180x45 mm - 4,3 kg

671N/C20

barra dinamometrica 668N/20
e accessori



671N/C20 1 006710120

668N/20	200 Nm
614	1/2
619	1/2
642	10-13-14-17-19 mm
652	10-13-14-17-19 mm
920A	1/2 10-11-13-14-17-19-22 mm
920/20	75 mm
920/21	125 mm
920/22	255 mm

510x180x45 mm - 5,5 kg

671N/C30

barra dinamometrica 668N/30
e accessori



671N/C30 1 006710130

668N/30	300 Nm
614	1/2
619	1/2
642	13-14-17-19 mm
652	13-14-17-19 mm
920A	1/2 13-14-17-19-22-24-27 mm
920/20	75 mm
920/21	125 mm
920/22	255 mm

620x180x45 mm - 5,8 kg

677

chiavi dinamometriche a disinnesto con cricchetto semplice per serraggi destrorsi e sinistrorsi precisione di serraggio $\pm 4\%$

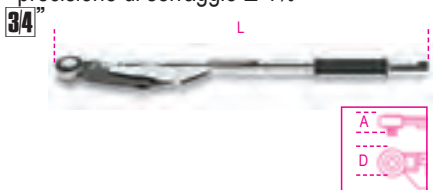

UNI EN 26789
ISO 6789

Nm	Kgfm	lbf.ft	D mm	A mm	L mm	kg
100÷500	10÷50	70÷350	70	55	915	5,2

677/50 1 006770050

Nm	Kgfm	lbf.ft	D mm	A mm	L mm	kg
150÷700	15÷70	100÷500	70	55	1140	6,2

677/70 1 006770070

Nm	Kgfm	lbf.ft	D mm	A mm	L mm	kg
300÷1000	30÷100	200÷750	70	55	1470	7,5

677/100 1 006770100

677/C

chiavi dinamometriche a disinnesto con cricchetto semplice per serraggi destrorsi e sinistrorsi precisione di serraggio $\pm 4\%$ in cassetta



UNI EN 26789
ISO 6789

Nm	Kgfm	lbf.ft	D mm	A mm	L mm	kg
100÷500	10÷50	70÷350	70	55	915	5,2

677/C50 1 006770606

Nm	Kgfm	lbf.ft	D mm	A mm	L mm	kg
150÷700	15÷70	100÷500	70	55	1140	6,2

677/C70 1 006770611

Nm	Kgfm	lbf.ft	D mm	A mm	L mm	kg
300÷1000	30÷100	200÷750	70	55	1470	7,5

677/C100 1 006770615

Nm	Kgfm	lbf.ft	D mm	A mm	L mm	kg
700÷1500	70÷150	500÷1000	70	70	1475	10,4

677/C150 1 006770620

677/CP200

chiavi dinamometriche a disinnesto con cricchetto semplice per serraggi destrorsi e sinistrorsi precisione di serraggio $\pm 4\%$ in cassetta



UNI EN 26789
ISO 6789

Nm	Kgfm	lbf.in	D mm	A mm	L mm	kg
900÷2000	90÷200	600÷1500	70	63	1920	13

677/CP200 1 006770720

Servizio di taratura
dinamometria
a fine listino

678/C

chiavi dinamometriche a scatto con cricchetto semplice per serraggi destrorsi e sinistrorsi precisione di serraggio $\pm 4\%$ in cassetta

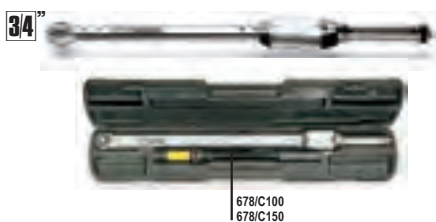

Nm	Kgfm	lbf.ft	D mm	A mm	L mm	kg
110÷550	11÷55	80÷405	61	55	845	3,7

678/C55 1 006780606

Nm	Kgfm	lbf.ft	D mm	A mm	L mm	kg
300÷1000	30÷100	220÷750	75	60	1250	6,0

678/C100 1 006780611

Nm	Kgfm	lbf.ft	D mm	A mm	L mm	kg
500÷1500	50÷150	370÷1100	75	60	1570	8,5

678/C150 1 006780615

677/CV - 678/CV

cassette vuote per chiavi dinamometriche 677 e 678



677/CV1 1 006770450

677/C50-677/C70

678/CV1 1 006780455

678/C55

678/CV2 1 006780500

678/C100

678/CV3 1 006780415

677/C100-677/C150-678/C150

680

misuratore di coppia elettronico digitale Dynatester 680 per verifica tarature funzionamento destrorso e sinistrorso

Precisione di lettura: $\pm 1\%$ del valore letto



	Nm	kg	
680/2,5	1÷25	2,6	1 006800002
680/40	15÷400	4	1 006800040
680/100	100÷1000	4,8	1 006800100

Beta

Beta

682

misuratore di coppia elettronico digitale con trasduttori porziometrici
Dynatester 682
funzionamento destrorso e sinistrorso

Alta precisione di lettura
Fornito di uscita seriale RS 232



CE

CARATTERISTICHE TECNICHE:

Precisione di lettura: $\pm 1\%$ del valore letto
Unità di misura selezionabili
Nm-dNm-cNm-Lbf.ft-Lbf.in-Ozf.in-Kgf.m-Kgf.cm-gf.cm
Alimentazione: 90 a 264V AC a 50/60 Hz
Dimensioni: 235x185x185 mm
Verifica di tolleranza secondo norma ISO6789
Indicazione dell'intervallo di accettabilità specifico per ogni chiave dinamometrica testata
Display: Menu selezionabile in 11 lingue
Documentazione allegata
Certificato di calibrazione con rintracciabilità UKAS

	Nm	kg		
682/60	1,2±60	5,9	1	006820006
682/400	8±400	6,1	1	006820040
682/1500	30±1500	6,4	1	006820150

710

chiavi a bussola Macchina serie normale



UNI/ISO 2725 DIN 3129

mm	Ø mm	L mm	Ø1 mm		
7	12,5	28	19	3	007100007
8	13,8	28	19	3	007100008
9	15,0	28	19	3	007100009
10	16,3	28	19	3	007100010
11	17,5	30	19	3	007100011
12	19,0	30	19	3	007100012
13	20,0	30	22	3	007100013
14	21,3	30	22	3	007100014
16	23,8	30	22	3	007100016
17	25,0	30	22	3	007100017
18	26,3	30	22	3	007100018
19	27,5	30	22	3	007100019
21	30,0	32	22	3	007100021
22	32,0	32	22	3	007100022

710/16

raccordo Macchina con attacco quadro femmina 3/8" e maschio 1/2"



L mm	Ø mm				
32	22	3/8	1/2	3	007100810

710/20

prolunga Macchina con attacchi quadri maschio e femmina 3/8"



L mm	Ø mm				
75	22			2	007100821

710/21

prolunga Macchina con attacchi quadri maschio e femmina 3/8"



L mm	Ø mm				
125	22			2	007100823

710/25

snodo Macchina con attacchi quadri maschio e femmina 3/8"



L mm	Ø mm				
58	24			2	007100830

710/C10

10 chiavi a bussola Macchina



710/C10			
7-8-10-11-12-13	1	007100910	
14-17-19-22 mm			

130x55x40 mm - 800 g

710/OR... - 710/SP...

anelli e spine per bussole e accessori Macchina



	710 mm	710/16 L mm		
710/OR1	7÷12		10	007100921
710/OR2	13÷22	32	10	007100922
710/SP1	7÷12		10	007100911
710/SP2	13÷22	32	10	007100912

720

chiavi a bussola Macchina serie normale



UNI/ISO 2725 DIN 3129

mm	Ø mm	L mm	Ø1 mm		
10	17,0	38	25	5	007200010
11	18,5	38	25	5	007200011
12	20,0	38	25	5	007200012
13	21,0	38	25	5	007200013
14	22,5	38	25	5	007200014
15	23,0	38	30	5	007200015
16	25,0	38	30	5	007200016
17	26,0	38	30	5	007200017
18	27,5	38	30	5	007200018
19	28,5	38	30	5	007200019
21	31,0	38	30	5	007200021
22	32,5	38	30	5	007200022
23	34,0	38	30	5	007200023
24	35,0	38	30	5	007200024
27	38,5	45	30	3	007200027
30	42,0	50	30	3	007200030
32	44,0	50	30	3	007200032
36	50,0	50	30	3	007200036

720AS

chiavi a bussola Macchina serie normale



"	Ø mm	L mm	Ø1 mm		
3/8	17,0	38	25	2	007200210
7/16	18,2	38	25	2	007200211
1/2	20,7	38	25	2	007200213
9/16	22,0	38	25	2	007200214
5/8	24,5	38	30	2	007200216
11/16	25,7	38	30	2	007200217
3/4	28,2	38	30	2	007200219
13/16	30,7	38	30	2	007200221
7/8	32,0	38	30	2	007200222
15/16	34,5	38	30	2	007200224
1	35,7	38	30	2	007200225
1.1/16	38,2	40	30	1	007200227
1.1/8	40,7	42	30	1	007200229
1.1/4	44,5	42	30	1	007200232

720L

chiavi a bussola Macchina serie lunga



UNI/ISO 2725

"	Ø mm	L mm	Ø1 mm		
10	17,0	80	25	2	007200310
11	18,5	80	25	2	007200311
12	20,0	80	25	2	007200312
13	21,0	80	25	2	007200313
14	22,5	80	25	2	007200314
15	23,0	80	30	2	007200315
16	25,0	80	30	2	007200316
17	26,0	80	30	2	007200317
18	27,5	80	30	2	007200318
19	28,5	80	30	2	007200319
21	31,0	80	30	2	007200321
22	32,5	80	30	2	007200322
24	35,0	80	30	2	007200324
27	38,5	80	30	2	007200327
30	42,0	80	30	2	007200330
32	44,0	80	30	2	007200332
36	50,0	80	30	2	007200336

720L/S3

serie di 3 chiavi a bussola 720L



mm		
17-19-21	1	007200355

720LS

chiavi a bussola Macchina serie lunga sottile



UNI/ISO 2725

"	Ø mm	L mm	Ø1 mm		
10	15,5	78	24	2	007200360
11	16,7	78	24	2	007200361
12	18,0	78	24	2	007200362
13	19,2	78	24	2	007200363
14	20,5	78	24	2	007200364
15	21,7	78	24	2	007200365
16	23,0	78	24	2	007200366
17	24,2	78	29	2	007200367
18	25,5	78	29	2	007200368
19	26,7	78	29	2	007200369
21	29,2	78	29	2	007200371
22	30,5	78	29	2	007200372
24	33,0	78	29	2	007200374
27	36,7	78	29	2	007200377
30	40,5	78	29	2	007200380
32	43,0	78	29	2	007200382
36	48,0	78	29	2	007200386

720LC

chiavi a bussola Macchina per dadi ruote con inserti polimerici colorati



"	D mm		
17	24,8		2 007200637
19	26,8		2 007200639
21	28,6		2 007200641
22	30,7		2 007200642
24	32,9		2 007200644



720LC/C3 1 007200653

148x132x44 mm - 860 g



720LC/S5 1 007200645

17-19-21-22-24 mm

720IC

inserti di ricambio polimerici colorati per chiavi a bussola 720LC



"	mm		
720IC17	17		1 007200687
720IC19	19		1 007200689
720IC21	21		1 007200691
720IC22	22		1 007200692
720IC24	24		1 007200694

720MRC

chiave a bussola Macchina con inserto polimerico per vite ruota con profilo Mercedes



"	D mm	L mm		
19	27	85	1/2	1 007200631

720FTX

chiavi a bussola Macchina per viti con testa a profilo Torx®



"	Ø mm	L mm	Ø1 mm		
E10	14,0	38	25	2	007200410
E12	15,9	38	25	2	007200412
E14	17,7	38	25	2	007200414
E16	20,0	38	25	2	007200416
E18	22,0	38	25	2	007200418
E20	25,0	40	25	2	007200420



720FTX/SB6 1 007200450

E10-E12-E14
E16-E18-E20

720TX

chiavi a bussola maschio Macchina per viti con impronta Torx®



"	Ø mm	L mm	L1 mm		
T30	25	78	54	3	007200460
T40	25	78	54	3	007200470
T45	25	78	54	3	007200472
T50	25	78	54	3	007200474
T55	25	78	54	3	007200476
T60	25	78	54	3	007200478

Beta

720TX/C6

6 chiavi a bussola macchina per viti con impronta Torx®



720TX/C6
T30-T40-T45
T50-T55-T60

1 007200483

275x120x65 mm - 5700 g

720ME

chiavi a bussola macchina maschio esagonale

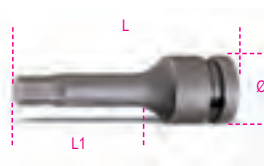

mm	Ø mm	L mm	L1 mm	
5	25	78	54	3 007200505
6	25	78	54	3 007200506
8	25	78	54	3 007200508
10	25	78	54	3 007200510
12	25	78	54	3 007200512
14	25	78	54	3 007200514
17	25	78	54	3 007200517
19	25	78	54	3 007200519

720ME/C8

8 chiavi a bussola macchina maschio esagonale



720ME/C8
5-6-8-10-12
14-17-19 mm

1 007200525

270x120x45 mm - 1710 g

720/15

raccordo macchina con attacco quadro femmina 1/2" e maschio 3/8"

12"



L mm	Ø mm	□	■	
37,5	25	1/2	3/8	3 007200810



E' assolutamente necessario commisurare la coppia di serraggio alla capacità del quadro maschio per evitare rotture o danni accidentali

720/16

raccordo macchina con attacco quadro femmina 1/2" e maschio 3/4"

12"



L mm	Ø mm	□	■	
44	30	1/2	3/4	3 007200814

720/20

prolunga macchina con attacchi quadri maschio e femmina 1/2"

12"



L mm	Ø mm			
75	25	3	007200818	

720/21

prolunga macchina con attacchi quadri maschio e femmina 1/2"

12"



L mm	Ø mm			
125	25	3	007200822	

720/25

snodo macchina con attacchi quadri maschio e femmina 1/2"

12"



L mm	Ø mm			
64	28	2	007200831	

720/C6

6 chiavi a bussola macchina

12"



720/C6
13-14-17-19-22-24 mm

1 007200910

195x80x55 mm - 1100 g

720/C12

12 chiavi a bussola macchina

12"



720/C12
10-11-12-13-14-17
19-22-24-27-30-32 mm

1 007200912

195x80x55 mm - 2000 g

720TC

barre di torsione macchina colorate per dadi ruote autoveicoli con attacchi quadri maschio e femmina 1/2"

12"



Nm	L mm			
90	200		1	007200769
100	200		1	007200770
110	200		1	007200771
120	200		1	007200772
135	200		1	007200773

12"



720TC/S5
90-100-110-120-135 Nm

1 007200779

260x50x175 mm - 1,35 kg



720/OR... - 720/SP...

anelli e spine per bussole e accessori
Macchina

12"

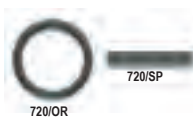

	720 mm	720TX mm		
720/OR1	10÷14	T30÷T60	10	007200923
720/OR2	15÷32		10	007200924
720/SP1	10÷14	T30÷T60	10	007200913
720/SP2	15÷32		10	007200914

727PI/16

bussola portainseri Macchina
per 727/ES16 e 727/ES16TX

3/4"



Ø mm	L mm	Ø mm	□ 3/4	
44	52	16	3/4	2 007270016

727/ES16

inserti Macchina maschio esagonale,
attacco 16 mm

1"



mm	mm	L mm	
10	16	40	2 007270110
12	16	40	2 007270112
13	16	40	2 007270113
14	16	40	2 007270114
16	16	40	2 007270116
17	16	40	2 007270117
18	16	40	2 007270118
19	16	40	2 007270119
22	16	40	2 007270122

727/ES16TX

inserti Macchina maschio per viti
con impronta Torx®, attacco 16 mm

1"



	mm	L mm	
T55	16	50	2 007270355
T60	16	50	2 007270360
T70	16	50	2 007270370

727PI/22

bussola portainseri Macchina
per 727/ES22 e 727/ES22TX

1"



Ø mm	L mm	Ø mm	
54	70	22	2 007270022

727/ES22

inserti Macchina maschio esagonale,
attacco 22 mm

1"



mm	mm	L mm	
19	22	50	2 007270219
22	22	50	2 007270222
24	22	50	2 007270224
27	22	50	2 007270227
30	22	50	2 007270230
32	22	50	2 007270232

727/ES22TX

inserti Macchina maschio per viti
con impronta Torx®, attacco 22 mm

1"



	mm	L mm	
T80	22	60	2 007270480
T90	22	60	2 007270490
T100	22	60	2 007270500

727/C16

12 inserti Macchina maschio
e 4 accessori

1"



1"

727/C16 1 007270900

727PI/16

727/ES16 14-17-19 mm

727/ES16TX T55-T60-T70

727PI/22

727/ES22 22-24-27 mm

727/ES22TX T80-T90-T100

96BPC 3-4 mm

335x145x60 mm - 3,6 kg

727PI/32

bussola portainseri Macchina
per 727/ES32

1 1/2"



Ø mm	L mm	Ø mm	
86	66	32	1 007270032

727/ES32

inserti Macchina maschio esagonale,
attacco 32 mm

1 1/2"



mm	mm	L mm	
19	32	44	2 007270519
22	32	44	2 007270522
24	32	44	2 007270524
27	32	44	2 007270527
30	32	44	2 007270530
32	32	44	2 007270532
36	32	44	2 007270536

728

chiavi a bussola Macchina
serie normale

3/4"



UNI/ISO 2725 DIN 3129

mm	Ø mm	L mm	Ø1 mm	
17	30,0	51	44	2 007280017
18	31,0	51	44	2 007280018
19	32,5	51	44	2 007280019
21	35,0	51	44	2 007280021
22	36,0	51	44	2 007280022
23	37,5	51	44	2 007280023
24	38,5	51	44	2 007280024
27	42,5	53	44	2 007280027
28	44,0	53	44	2 007280028
30	46,0	53	44	2 007280030
32	48,5	57	44	2 007280032
33	50,0	57	44	2 007280033
34	51,0	57	44	2 007280034
35	52,5	57	44	2 007280035
36	53,5	57	44	2 007280036
38	56,0	57	44	1 007280038
40	58,5	58	44	1 007280040
41	60,0	58	44	1 007280041
44	64,0	62	44	1 007280044
45	65,0	62	44	1 007280045
46	66,0	62	44	1 007280046
50	71,0	68	54	1 007280050
55	77,5	71	54	1 007280055
60	83,0	73	54	1 007280060
65	88,0	78	54	1 007280065

728FTX

chiavi a bussola Macchina
per viti con testa a profilo Torx®

3/4"



	Ø mm	L mm	Ø1 mm	
E20	28,5	50	44	2 007280420
E22	30,0	50	44	2 007280422
E24	32,5	50	44	2 007280424



728L

chiavi a bussola Macchina serie lunga



mm	Ø	L	Ø1		
19	32,5	90	44	2	007280319
21	35,0	90	44	2	007280321
22	36,0	90	44	2	007280322
24	38,5	90	44	2	007280324
26	41,0	90	44	2	007280326
27	42,5	90	44	2	007280327
30	46,0	90	44	2	007280330
32	48,5	90	44	2	007280332
33	50,0	90	44	1	007280333
34	51,0	90	44	1	007280334
36	53,5	90	44	1	007280336
38	56,0	90	44	1	007280338
41	60,0	90	44	1	007280341
46	66,0	90	44	1	007280346
50	71,0	90	44	1	007280350
55	77,5	100	54	1	007280355

728LS

chiavi a bussola Macchina serie lunga sottile



mm	Ø	L	Ø1		
17	28,0	100	43	2	007280517
19	30,5	100	43	2	007280519
22	34,3	100	43	2	007280522
24	36,8	100	43	2	007280524
27	40,5	100	43	2	007280527
30	44,3	100	43	2	007280530
32	46,8	100	43	2	007280532
33	48,0	100	43	2	007280533
36	51,8	100	43	1	007280536

728LQ

chiavi a bussola Macchina serie lunga (per dadi ruote ISUZU)



mm	L	Ø	Ø1		
19	90	35	43,5	1	007280619
21	90	42	43,5	1	007280621

728/15

raccordo Macchina con attacco quadro femmina 3/4" e maschio 1/2"



mm	Ø	□	■		
58	38	3/4	1/2	2	007280810

728/16

raccordo Macchina con attacco quadro femmina 3/4" e maschio 1"



mm	Ø	□	■		
62	44	3/4	1	2	007280813

728/21

prolunga Macchina con attacchi quadri maschio e femmina 3/4"



mm	Ø				
175	44			2	007280815

728/22

prolunga Macchina con attacchi quadri maschio e femmina 3/4"



mm	Ø				
250	44			2	007280825

728/22L

prolunga Macchina con attacchi quadri maschio e femmina 3/4"



mm	Ø				
330	44			1	007280826

728/25

snodo Macchina con attacchi quadri maschio e femmina 3/4"



mm	Ø				
107,5	44			1	007280830

728/C10

10 chiavi a bussola Macchina



728/C10			1 007280910
17-19-22-24-27-30			
32-36-41-46 mm			

275x120x65 mm - 5,7 kg

728/OR - 728/SP

anelli e spine per bussole e accessori Macchina



mm	Ø				
728/OR	728/15			5	007280925
728/OR	17÷46	E20÷E24		10	007280926
728/SP	17÷46	E20÷E24		10	007280916

729

chiavi a bussola Macchina serie normale



UNI/ISO 2725 DIN 3129

mm	Ø	L	Ø1		
24	41,5	58	54	1	007290024
27	45,0	60	54	1	007290027
30	49,0	62	54	1	007290030
32	51,5	63	54	1	007290032
33	52,5	63	54	1	007290033
34	54,0	63	54	1	007290034
36	56,5	66	54	1	007290036
38	59,0	66	54	1	007290038
41	62,5	68	54	1	007290041
46	69,0	72	54	1	007290046
50	74,0	76	54	1	007290050
55	80,0	84	54	1	007290055
60	86,5	88	54	1	007290060
65	92,5	92	54	1	007290065
70	99,0	96	54	1	007290070
75	105,0	102	63	1	007290075
80	111,5	102	63	1	007290080

729L

chiavi a bussola Macchina serie lunga



mm	Ø	L	Ø1		
24	41,5	108	54	1	007290324
27	45,0	108	54	1	007290327
30	49,0	108	54	1	007290330
32	51,5	108	54	1	007290332
33	52,2	108	54	1	007290333



E' assolutamente necessario commisurare la coppia di serraggio alla capacità del quadro maschio per evitare rotture o danni accidentali

Beta

Ø mm	Ø mm	L mm	Ø1 mm		
34	54,0	108	54	1	007290334
36	56,5	108	54	1	007290336
41	62,5	108	54	1	007290341
46	69,0	108	54	1	007290346
50	74,0	108	54	1	007290350
55	80,0	108	54	1	007290355
60	86,5	108	54	1	007290360
65	92,5	108	54	1	007290365
70	99,0	108	54	1	007290370
75	105,0	108	63	1	007290375
80	111,5	108	63	1	007290380

729LS

chiavi a bussola Macchina serie lunga sottile



Ø mm	Ø mm	L mm	Ø1 mm		
22	36,0	108	53	1	007290522
24	38,5	108	53	1	007290524
27	42,3	108	53	1	007290527
30	46,0	108	53	1	007290530
32	48,5	108	53	1	007290532
33	49,8	108	53	1	007290533
36	53,5	108	53	1	007290536

729T

barre di torsione Macchina per dadi ruote



Ø mm	Nm	L mm		
24	350	300	1	007290724
27	450	300	1	007290757
30	500	300	1	007290730
32	450	300	1	007290732
32	600	300	1	007290762
33	600	300	1	007290763
36	600	300	1	007290736

729/15

raccordo Macchina con attacco quadro femmina 1" e maschio 3/4"



L mm	Ø mm	□	■		
66,5	54	1	3/4	1	007290810



E' assolutamente necessario commisurare la coppia di serraggio alla capacità del quadro maschio per evitare rotture o danni accidentali

729/16

raccordo Macchina con attacco quadro femmina 1" e maschio 1.1/2"



L mm	Ø mm	□	■		
88	54,0	1	1.1/2	1	007290813

729/21

prolunga Macchina con attacchi quadri maschio e femmina 1"



L mm	Ø mm		
175	54	1	007290815

729/22

prolunga Macchina con attacchi quadri maschio e femmina 1"



L mm	Ø mm		
330	54	1	007290825

729/25

snodo Macchina con attacchi quadri maschio e femmina 1"



L mm	Ø mm		
130	54	1	007290830

729/OR... - 729/SP...

anelli e spine per bussole e accessori Macchina



	728 Ø mm	729-730 Ø mm		
729/OR1	50÷60	24÷70	5	007290927
729/OR2		75÷125	5	007290928
729/SP1	50÷60	24÷70	5	007290917
729/SP2		75÷125	5	007290918

730

chiavi a bussola Macchina serie normale



UNI/ISO 2725 DIN 3129	Ø mm	L mm	Ø1 mm		
50	81	87	84	1	007300050
55	88	90	86	1	007300055
60	94	95	86	1	007300060
65	100	100	86	1	007300065
70	106	105	86	1	007300070
75	113	110	86	1	007300075
80	119	115	86	1	007300080
85	125	120	86	1	007300085
90	132	125	86	1	007300090

Ø mm	Ø mm	L mm	Ø1 mm		
95	138	125	96	1	007300095
100	144	130	96	1	007300100
105	150	135	96	1	007300105
110	157	140	96	1	007300110
115	163	140	96	1	007300115
120	169	145	96	1	007300120
125	175	145	96	1	007300125

730/15

raccordo Macchina riduttore



L mm	Ø mm	□	■		
105	84,0	1.1/2	1	1	007300810



E' assolutamente necessario commisurare la coppia di serraggio alla capacità del quadro maschio per evitare rotture o danni accidentali

733/15

raccordo Macchina riduttore



L mm	Ø mm	□	■		
156	127	2.1/2	1.1/2	1	007330810

851

portainseri magnetico con impugnatura



L1 mm	L mm		
45	165	2	008510165
125	245	2	008510245

851SR

portainseri a sgancio rapido con impugnatura



L mm	L1 mm		
230	110	2	008510001

855P

Giravite portainseri a cricchetto reversibile con impugnatura snodata
7 inserti integrati



L mm	L1 mm	n.	Art.
240	100	1	008550010

	860PH	PH1 - PH2
	860PZ	PZ1 - PZ2
	860LP	LP 0,8x5,5 mm
	860PE	4 - 5 mm

860LP

inserti colorati per avvitatori per viti a testa con intaglio

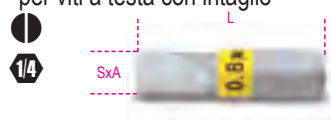

SxA mm	L mm	n.	Art.
0,5x3	25	5	008600005
0,6x4,5	25	5	008600010
0,8x5,5	25	5	008600015
1x5,5	25	5	008600020
1,2x6,5	25	5	008600025

860PH

inserti colorati per avvitatori per viti con impronta a croce Phillips®



PH	L mm	n.	Art.
0	25	5	008600220
1	25	5	008600225
2	25	5	008600230
3	25	5	008600245
4	25	5	008600250

860PZ

inserti colorati per avvitatori per viti con impronta a croce Pozidriv® - Supadriv®

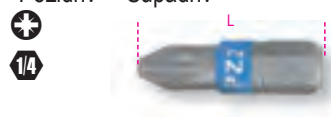

PZ	L mm	n.	Art.
1	25	5	008600320
2	25	5	008600325
3	25	5	008600330
4	25	5	008600335

860PE

inserti colorati maschio esagonale per avvitatori



mm	L mm	n.	Art.
2	25	5	008600101
2,5	25	5	008600102
3	25	5	008600103
4	25	5	008600104
5	25	5	008600105
6	25	5	008600106
8	25	5	008600108
10	25	5	008600110

860TX

inserti colorati per avvitatori per viti con impronta Torx®



T	L mm	n.	Art.
T6	25	5	008600704
T7	25	5	008600705
T8	25	5	008600710
T9	25	5	008600715
T10	25	5	008600720
T15	25	5	008600725
T20	25	5	008600730
T25	25	5	008600735
T27	25	5	008600740
T30	25	5	008600745
T40	25	5	008600750

860RTX

inserti colorati per avvitatori per viti con impronta Tamper Resistant Torx®



T	L mm	n.	Art.
T9	25	5	008600550
T10	25	5	008600555
T15	25	5	008600560
T20	25	5	008600565
T25	25	5	008600570
T27	25	5	008600575
T30	25	5	008600580
T40	25	5	008600585

860/55

cricchetto reversibile portainseri



L mm	Ø	n.	Art.
100	1/4"	3	008600870

860/58

cricchetto portainseri con impugnatura rotante

- L'inserto si può inserire su entrambi i lati per avvitare o svitare
- Impugnatura bimateriale



860/58	L mm	Ø	n.	Art.
	126	1/4"	1	008600884

860/C27

25 inserti per avvitatori, 1 raccordo e 1 cricchetto reversibile in astuccio tascabile



860/C27	n.	Art.
	1	008600880

	860/55	100 mm
	860LP	0,5x3-1,0x5,5-1,2x6,5 mm
	860PH	PH1-PH2(x2)-PH3
	860PZ	PZ1-PZ2(x2)-PZ3
	860PE	2-2,5-3-4-5-6 mm
	860TX	T6-T8-T10-T15-T20-T25-T30-T40
	892/0	● 1/4 ■ 1/4

860PHZ/A10

10 inserti con portainseri magnetico in astuccio tascabile



860PHZ/A10	n.	Art.
	1	008600910

	860PH	PH1	1
		PH2	3
		PH3	1
	860PZ	PZ1	1
		PZ2	3
		PZ3	1
	882M1	○ 1/4 ● 1/4	1

860PHZ/A31

30 inserti con portainseri magnetico a sgancio rapido in astuccio tascabile



860PHZ/A31

1 008600912

	860PH	PH1 PH2 PH3	n. 3 9 3
	860PZ	PZ1 PZ2 PZ3	3 9 3
	882MSR/50	○ 1/4 ● 1/4	

860PE/A10

10 inserti con portainseri magnetico in astuccio tascabile



860PE/A10

1 008600920

	860PE	2 - 2,5 mm 3 - 4 - 5 - 6 mm	n. 1 2
	882M1	○ 1/4 ● 1/4	

860TX/A10

10 inserti con portainseri magnetico in astuccio tascabile



860TX/A10

1 008600970

	860TX	T7 - T8 - T9 - T10 - T15 - T20 T25 - T27 - T30 - T40	n. 1
	882M1	○ 1/4 ● 1/4	

860TX/A31

30 inserti con portainseri magnetico a sgancio rapido in astuccio tascabile



860TX/A31

1 008600972

	860TX	T6 - T7 - T8 T9 - T10 - T15 - T20 - T25 T27 - T30 - T40	n. 2 3
	882MSR/50	○ 1/4 ● 1/4	

860PHT/A31

30 inserti con portainseri magnetico a sgancio rapido in astuccio tascabile



860PHT/A31

1 008600940

	860PH	PH1 PH2	n. 3 6
	860TX	T10 - T15 - T20 - T25 - T27 - T30 - T40	3
	882MSR/50	○ 1/4 ● 1/4	

860RTX/A10

10 inserti con portainseri magnetico in astuccio tascabile



860RTX/A10

1 008600930

	860RTX	T9-T10-T15-T20-T25-T27 T30-T40	n. 1 2
	882M1	○ 1/4 ● 1/4	

860MIX/A10

10 inserti con portainseri magnetico in astuccio tascabile



860MIX/A10

1 008600900

	860LP	0,5x3 - 1x5,5 - 1,2x6,5 mm	n. 1
	860PH	PH1 PH2 PH3	1 2 1
	860PZ	PZ1 - PZ2 - PZ3	1
	882M1	○ 1/4 ● 1/4	

860MIX/A31

30 inserti con portainseri magnetico a sgancio rapido in astuccio tascabile



860MIX/A31

1 008600902

	860LP	0,5x3 - 0,6x4 - 0,8x5,5 1,0x5,5 - 1,2x6,5 mm	n. 1
	860PE	2 - 2,5 - 3 - 4 - 5 - 6 8 - 10 mm	1
	860PH	PH0 - PH1 - PH2 - PH3 - PH4	
	860PZ	PZ1 - PZ2 - PZ3 - PZ4	
	860RTX	T9 - T10 - T15 - T20 T25 - T27 - T30 - T40	
	882MSR/50	○ 1/4 ● 1/4	

860/C38P

1 portainseri con impugnatura a criccheto reversibile, 27 inserti per avvitatori, 8 bussole esagonali e 2 accessori



860/C38P 1 008600878

	860LP	0,6x4,5 - 0,8x5,5 - 1,0x5,5 - 1,2x6,5 mm
	860PE	2-2,5-3-4(x2)-5(x2)
	860PH	PH1(x2)-PH2(x2)-PH3
	860PZ	PZ1(x2)-PZ2(x2)-PZ3
	860TX	T10-T15-T20-T25-T30-T40
	900	5-5,5-6-7-8-9-10-13 mm
	892/0	● 1/4 ■ 1/4
	892/3	● 1/4 ■ 1/4
	855P	240 mm

270x120x45 mm

861LP

inserti per avvitatori per viti a testa con intaglio



ISO 2351-1

ISO 1173 C 6,3

SxA mm	L mm		
0,5x3	25	10	008610005
0,6x4	25	10	008610007
0,6x4,5	25	10	008610010
0,8x5,5	25	10	008610015
1x5,5	25	10	008610020
1,2x6,5	25	10	008610025
1,2x8	25	10	008610028
1,6x8	25	10	008610030

861PH

inserti per avvitatori per viti con impronta a croce Phillips®



ISO 2351-2

ISO 1173 C 6,3

PH	L mm		
0	25	10	008610200
1	25	10	008610205
2	25	10	008610210
2L	50	10	008610213
3	25	10	008610215
4	25	10	008610220

861PH/C

inserti per avvitatori per viti con impronta a croce Phillips®



ISO 2351-2
ISO 1173 C 6,3

PH	L mm		
0	25	200	008610250
1	25	200	008610255
2	25	200	008610260
2L	50	100	008610263
3	25	200	008610265
4	25	100	008610270

861PZ

inserti per avvitatori per viti con impronta a croce Pozidriv® - Supadriv®



ISO 2351-2

ISO 1173 C 6,3

PZ	L mm		
1	25	10	008610300
2	25	10	008610305
2L	50	10	008610308
3	25	10	008610310
4	25	10	008610315

861PZ/C

inserti per avvitatori per viti con impronta a croce Pozidriv® - Supadriv®



ISO 2351-2

ISO 1173 C 6,3

PZ	L mm		
1	25	200	008610350
2	25	200	008610355
2L	50	100	008610358
3	25	200	008610360
4	25	100	008610365

861PE

inserti maschio esagonale per avvitatori



ISO 2351-3

ISO 1173 C 6,3

mm	L mm		
2	25	10	008610100
2,5	25	10	008610105
3	25	10	008610110
4	25	10	008610115
5	25	10	008610120
6	25	10	008610125
8	25	10	008610130
10	25	10	008610135

861TX

inserti per avvitatori per viti con impronta Torx®



ISO 1173 C 6,3

T	L mm		
T5	25	10	008610399
T6	25	10	008610400
T7	25	10	008610405
T8	25	10	008610410
T9	25	10	008610415
T10	25	10	008610420
T15	25	10	008610425
T20	25	10	008610430
T25	25	10	008610435
T27	25	10	008610440
T30	25	10	008610445
T40	25	10	008610450

861TX/C

inserti per avvitatori per viti con impronta Torx®



ISO 1173 C 6,3

T	L mm		
T10	25	200	008610470
T15	25	200	008610475
T20	25	200	008610480
T25	25	200	008610485
T27	25	200	008610490
T30	25	200	008610495
T40	25	200	008610499

861RTX

inserti per avvitatori per viti con impronta Tamper Resistant Torx®



ISO 1173 C 6,3

T	L mm		
T7	25	10	008610538
T9	25	10	008610500
T10	25	10	008610505
T15	25	10	008610510
T20	25	10	008610515
T25	25	10	008610520
T27	25	10	008610525
T30	25	10	008610530
T40	25	10	008610535
T45	25	10	008610539

861RIBE

inserti per avvitatori per viti con impronta RIBE®



ISO 1173 C 6,3

M	L mm		
M5	25	10	008610705
M6	25	10	008610706
M7	25	10	008610707
M8	25	10	008610708
M9	25	10	008610709

861TRW

inserti per avvitatori
per viti con impronta Tri-Wing®



ISO 1173 C 6,3

GR	L mm		
1	25	10	008610601
2	25	10	008610602
3	25	10	008610603
4	25	10	008610604
5	25	10	008610605
6	25	10	008610606

861TQS

inserti per avvitatori
per viti con impronta Torq-Set®



ISO 1173 C 6,3

GR	L mm		
0	25	10	008610620
1	25	10	008610621
2	25	10	008610622
3	25	10	008610623
4	25	10	008610624
5	25	10	008610625
6	25	10	008610626
8	25	10	008610628
10	25	10	008610630

861SP

inserti per avvitatori per viti con impronta
Spanner



ISO 1173 C 6,3

SP	D mm	L mm		
4	1,5	25	10	008610650
6	2,4	25	10	008610653
8	2,8	25	10	008610656
10	3,3	25	10	008610658
12	3,9	25	10	008610660

861XZN

inserti per avvitatori
per viti con impronta XZN®



ISO 1173 C 6,3

Ø	L mm		
M5	25	10	008610725
M6	25	10	008610726
M8	25	10	008610728

861/C61P

61 inserti per avvitatori e 1 portainseriti
magnetico a sgancio rapido



861/C61P

1 008610978

	861LP	0,5x3 - 0,6x4,5 - 0,8x5,5 - 1,0x5,5 1,2x6,5 - 1,2x8 - 1,6x8 mm
	861PE	2 - 2,5 - 3 - 4 - 5 - 6 - 8 - 10 mm
	861PH	PH0 - PH1 - PH2 - PH3
	861PZ	PZ1 - PZ2 - PZ3
	861TX	T6 - T7 - T8 - T9 - T10 - T15 T20 - T25 - T27 - T30 - T40
	861RTX	T9 - T10 - T15 - T20 - T25 T27 - T30 - T40
	861TRW	1 - 2 - 3 - 4 - 5 - 6
	861TQS	0 - 1 - 2 - 3 - 4 - 5 - 6 - 8 - 10
	861SP	4 - 6 - 8 - 10 - 12
	851SR	Ø 1/4"

270x120x45 mm - 975 g

862LP

inserti per avvitatori
per viti a testa con intaglio



ISO 2351-1

ISO 1173 E 6,3

SxA mm	L mm		
0,5x3	50	5	008620005
0,6x4,5	50	5	008620010
0,8x5,5	50	5	008620015
1x5,5	50	5	008620020
1,2x6,5	50	5	008620025
1,2x8	50	5	008620030
1,6x8	50	5	008620035

862PH

inserti per avvitatori
per viti con impronta a croce Phillips®



ISO 2351-2

ISO 1173 E 6,3

PH	L mm		
1	50	5	008620200
2	50	5	008620205
3	50	5	008620210

862PH/L

inserti per avvitatori per viti
con impronta a croce Phillips®



ISO 2351-2

ISO 1173 E 6,3

PH	L mm		
1	70	5	008620230
2	70	5	008620232
3	70	5	008620234

862PZ

inserti per avvitatori
per viti con impronta a croce
Pozi driv® - Supadriv®



ISO 2351-2

ISO 1173 E 6,3

PZ	L mm		
1	50	5	008620300
2	50	5	008620305
3	50	5	008620310

862PE

inserti maschio esagonale
per avvitatori



ISO 2351-3

ISO 1173 E 6,3

mm	L mm		
3	50	5	008620103
4	50	5	008620104
5	50	5	008620105
6	50	5	008620106
8	50	5	008620108

862TX

inserti per avvitatori per viti
con impronta Torx®



ISO 1173 E 6,3

Ø	L mm		
T9	50	5	008620509
T10	50	5	008620510
T15	50	5	008620515
T20	50	5	008620520
T25	50	5	008620525
T27	50	5	008620527
T30	50	5	008620530
T40	50	5	008620540

862TX/L

inserti per avvitatori per viti con impronta Torx®



ISO 1173 E 6,3

	L mm		
T9	70	5	008620559
T10	70	5	008620560
T15	70	5	008620565
T20	70	5	008620570
T25	70	5	008620575
T27	70	5	008620577
T30	70	5	008620580
T40	70	5	008620590

862F

inserti per avvitatori chiavi a bussola esagonale magnetici



ISO 1173 E 6,3

mm	L mm	Ø mm	
5,5	65	11	5 008620405
6	65	11	5 008620406
7	65	11	5 008620407
8	65	13	5 008620408
10	65	15	5 008620410
12	65	18	5 008620412
13	65	18	5 008620413

862F/A7

7 inserti per avvitatori chiavi a bussola esagonale magnetici, in astuccio tascabile



862F/A7 1 008620950

862F 5,5-6-7-8-10-12-13 mm

866LP

inserti per avvitatori per viti a testa con intaglio



ISO 2351-1

ISO 1173 C 8

SxA mm	L mm		
1x5,5	41	10	008660005
1,2x6,5	41	10	008660010
1,6x8	41	10	008660015
1,6x10	41	10	008660020
2x12	41	10	008660025

866PH

inserti per avvitatori per viti con impronta a croce Phillips®



ISO 2351-2

ISO 1173 C 8

PH	L mm		
1	32	10	008660200
2	32	10	008660205
3	32	10	008660210
4	38	10	008660215

866PZ

inserti per avvitatori per viti con impronta a croce Pozidriv® - Supadriv®



ISO 2351-2

ISO 1173 C 8

PZ	L mm		
1	32	10	008660300
2	32	10	008660305
3	32	10	008660310
4	38	10	008660315

866PE

inserti maschio esagonale per avvitatori



ISO 2351-3

ISO 1173 C 8

mm	L mm		
3	30	10	008660100
4	30	10	008660105
5	30	10	008660110
6	30	10	008660115
7	30	10	008660117
8	30	10	008660120
10	30	10	008660125
12	30	10	008660132
14	30	10	008660134

866TX

inserti per avvitatori per viti con impronta Torx®



ISO 1173 C 8

	L mm		
T20	30	10	008660400
T25	30	10	008660405
T27	30	10	008660410
T30	30	10	008660415
T40	30	10	008660420
T45	30	10	008660425
T50	30	10	008660430
T55	30	10	008660435
T60	30	10	008660440
T70	30	10	008660445

866RTX

inserti per avvitatori per viti con impronta Tamper Resistant Torx®



ISO 1173 C 8

	L mm		
T40	30	10	008660520
T45	30	10	008660525
T50	30	10	008660530
T55	30	10	008660535
T60	30	10	008660540
T70	30	10	008660545

867PE

inserti maschio esagonale



mm	L mm		
4	30	5	008670104
5	30	5	008670105
6	30	5	008670106
7	30	5	008670107
8	30	5	008670108
10	30	5	008670110
12	30	5	008670112

867PE/L

inserti maschio esagonale



mm	L mm		
4	75	5	008670154
5	75	5	008670155
6	75	5	008670156
7	75	5	008670157
8	75	5	008670158
10	75	5	008670160
12	75	5	008670162

867XZN

inserti a profilo XZN®



	L mm		
M4	30	5	008670204
M5	30	5	008670205
M6	30	5	008670206
M8	30	5	008670208
M10	30	5	008670210
M12	30	5	008670212

867XZN/L

inserti a profilo XZN®



Ø	L		
mm	mm		
M5	75	5	008670255
M6	75	5	008670256
M8	75	5	008670258
M10	75	5	008670260
M12	75	5	008670262

867TX

inserti per viti con impronta Torx®



Ø	L		
mm	mm		
T20	30	5	008670400
T25	30	5	008670405
T30	30	5	008670410
T40	30	5	008670415
T45	30	5	008670420
T50	30	5	008670425
T55	30	5	008670430

867TX/L

inserti per viti con impronta Torx®



Ø	L		
mm	mm		
T20	75	5	008670450
T25	75	5	008670455
T30	75	5	008670460
T40	75	5	008670465
T45	75	5	008670470
T50	75	5	008670475
T55	75	5	008670480

867RTX

inserti per viti con impronta
Tamper Resistant Torx®



Ø	L		
mm	mm		
T20	30	5	008670500
T25	30	5	008670505
T30	30	5	008670510
T40	30	5	008670515
T45	30	5	008670520
T50	30	5	008670525
T55	30	5	008670530

867RTX/L

inserti per viti con impronta
Tamper Resistant Torx®



Ø	L		
mm	mm		
T20	75	5	008670550
T25	75	5	008670555
T30	75	5	008670560
T40	75	5	008670565
T45	75	5	008670570
T50	75	5	008670575
T55	75	5	008670580

867/...

bussole portainseri per 867



	Ø	□	L	Ø		
	mm	mm	mm	mm		
867/1	10	3/8"	38	17	5	008670600
867/2	10	1/2"	38	22	5	008670601

867/C52

52 inserti con attacco esagonale 10 mm
e 2 accessori

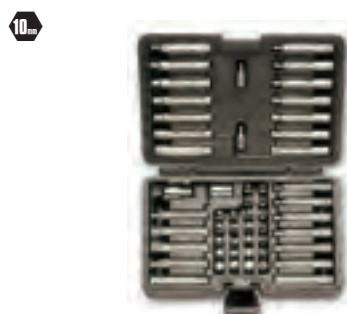

867/C52		
	1	008670901

○	867PE	4-5-6-7-8-10-12 mm
○	867PE/L	4-5-6-7-8-10-12 mm
○	867XZN	M5-M6-M8-M10-M12
○	867XZN/L	M5-M6-M8-M10-M12
⊕	867TX	T20-T25-T30-T40-T45-T50-T55
⊕	867TX/L	T20-T25-T30-T40-T45-T50-T55
⊕	867RTX	T20-T25-T30-T40-T45-T50-T55
⊕	867RTX/L	T20-T25-T30-T40-T45-T50-T55
	867/1	○ 10 mm - □ 3/8"
	867/2	○ 10 mm - □ 1/2"

250x170x70 mm - 2,1 kg

882

portainseri con anello di ritegno
per avvitatori



ISO 1173 E 6,3

L	Ø	Ø		
mm	mm	mm		
57	1/4	1/4	11	5 008820001

882M1

portainseri magnetico
per avvitatori



ISO 1173 E 6,3

L	Ø	Ø		
mm	mm	mm		
50	1/4	1/4	11	5 008820006

882M

portainseri magnetico
per avvitatori



ISO 1173 E 6,3

L	Ø	Ø		
mm	mm	mm		
75	1/4	1/4	11	5 008820005

882MSR

portainseri magnetico a sgancio rapido per
avvitatori



ISO 1173 E 6,3

L	Ø	Ø		
mm	mm	mm		
50	1/4	1/4	11	5 008820205
75	1/4	1/4	11	5 008820207

882P

prolunga portainseri magnetica



L	Ø	Ø		
mm	mm	mm		
80	1/4	1/4	10	5 008820080

892

raccordi per avvitatori



	■	●	L mm		
892/0	1/4	1/4	25	5	008920000
* 892/1	1/4	5,5	50	5	008920001
* 892/2	3/8	5,5	50	5	008920002
° 892/3	1/4	1/4	50	5	008920003
° 892/4	3/8	1/4	50	5	008920004
892/5	1/4	5/16	75	5	008920005
892/6	3/8	5/16	75	5	008920006
892/7	1/2	1/4	75	5	008920007

* ISO 1173 A 5,5
° ISO 1173 C 6,3

895

bussole portainseri
per 860, 861, 862, 866



DIN 7427

	○	□	L mm	Ø mm	
895/1	1/4	1/4	25,4	12	5 008950000
895/3	1/4	3/8	29	16,8	5 008950001
895/4	5/16	3/8	29	16,8	5 008950002
895/5	1/4	1/2	38	22	5 008950005
895/6	5/16	1/2	38	22	5 008950003

897

portainseri flessibile
con impugnatura

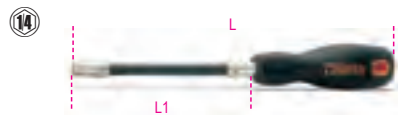

L mm	L1 mm	
280	154	2 008970010

897L

portainseri flessibile con impugnatura
modello lungo



L mm	L1 mm	
500	380	2 008970015

900

chiavi a bussola a mano
bocca esagonale



UNI/ISO 2725 DIN 3124

mm	Ø mm	L mm	Ø1 mm	
4	6,8	25	11,8	10 009000040
4,5	7,4	25	11,8	10 009000045
5	8,0	25	11,8	10 009000050
5,5	8,7	25	11,8	10 009000055
6	9,3	25	11,8	10 009000060
7	10,4	25	11,8	10 009000070
8	11,8	25	12,7	10 009000080
9	12,7	25	11,8	10 009000090
10	14,2	25	12,0	10 009000100
11	15,8	25	12,5	10 009000110
12	17,2	25	13,5	10 009000120
13	18,0	25	13,5	10 009000130
14	20,0	25	15,0	10 009000140



900/SB13

4-4,5-5-5,5-6-7-8-9
10-11-12-13-14 mm

1 009000150

900MB

chiavi a bussola a mano
bocca poligonale



UNI/ISO 2725 DIN 3124

mm	Ø mm	L mm	Ø1 mm	
4	7,7	22	11,2	5 009000160
5	8,0	25	11,8	5 009000161
5,5	8,7	25	11,8	5 009000162
6	9,3	25	11,8	5 009000163
7	10,4	25	11,8	5 009000164
8	11,8	25	12,7	5 009000165
9	12,7	25	11,8	5 009000166
10	14,2	25	12,0	5 009000167
11	15,8	25	12,5	5 009000168
12	17,2	25	13,5	5 009000169
13	18,0	25	13,5	5 009000170
14	20,0	25	15,0	5 009000171



900MB/SB12

4-5-5,5-6-7-8-9-10
11-12-13-14 mm

1 009000179

900L

chiavi a bussola a mano lunghe
bocca esagonale



UNI/ISO 2725 DIN 3124

mm	Ø mm	L mm	Ø1 mm	
4	6,5	50	12,0	5 009000181
4,5	7,0	50	12,0	5 009000182
5	7,5	50	12,0	5 009000183
5,5	8,5	50	12,0	5 009000184
6	9,5	50	12,0	5 009000185
7	10,5	50	12,0	5 009000186
8	12,0	50	12,0	5 009000187
9	13,0	50	13,0	5 009000188
10	14,0	50	14,0	5 009000189
11	16,0	50	16,0	5 009000190
12	17,5	50	17,5	5 009000191
13	17,5	50	17,5	5 009000192
14	20,0	50	20,0	5 009000193



900L/SB13

4-4,5-5-5,5-6-7-8-9-10-11-12-13-14 mm

1 009000203

900MB/L

chiavi a bussola a mano lunghe
bocca poligonale

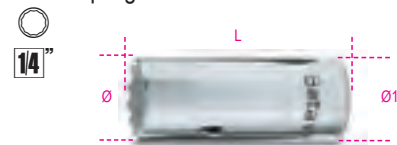

UNI/ISO 2725 DIN 3124

mm	Ø mm	L mm	Ø1 mm	
5	8,0	50	12,0	3 009000211
6	9,3	50	12,0	3 009000212
7	10,9	50	12,0	3 009000213
8	11,6	50	12,0	3 009000214
9	13,0	50	12,0	3 009000215
10	14,3	50	12,8	3 009000216
11	16,0	50	14,2	3 009000217
12	17,4	50	15,5	3 009000218
13	18,0	50	16,2	3 009000219
14	19,0	50	17,1	3 009000220

900AS

chiavi a bussola a mano
bocca esagonale



mm	Ø mm	L mm	Ø1 mm	
5/32	8,8	25	11,9	5 009000349
3/16	7,7	25	11,9	5 009000340
7/32	8,8	25	11,9	5 009000345
1/4	9,6	25	11,9	5 009000350
9/32	10,2	25	11,9	5 009000355
5/16	11,3	25	11,9	5 009000360
11/32	12,7	25	11,6	5 009000365
3/8	14,0	25	12,9	5 009000370
7/16	15,3	25	14,5	5 009000375
1/2	17,5	25	16,4	5 009000380
9/16	19,0	25	17,9	5 009000385



900AS/SB11

3/16-7/32-5/32-1/4-9/32-5/16-11/32-3/8-7/16-1/2-9/16

1 009000389

900AS/MB

chiavi a bussola a mano
bocca poligonale



SAE AS 954E

"	Ø mm	L mm	Ø1 mm		
3/16	8,0	22	10,0	2	009000390
7/32	8,6	22	10,0	2	009000391
1/4	9,6	22	10,0	2	009000392
9/32	10,0	22	10,0	2	009000393
5/16	11,9	22	11,9	2	009000394
11/32	12,0	22	12,0	2	009000395
3/8	13,9	22	13,9	2	009000396
7/16	15,2	22	15,2	2	009000397
1/2	17,2	22	17,2	2	009000398
9/16	19,0	24	19,0	2	009000399

900AS/L

chiavi a bussola a mano lunghe
bocca esagonale



"	Ø mm	L mm	Ø1 mm		
3/16	7,0	50	12,0	2	009000301
7/32	8,5	50	12,0	2	009000303
1/4	9,8	50	12,0	2	009000305
9/32	10,5	50	12,0	2	009000307
5/16	12,0	50	12,0	2	009000309
11/32	13,0	50	13,0	2	009000311
3/8	14,0	50	14,0	2	009000313
7/16	16,0	50	16,0	2	009000315
1/2	17,5	50	17,5	2	009000317
9/16	20,0	50	20,0	2	009000319

900AS/MBL

chiavi a bussola a mano lunghe
bocca poligonale



"	Ø mm	L mm	Ø1 mm		
5/32	6,8	50	12,0	2	009000325
3/16	8,0	50	12,0	2	009000326
7/32	8,5	50	12,0	2	009000327
1/4	9,8	50	12,0	2	009000328
9/32	10,9	50	12,0	2	009000329
5/16	11,6	50	12,0	2	009000330
11/32	13,0	50	12,0	2	009000331
3/8	14,3	50	12,8	2	009000332
7/16	16,0	50	14,2	2	009000333
1/2	18,0	50	16,2	2	009000334
9/16	19,0	50	17,1	2	009000335

900FTX

chiavi a bussola a mano per viti
con teste a profilo Torx®



"	Ø mm	L mm	Ø1 mm		
E4	5,4	22	11,2	5	009000404
E5	6,7	22	11,2	5	009000405
E6	7,7	22	11,2	5	009000406
E7	8,3	22	11,2	5	009000407
E8	9,6	22	11,2	5	009000408
E10	11,3	22	12,0	5	009000410
E11	12,1	22	12,5	5	009000411
E12	12,9	23	12,9	5	009000412
E14	14,0	25	14,0	5	009000414



900FTX/SB9

E4-E5-E6-E7-E8
E10-E11-E12-E14

1 009000419

900LP

chiavi a bussola a giravite
per viti con intaglio



SxA mm	Ø mm	L mm	L1 mm		
0,8x4	12	28	9	5	009000605
1x5,5	12	28	9	5	009000610
1,2x6,5	12	28	9	5	009000615
1,2x8	13	28	8	5	009000620
1,6x10	14	28	8	5	009000625

900PH

chiavi a bussola a giravite
per viti con impronta a croce Phillips®



PH	Ø mm	L mm	L1 mm		
1	12	28	12	5	009000701
2	12	28	12	5	009000702
3	12	28	12	5	009000703
4	13	28	11	5	009000704

900ME

chiavi a bussola a giravite
maschio esagonale



mm	Ø mm	L mm	L1 mm		
2,5	12	25	4,5	5	009000502
3	12	25	5,0	5	009000503
4	12	25	5,6	5	009000504
5	12	25	6,3	5	009000505
6	12	25	7,6	5	009000506
7	13	25	7,2	5	009000507
8	13	25	8,0	5	009000508
10	13	25	8,7	5	009000510



900ME/SB8

2,5-3-4-5-6-7-8-10 mm

1 009000518

900PT

chiavi a bussola a giravite per viti con
impronta pentalobata



PT	Ø mm	L mm	L1 mm		
PT10	12	28	12	5	009000750
PT15	12	28	12	5	009000755
PT20	12	28	12	5	009000760
PT25	12	28	12	5	009000765
PT27	12	28	12	5	009000767
PT30	12	28	12	5	009000770

900TX

chiavi a bussola a giravite maschio
per viti con impronta Torx®



T	Ø mm	L mm	L1 mm		
T9	12	28	12	5	009000720
T10	12	28	12	5	009000721
T15	12	28	12	5	009000722
T20	12	28	12	5	009000723
T25	12	28	12	5	009000724
T27	12	28	12	5	009000725
T30	12	28	12	5	009000726
T40	12	28	12	5	009000727



900TX/SB8

T9-T10-T15-T20
T25-T27-T30-T40

1 009000730

900/16

raccordo con attacco quadro femmina 1/4" e maschio 3/8"



UNI/ISO 3316 DIN 3123

L mm	Ø mm	□	■	5 009000814
28	13,0	1/4	3/8	

900/...

prolunghe con attacchi quadri maschio e femmina 1/4"

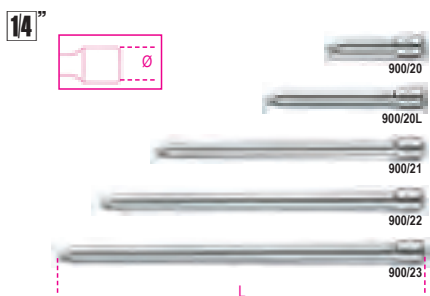

UNI/ISO 3316 DIN 3123

	L mm	Ø mm	5 009000818
900/20	50	11,5	
900/20L	100	11,5	
900/21	150	11,5	
900/22	250	11,5	
900/23	350	11,5	

900AN

prolunghe con attacchi quadri maschio e femmina 1/4" angolari

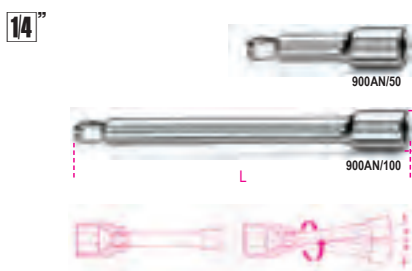

	L mm	Ø mm	3 009000825
900AN/50	50	11,5	
900AN/100	100	11,5	

900FL

prolunga flessibile con attacchi quadri maschio e femmina 1/4"



L mm	Ø mm	3 009000828
150	12	

900/25

snodo con attacchi quadri maschio e femmina 1/4"



UNI/ISO 3316 DIN 3123

L mm	Ø mm	5 009000830
41	12,5	

900BG/30C

quadro maschio 1/4" con impugnatura

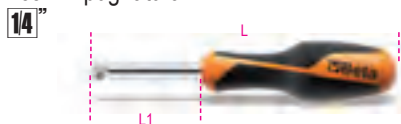

UNI/ISO 3315 DIN 3122

L mm	L1 mm	5 009000833
128	20	

900BG/30

quadro maschio 1/4" con impugnatura

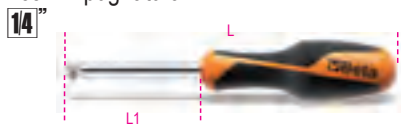

UNI/ISO 3315 DIN 3122

L mm	L1 mm	5 009000834
176	68	

900/32

quadro maschio 1/4" flessibile con impugnatura

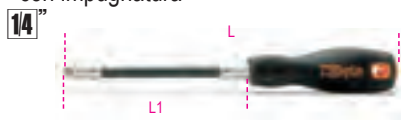

L mm	L1 mm	2 009000839
280	154	

900/35A

quadro maschio 1/4" snodato con impugnatura

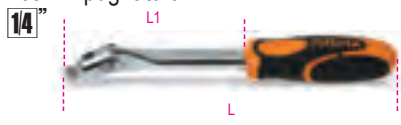

UNI/ISO 3315 DIN 3122

L mm	L1 mm	5 009000840
148	84	

900M/35

quadro maschio 1/4" snodato con impugnatura in metallo



UNI/ISO 3315
DIN 3122

L mm	3 009000845
130	

900/40

quadro maschio 1/4" snodato a T



L mm	L1 mm	3 009000843
390	145	

900/42

quadro maschio 1/4" con spina scorrevole



UNI/ISO 3315 DIN 3122

L mm	A mm	5 009000854
115	22	

900T/44

quadro maschio 1/4" piegato con impugnatura di manovra



L mm	L1 mm	2 009000860
238	105	

900/55

cricchetto reversibile con attacco quadro maschio 1/4" meccanismo a 48 denti



UNI/ISO 3315 DIN 3122

L mm	Ø mm	A mm	5 009000870
125	25	18	

900M/55

cricchetto reversibile con attacco quadro maschio 1/4" con impugnatura in metallo



UNI/ISO 3315
DIN 3122

L mm	Ø mm	A mm	3 009000905
110	22	18	

900/58

cricchetto reversibile
con impugnatura rotante
con attacco quadro maschio 1/4"
meccanismo a 52 denti

- Pulsante di rilascio della bussola
- Sistema di inversione a ghiera sulla testa del cricchetto
- Impugnatura bimateriale



L mm	Ø mm	A mm	2	009000884
126	28	28,5		

**Meccanismi rotanti
di ricambio dei cricchetti,
vedi tabella dopo l'art. 929/C8**

900/C39

11 chiavi a bussola esagonali, 21 inserti e 7 accessori



900/C39 1 009000937

	861LP	0,6x4,5 - 1,2x6,5 - 1,2x8 mm
	861PH	PH1-PH2-PH3
	861PZ	PZ1-PZ2-PZ3
	861PE	2,5-3-4-5-6 mm
	861RTX	T10-T15-T20-T25-T27-T30-T40
	900	5-5,5-6-7-8-9-10-11-12-13-14 mm
	900/20	50 mm
	900/20L	100 mm
	900/25	
	900BG/30C	
	900/55	
	892/0	
	895/1	

900/C11

11 chiavi a bussola esagonali,
20 inserti per avvitatori e 8 accessori



900/C11 1 009000971

	861LP	0,5x3 - 0,8x5,5 1x5,5 - 1,2x6,5 mm
	861PE	3 - 4 - 5 - 6 - 8 mm
	861PH	0 - 1 - 2 - 3
	861TX	T8 - T10 - T15 - T20 T25 - T30 - T40
	895/1	
	900	5 - 5,5 - 6 - 7 - 8 - 9 - 10 11 - 12 - 13 - 14 mm
	900/16	□ 1/4 - ■ 3/8
	900/20	50 mm
	900/21	150 mm
	900/25	
	900BG/30	
	900/42	
	900/55	

270x120x45 mm - 1,2 kg

900/C13-5

13 chiavi a bussola esagonali
e 5 accessori



900/C13-5 1 009000953

	900	4 - 4,5 - 5 - 5,5 - 6 - 7 - 8 - 9 10 - 11 - 12 - 13 - 14 mm
	900/21	150 mm
	900/25	
	900BG/30	
	900/42	
	900/55	

270x120x45 mm - 1 kg

900/C13-8

13 chiavi a bussola esagonali
e 8 accessori



900/C13-8 1 009000954

	900	4 - 4,5 - 5 - 5,5 - 6 - 7 - 8 - 9 10 - 11 - 12 - 13 - 14 mm
	900/16	□ 1/4 - ■ 3/8
	900/20	50 mm
	900/21	150 mm
	900/25	
	900BG/30	
	900/35A	
	900/42	
	900/55	

270x120x45 mm - 1,1 kg

900MB/C19

11 chiavi a bussola poligonali
e 8 accessori



900MB/C19 1 009000977

	900MB	5 - 5,5 - 6 - 7 - 8 - 9 - 10 - 11 12 - 13 - 14 mm
	900/16	□ 1/4 - ■ 3/8
	900/20	50 mm
	900/21	150 mm
	900/25	
	900BG/30	
	900/35A	
	900/42	
	900/55	

270x120x45 mm - 1,1 kg

900/C24

13 chiavi a bussola esagonali
11 a giravite e 6 accessori

1/4"



900/C24

1 009000956

	○ 900	4 - 4,5 - 5 - 5,5 - 6 - 7 - 8 - 9 10 - 11 - 12 - 13 - 14 mm
	● 900LP	0,8x4 - 1,2x6,5 - 1,2x8 mm
	⊕ 900PH	PH1 - PH2 - PH3
	○ 900ME	3 - 4 - 5 - 6 - 8 mm
	900/20	50 mm
	900/21	150 mm
	900/25	
	900BG/30	
	900/42	
	⊕ 900/55	

270x120x45 mm - 1,1 kg

900MB/C28

11 chiavi a bussola poligonali
11 a giravite e 6 accessori

1/4"



900MB/C28

1 009000979

	○ 900MB	5 - 5,5 - 6 - 7 - 8 - 9 - 10 - 11 12 - 13 - 14 mm
	● 900LP	0,8x4 - 1,2x6,5 - 1,2x8 mm
	⊕ 900PH	PH1 - PH2 - PH3
	○ 900ME	3 - 4 - 5 - 6 - 8 mm
	900/20	50 mm
	900/21	150 mm
	900/25	
	900BG/30	
	900/42	
	⊕ 900/55	

270x120x45 mm - 1,1 kg

900AS/C10 - /MB-C17

10 chiavi a bussola
e 7 accessori

1/4"



900AS/C10

1 009000961

	○ 900AS	3/16 - 7/32 - 1/4 - 9/32 - 5/16 11/32 - 3/8 - 7/16 - 1/2 - 9/16
	900/20	50 mm
	900/21	150 mm
	900/25	
	900BG/30	
	900/35A	
	900/42	
	⊕ 900/55	

270x120x45 mm - 1,1 kg

900AS/MB-C17

1 009000981

	○ 900AS/MB	3/16 - 7/32 - 1/4 - 9/32 - 5/16 11/32 - 3/8 - 7/16 - 1/2 - 9/16
	900/20	50 mm
	900/21	150 mm
	900/25	
	900BG/30	
	900/35A	
	900/42	
	⊕ 900/55	

270x120x45 mm - 1,1 kg

900AS/C17-MBM

10 chiavi a bussola poligonali
e 7 accessori
per manutenzioni aeronautiche

1/4"



900AS/C17-MBM

1 009000982

	○ 900AS/MB	3/16 - 7/32 - 1/4 - 9/32 - 5/16 11/32 - 3/8 - 7/16 - 1/2 - 9/16
	900/20	50 mm
	900/21	150 mm
	900/25	
	900BG/30	
	900M/35	
	900/42	
	900M/55	

270x120x45 mm - 1,2 kg

900/C11HR

11 chiavi a bussola esagonali,
20 inserti per avvitatori e 7 accessori
in termoformato rigido,
in cassetta di lamiera

• cricchetto con impugnatura rotante

1/4"

1/4"



900/C11HR

1 009000980

	● 861LP	0,5x3-0,8x5,5-1x5,5-1,2x6,5 mm
	⊕ 861PH	PH0-PH1-PH2-PH3
	○ 861PE	3-4-5-6-8 mm
	⊖ 861TX	T8-T10-T15-T20-T25-T30-T40
	895/1	
	○ 900	5-5,5-6-7-8-9-10-11-12-13-14 mm
	900/16	□ 1/4 - ■ 3/8
	900/20	50 mm
	900/21	150 mm
	900/25	
	900/42	
	900/30	
	900/58	

350x150x50 mm - 1,3 kg

902R/C6

6 raccordi per chiavi a bussola



902R/C6

1 009020814

	900/16	□ 1/4 - ■ 3/8
	910/15	□ 3/8 - ■ 1/4
	910/16	□ 3/8 - ■ 1/2
	920/15	□ 1/2 - ■ 3/8
	920/16	□ 1/2 - ■ 3/4
	928/15	□ 3/4 - ■ 1/2

170x100x35 mm - 600 g

910A

chiavi a bussola a mano
bocca esagonale

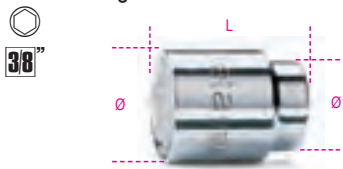

UNI/ISO 2725 DIN 3124

mm	Ø	L	Ø1		
6	9,5	28	16,7	5	009100006
7	10,7	28	16,7	5	009100007
8	12,1	28	16,7	5	009100008
9	13,2	28	16,7	5	009100009
10	14,6	29	16,7	5	009100010
11	15,8	29	16,7	5	009100011
12	17,2	30	17,7	5	009100012
13	18,4	31	17,0	5	009100013
14	19,7	32	17,5	5	009100014
15	20,9	32	18,0	5	009100015
16	22,2	33	18,5	5	009100016
17	23,2	33	19,0	5	009100017
18	24,7	34	20,0	5	009100018
19	25,8	35	21,0	5	009100019
20	27,2	35	22,0	5	009100020
21	28,2	36	23,0	5	009100021
22	29,7	37	24,0	5	009100022



910A/SB17

6-7-8-9-10-11-12
13-14-15-16-17
18-19-20-21-22 mm

1 009100030

910B

chiavi a bussola a mano
bocca poligonale

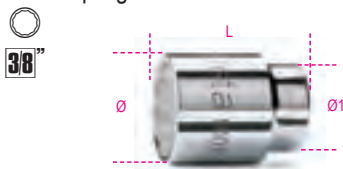

UNI/ISO 2725 DIN 3124

mm	Ø	L	Ø1		
6	9,5	28	16,7	5	009100106
7	10,7	28	16,7	5	009100107
8	12,1	28	16,7	5	009100108
9	13,2	28	16,7	5	009100109
10	14,6	29	16,7	5	009100110
11	15,8	29	16,7	5	009100111
12	17,2	30	17,7	5	009100112
13	18,4	31	17,0	5	009100113
14	19,7	32	17,5	5	009100114
15	20,9	32	18,0	5	009100115
16	22,2	33	18,5	5	009100116
17	23,2	33	19,0	5	009100117
18	24,7	34	20,0	5	009100118
19	25,8	35	21,0	5	009100119
20	27,2	35	22,0	5	009100120
21	28,2	36	23,0	5	009100121
22	29,7	37	24,0	5	009100122



910B/SB17

6-7-8-9-10-11-12
13-14-15-16-17
18-19-20-21-22 mm

1 009100130

Beta

910AL

chiavi a bussola a mano lunghe
bocca esagonale



UNI/ISO 2725 DIN 3124

mm	Ø	L	Ø1		
8	12,0	55	17	3	009100158
9	13,0	55	17	3	009100159
10	14,5	55	17	3	009100160
11	16,0	55	17	3	009100161
12	17,0	55	17	3	009100162
13	18,0	55	17	3	009100163
14	20,0	55	18	3	009100164
15	21,0	55	20	3	009100165
16	22,0	55	20	3	009100166
17	23,5	55	22	3	009100167
18	24,5	55	23	2	009100168
19	25,0	55	24	2	009100169
21	27,0	65	26	2	009100171
22	29,0	65	28	2	009100172



910AL/SB14

8-9-10-11-12-13-14
15-16-17-18-19-21-22 mm

1 009100174

910BL

chiavi a bussola a mano lunghe
bocca poligonale



UNI/ISO 2725 DIN 3124

mm	Ø	L	Ø1		
8	12,0	55	17	3	009100308
9	13,0	55	17	3	009100309
10	14,5	55	17	3	009100310
11	16,0	55	17	3	009100311
12	17,0	55	17	3	009100312
13	18,0	55	17	3	009100313
14	20,0	55	18	3	009100314
15	21,0	55	20	3	009100315
16	22,0	55	20	3	009100316
17	23,5	55	22	3	009100317
18	24,5	55	23	2	009100318
19	25,0	55	24	2	009100319
21	27,0	65	26	2	009100321
22	29,0	65	28	2	009100322



910BL/SB14

8-9-10-11-12-13
14-15-16-17-18
19-21-22 mm

1 009100340

910B/SN

chiavi a bussola a mano snodate
bocca poligonale

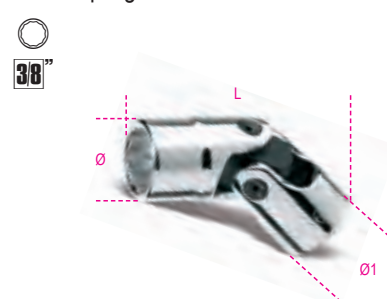

mm	Ø	L	Ø1		
10	14,5	48,5	19	2	009100230
11	15,8	49,5	19	2	009100231
12	17,0	50,0	19	2	009100232
13	18,3	51,0	19	2	009100233
14	19,5	51,0	19	2	009100234
15	20,8	53,5	19	2	009100235
16	22,0	53,5	19	2	009100236
17	23,3	54,5	19	2	009100237
18	24,5	54,5	19	2	009100238
19	25,8	56,5	19	2	009100239

910A/AS

chiavi a bussola a mano
bocca esagonale



"	Ø	L	Ø1		
1/4	10,3	26	17,3	5	009100276
5/16	11,9	26	17,3	5	009100278
11/32	13,3	26	17,3	5	009100279
3/8	13,9	26	17,3	5	009100280
7/16	15,8	26	17,3	5	009100281
1/2	17,9	26	17,3	5	009100283
9/16	19,5	27	18,5	5	009100284
19/32	20,6	27	19,5	5	009100285
5/8	21,9	28	20,0	5	009100286
11/16	24,6	30	22,5	5	009100287
3/4	25,9	30	23,5	5	009100289
13/16	27,9	32	26,0	5	009100291
7/8	29,6	32	26,5	5	009100292



910A/AS/SB13

1/4-5/16-11/32-3/8-7/16
1/2-9/16-19/32-5/8-11/16
3/4-13/16-7/8

1 009100295

910AS

chiavi a bussola a mano
bocca poligonale



"	Ø	L	Ø1		
1/4	9,5	28	16,7	5	009100201
5/16	12,1	28	16,7	5	009100202
11/32	13,2	28	16,7	5	009100203

"	Ø mm	L mm	Ø1 mm		
3/8	14,6	29	16,7	5	009100204
7/16	15,8	29	16,7	5	009100205
1/2	18,4	31	17,0	5	009100206
9/16	19,7	32	17,5	5	009100207
19/32	20,9	32	18,0	5	009100208
5/8	22,2	33	18,5	5	009100209
11/16	24,7	34	20,0	5	009100210
3/4	25,8	35	21,0	5	009100211
13/16	28,2	36	23,0	5	009100212
7/8	29,7	37	24,0	5	009100213



910AS/SB13		1 009100215
1/4-5/16-11/32-3/8-7/16		
1/2-9/16-19/32-5/8-11/16		
3/4-13/16-7/8		

910AS/L

chiavi a bussola a mano lunghe
bocca poligonale



"	Ø mm	L mm	Ø1 mm		
1/4	10	55	17	3	009100350
5/16	12	55	17	3	009100351
3/8	14	55	17	3	009100352
7/16	16	55	17	3	009100353
1/2	18	55	17	3	009100354
9/16	20	55	18	3	009100355
19/32	21	55	20	3	009100356
5/8	22	55	20	3	009100357
11/16	23	55	22	3	009100359
3/4	25	55	24	3	009100360
13/16	27	65	26	3	009100362
7/8	29	65	28	3	009100363



910ASL/SB12		1 009100365
1/4-5/16-3/8-7/16		
1/2-9/16-19/32-5/8-11/16		
3/4-13/16-7/8		

910AS/SN

chiavi a bussola a mano snodate
bocca poligonale



* SAE AS 954E

"	Ø mm	L mm	Ø1 mm		
* 3/8	14,0	48,0	19	2	009100260
* 7/16	15,8	51,0	19	2	009100261
* 1/2	18,3	51,0	19	2	009100262
* 9/16	19,5	51,0	19	2	009100263
* 5/8	22,0	53,5	19	2	009100264
11/16	24,5	54,5	19	2	009100265
3/4	25,8	56,5	19	2	009100266

910FTX

chiavi a bussola a mano per viti
con testa a profilo Torx®



"	Ø mm	L mm	Ø1 mm		
E4	6,2	26	17,3	5	009100404
E5	7,0	26	17,3	5	009100405
E6	8,3	26	17,3	5	009100406
E7	8,9	26	17,3	5	009100407
E8	9,9	26	17,3	5	009100408
E10	12,0	26	17,3	5	009100410
E12	14,5	26	17,3	5	009100412
E14	15,8	26	17,3	5	009100414
E16	18,0	26	17,3	5	009100416



910FTX/SB9		1 009100430
E4-E5-E6-E7-E8		
E10-E12-14-E16		

910FTX/L

chiavi a bussola a mano lunghe
per viti con testa a profilo Torx®



"	Ø mm	L mm	Ø1 mm		
E4	6,2	55	17,3	3	009100440
E5	7,0	55	17,3	3	009100441
E6	8,3	55	17,3	3	009100442
E7	8,9	55	17,3	3	009100443
E8	9,9	55	17,3	3	009100444
E10	12,0	55	17,3	3	009100445



910FTX/LSB6		1 009100449
E4-E5-E6		
E7-E8-E10		

910LP

chiavi a bussola a giravite
per viti con intaglio



SxA mm	Ø mm	L mm	L1 mm		
1x5,5	18,5	54	24	2	009100452
1,2x6,5	18,5	54	24	2	009100453
1,2x8	18,5	54	24	2	009100454
1,6x9	18,5	54	24	2	009100456

910PH

chiavi a bussola a giravite
per viti con impronta a croce Phillips®



PH	Ø mm	L mm	L1 mm		
1	18,5	48	18	2	009100471
2	18,5	48	18	2	009100472
3	18,5	48	18	2	009100473
4	18,5	48	18	2	009100474

910PE

chiavi a bussola maschio esagonale

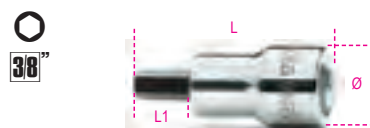

DIN 7422

mm	Ø mm	L mm	L1 mm		
3	18,5	50	20	5	009100490
4	18,5	50	20	5	009100492
5	18,5	50	20	5	009100494
6	18,5	50	20	5	009100496
7	18,5	50	20	5	009100497
8	18,5	50	20	5	009100498
10	18,5	50	20	5	009100500



910PE/SB7		1 009100503
3-4-5-6-7-8-10 mm		

910ME

chiavi a bussola maschio esagonale



mm	Ø mm	L mm	L1 mm		
4	18	62	15	5	009100504
5	18	62	15	5	009100505
6	18	62	15	5	009100506
7	18	62	15	5	009100507
8	19	62	15	5	009100508
10	20	62	15	5	009100510
12	20	62	15	5	009100512



910ME/SB5		1 009100515
4-5-6-8-10 mm		

910PT

chiavi a bussola a giravite per viti con impronta pentalobata



Ø	L	L1	
mm	mm	mm	
PT40	20	50	3 009100540
PT45	20	50	3 009100545
PT50	20	50	3 009100550



910PT/SB8
PT10-PT15-PT20-PT25
PT30-PT40-PT45-PT50

1 009100558

910TX

chiavi a bussola maschio per viti con impronta Torx®



Ø	L	L1	
mm	mm	mm	
T15	18,5	50	5 009100519
T20	18,5	50	5 009100520
T25	18,5	50	5 009100521
T27	18,5	50	5 009100522
T30	18,5	50	5 009100523
T40	18,5	50	5 009100524



910TX/SB6
T15-T20-T25
T27-T30-T40

1 009100530

910CF

chiavi a zampa di gallo



Ø	A	L	
mm	mm	mm	
10	21,3	32,3	2 009100135
11	23,1	34,3	2 009100136
12	25,5	36,2	2 009100137
13	26,9	37,4	2 009100138
14	30,2	40,0	2 009100139
15	33,3	41,3	2 009100140
16	33,3	41,3	2 009100141
17	38,1	46,5	2 009100142
18	38,1	46,5	2 009100143
19	39,6	48,0	2 009100144



910CF/SB10
10-11-12-13-14-15
16-17-18-19 mm

1 009100147

910/15

raccordo con attacco quadro femmina 3/8" e maschio 1/4"



UNI/ISO 3316 DIN 3123

L	Ø			
mm	mm	3/8"	1/4"	
30	17,0			5 009100810



E' assolutamente necessario commisurare la coppia di serraggio alla capacità del quadro maschio per evitare rotture o danni accidentali

910/16

raccordo con attacco quadro femmina 3/8" e maschio 1/2"



UNI/ISO 3316 DIN 3123

L	Ø			
mm	mm	3/8"	1/2"	
32	18,0			5 009100814

910/21 - 910/22

prolunghe con attacchi quadri maschio e femmina 3/8"



UNI/ISO 3316 DIN 3123

	L	Ø	
	mm	mm	
910/21	125	17	5 009100822
910/22	250	17	5 009100826

910AN

prolunghe con attacchi quadri maschio e femmina 3/8" angolari

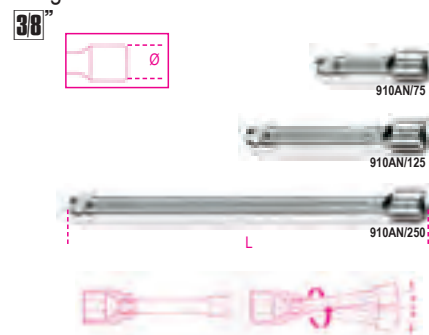

	L	Ø	
	mm	mm	
910AN/75	75	17	3 009100827
910AN/125	125	17	3 009100828
910AN/250	250	17	3 009100829

910/25

snodo con attacchi quadri maschio e femmina 3/8"



UNI/ISO 3316 DIN 3123

L	Ø	
mm	mm	
54,6	19	5 009100830

910M/35

quadro maschio 3/8" snodato con impugnatura in metallo



UNI/ISO 3315 DIN 3122

L	
mm	
250	3 009100839

910/36A

quadro maschio 3/8" snodato con impugnatura



UNI/ISO 3315 DIN 3122

L	L1	
mm	mm	
255	154	3 009100845

910/40

quadro maschio 3/8" snodato a T



L	L1	
mm	mm	
420	175	3 009100850

910/42

quadro maschio 3/8"
con spina scorrevole

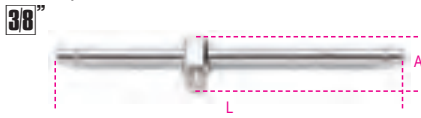

UN/ISO 3315 DIN 3122

L	A
mm	mm
210	30,5

910/46

quadro maschio 3/8"
con manovella

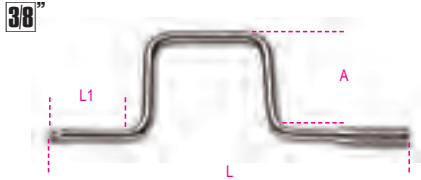

UN/ISO 3315 DIN 3122

L	L1	A
mm	mm	mm
315	80	115

910/55

cricchetto reversibile
con attacco quadro maschio 3/8"
meccanismo a 72 denti



UN/ISO 3315 DIN 3122

L	Ø	A
mm	mm	mm
200	30	33

910/55Q

cricchetto reversibile
con attacco quadro maschio 3/8"
meccanismo a 48 denti



UN/ISO 3315 DIN 3122

L	Ø	A
mm	mm	mm
200	30	33

910M/55

cricchetto reversibile
con attacco quadro maschio 3/8"
con impugnatura in metallo



L	Ø	A
mm	mm	mm
178	30	26

910M/56

cricchetto reversibile snodato
con attacco quadro maschio 3/8"
con impugnatura in metallo



L	Ø	A
mm	mm	mm
265	31	29

910/58

cricchetto reversibile
con impugnatura rotante
con attacco quadro maschio 3/8"
meccanismo a 52 denti

- Pulsante di rilascio della bussola
- Sistema di inversione a ghiera sulla testa del cricchetto
- Impugnatura bimatériale



L	Ø	A
mm	mm	mm
222	37	38,5

**Meccanismi rotanti
di ricambio dei cricchetti,
vedi tabella dopo l'art. 929/C8**

910.../C10

10 chiavi a bussola
e 2 accessori



910A/C10

Ø	910A	6 - 7 - 8 - 10 - 11 - 12 13 - 14 - 17 - 19 mm
910/21	125 mm	
910/55		

270x120x45 mm - 1,3 kg

910B/C10 1 009100910

Ø	910B	6 - 7 - 8 - 10 - 11 - 12 13 - 14 - 17 - 19 mm
910/21	125 mm	
910/55		

270x120x45 mm - 1,3 kg

910A/C16...

16 chiavi a bussola esagonali
e 5 accessori



910A/C16 1 009100936

Ø	910A	6 - 7 - 8 - 9 - 10 - 11 - 12 - 13 14 - 15 - 16 - 17 - 18 - 19 21 - 22 mm
910/21	125 mm	
910/22	250 mm	
910/25		
910/42		
910/55		

335x145x60 mm - 2,3 kg

910A/C16Q 1 009100932

Ø	910A	6 - 7 - 8 - 9 - 10 - 11 - 12 - 13 14 - 15 - 16 - 17 - 18 - 19 21 - 22 mm
910/21	125 mm	
910/22	250 mm	
910/25		
910/42		
910/55Q		

335x145x60 mm - 2,3 kg



910B/C16...

16 chiavi a bussola poligonali
e 5 accessori

38"



910B/C16 1 009100937

	○ 910B	6 - 7 - 8 - 9 - 10 - 11 - 12 - 13 14 - 15 - 16 - 17 - 18 - 19 21 - 22 mm
	910/21	125 mm
	910/22	250 mm
	910/25	
	910/42	
	910/55	

≡ 335x145x60 mm - 2,3 kg

910B/C16Q 1 009100933

	○ 910B	6 - 7 - 8 - 9 - 10 - 11 - 12 - 13 14 - 15 - 16 - 17 - 18 - 19 21 - 22 mm
	910/21	125 mm
	910/22	250 mm
	910/25	
	910/42	
	910/55Q	

≡ 335x145x60 mm - 2,3 kg

910A/C17

17 chiavi a bussola esagonali
e 9 accessori

38"



910A/C17 1 009100938

	○ 910A	6 - 7 - 8 - 9 - 10 - 11 - 12 - 13 14 - 15 - 16 - 17 - 18 - 19 - 20 21 - 22 mm
	910/15	□ 3/8 - ■ 1/4
	910/16	□ 3/8 - ■ 1/2
	910/21	125 mm
	910/22	250 mm
	910/25	
	910/36A	
	910/42	
	910/46	
	910/55	

≡ 420x280x60 mm - 4,0 kg

910.../C29

17 chiavi a bussola
12 a giravite e 5 accessori

38"



910A/C29 1 009100944

	○ 910A	6 - 7 - 8 - 9 - 10 - 11 - 12 - 13 14 - 15 - 16 - 17 - 18 - 19 - 20 21 - 22 mm
	910LP	1x5,5 - 1,2x6,5 - 1,2x8 mm
	910PH	PH1 - PH2 - PH3
	910PE	3 - 4 - 5 - 6 - 8 - 10 mm
	910/21	125 mm
	910/22	250 mm
	910/25	
	910/42	
	910/55	

≡ 420x185x60 mm - 3,5 kg

910B/C29 1 009100945

	○ 910B	6 - 7 - 8 - 9 - 10 - 11 - 12 - 13 14 - 15 - 16 - 17 - 18 - 19 - 20 21 - 22 mm
	910LP	1x5,5 - 1,2x6,5 - 1,2x8 mm
	910PH	PH1 - PH2 - PH3
	910PE	3 - 4 - 5 - 6 - 8 - 10 mm
	910/21	125 mm
	910/22	250 mm
	910/25	
	910/42	
	910/55	

≡ 420x185x60 mm - 3,5 kg

910AS/C13...

13 chiavi a bussola poligonali
e 5 accessori

38"



910AS/C13 1 009100925

	○ 910AS	1/4 - 5/16 - 11/32 - 3/8 - 7/16 1/2 - 9/16 - 19/32 - 5/8 - 11/16 3/4 - 13/16 - 7/8
	910/21	125 mm
	910/22	250 mm
	910/25	
	910/55	

≡ 335x145x60 mm - 2,3 kg

910AS/MBM-C18

13 chiavi a bussola poligonali
e 5 accessori
per manutenzioni aeronautiche

38"



910AS/MBM-C18 1 009100926

	○ 910AS	1/4 - 5/16 - 11/32 - 3/8 - 7/16 1/2 - 9/16 - 19/32 - 5/8 - 11/16 3/4 - 13/16 - 7/8
	910/21	125 mm
	910/22	250 mm
	910/25	
	910/42	
	910M/55	

≡ 335x145x60 mm - 2,5 kg

910A/C16HR

16 chiavi a bussola
esagonali e 5 accessori

• cricchetto con impugnatura rotante

38"



910A/C16HR 1 009100935

	○ 910A	6 - 7 - 8 - 9 - 10 - 11 - 12 - 13 14 - 15 - 16 - 17 - 18 - 19 21 - 22 mm
	910/21	125 mm
	910/22	250 mm
	910/25	
	910/42	
	910/58	

≡ 335x145x60 mm - 2,4 kg

920A

chiavi a bussola a mano
bocca esagonale

12"



UNI/ISO 2725 DIN 3124

Ø	mm	L	mm	Ø1	mm
8	12,4	38	21,7	10	009200008
9	13,5	38	21,7	10	009200009
10	14,9	38	21,7	10	009200010
11	16,1	38	21,7	10	009200011

mm	Ø	L	Ø1		
12	17,5	38	21,7	10	009200012
13	18,7	38	21,7	10	009200013
14	20,1	38	21,7	10	009200014
15	21,5	38	22,5	10	009200015
16	22,7	38	23,7	10	009200016
17	24,1	38	23,1	10	009200017
18	25,3	39	24,0	10	009200018
19	26,6	39	24,0	10	009200019
20	27,8	40	25,0	5	009200020
21	28,8	40	25,0	5	009200021
22	29,9	41	26,0	5	009200022
23	30,8	42	26,0	5	009200023
24	32,2	43	27,0	5	009200024
25	33,2	44	27,0	5	009200025
26	34,7	45	28,0	5	009200026
27	36,2	46	29,0	5	009200027
28	37,2	47	30,0	5	009200028
29	38,6	48	31,0	5	009200029
30	40,2	48	32,0	5	009200030
32	42,3	49	34,0	5	009200032



920A/SB13
10-11-12-13-14-15-16
17-18-19-20-21-22 mm



920A/SB8
23-24-25-26-27-28-30-32 mm

920B

chiavi a bussola a mano
bocca poligonale

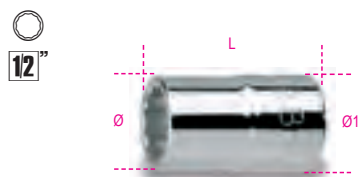

UNI/ISO 2725 DIN 3124

mm	Ø	L	Ø1		
8	12,4	38	21,7	10	009200108
9	13,5	38	21,7	10	009200109
10	14,9	38	21,7	10	009200110
11	16,1	38	21,7	10	009200111
12	17,5	38	21,7	10	009200112
13	18,7	38	21,7	10	009200113
14	20,1	38	21,7	10	009200114
15	21,5	38	22,5	10	009200115
16	22,7	38	23,7	10	009200116
17	24,1	38	23,1	10	009200117
18	25,3	39	24,0	10	009200118
19	26,6	39	24,0	10	009200119
20	27,8	40	25,0	5	009200120
21	28,8	40	25,0	5	009200121
22	29,9	41	26,0	5	009200122
23	30,8	42	26,0	5	009200123
24	32,2	43	27,0	5	009200124
25	33,2	44	27,0	5	009200125
26	34,7	45	28,0	5	009200126
27	36,2	46	29,0	5	009200127
28	37,2	47	30,0	5	009200128
29	38,6	48	31,0	5	009200129
30	40,2	48	32,0	5	009200130
32	42,3	49	33,9	5	009200132



920B/SB13
10-11-12-13-14-15-16
17-18-19-20-21-22 mm



920B/SB8
23-24-25-26-27
28-30-32 mm

920AL

chiavi a bussola a mano lunghe
bocca esagonale



UNI/ISO 2725 DIN 3124

mm	Ø	L	Ø1		
10	14,7	77	21	5	009200626
12	17,8	77	21	5	009200627
13	19,0	77	22	5	009200628
14	20,3	77	22	5	009200629
15	21,5	77	22	5	009200630
16	22,8	77	22	5	009200631
17	24,0	77	23	5	009200632
18	25,0	77	24	5	009200633
19	26,5	77	25	5	009200634
21	29,0	77	27	5	009200635
22	30,0	77	28	5	009200636
23	31,5	77	29	5	009200637
24	32,8	77	30	5	009200638
27	36,5	77	33	3	009200639
30	40,0	77	36	3	009200640
32	42,8	77	38	3	009200641
36	48,0	77	41	3	009200642



920AL/SB11
10-12-13-14-15-16
17-18-19-21-22 mm

920BL

chiavi a bussola a mano lunghe
bocca poligonale

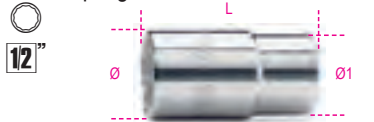

UNI/ISO 2725 DIN 3124

mm	Ø	L	Ø1		
10	14,7	77	21	5	009200310
12	17,8	77	21	5	009200312
13	19,0	77	22	5	009200313
14	20,3	77	22	5	009200314
15	21,5	77	22	5	009200315
16	22,8	77	22	5	009200316
17	24,0	77	23	5	009200317
18	25,0	77	24	5	009200318
19	26,5	77	25	5	009200319
21	29,0	77	27	5	009200321
22	30,0	77	28	5	009200322
23	31,5	77	29	5	009200323
24	32,8	77	30	5	009200324
27	36,5	77	33	3	009200327
30	40,0	77	36	3	009200330
32	42,8	77	38	3	009200332
36	48,0	77	41	3	009200336



920BL/SB11
10-12-13-14-15-16-17-18
19-21-22 mm

920A/AS

chiavi a bussola a mano
bocca esagonale

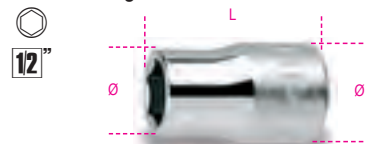

"	Ø	L	Ø1		
3/8	14,6	37	21	2	009200270
7/16	16,5	37	21	3	009200272
1/2	19,0	37	22	3	009200273
9/16	20,3	37	22	3	009200274
5/8	22,8	37	22	3	009200276
11/16	25,0	37	24	3	009200277
3/4	26,5	38	25	3	009200279
13/16	29,0	38	27	3	009200281
7/8	30,0	40	28	3	009200282
15/16	32,8	42	30	3	009200284
1	35,0	42	32	3	009200285
1.1/16	36,5	43	33	2	009200287
1.1/8	39,0	43	35	2	009200289
1.1/4	42,8	46	38	2	009200292



920A-AS/SB11
3/8-7/16-1/2-9/16-5/8
11/16-3/4-13/16-7/8
15/16-1

920AS

chiavi a bussola a mano
bocca poligonale

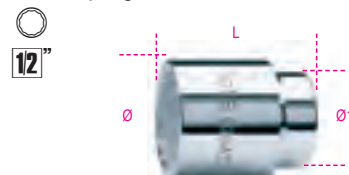

"	Ø	L	Ø1		
3/8	14,9	38	21,7	3	009200201
7/16	16,1	38	21,7	3	009200202
1/2	18,7	38	21,7	3	009200203
9/16	20,1	38	21,7	3	009200204
5/8	22,7	38	22,5	3	009200206
19/32	21,5	38	23,7	3	009200207
11/16	25,3	39	24,0	3	009200208
3/4	26,6	39	24,0	3	009200209
25/32	27,8	40	25,0	3	009200210
13/16	28,8	40	25,0	3	009200211
7/8	29,9	41	26,0	3	009200212
15/16	32,2	43	27,0	3	009200214
1	34,2	45	28,0	3	009200216
1.1/16	36,2	46	29,0	2	009200217
1.1/8	38,6	48	31,0	2	009200218
1.3/16	40,2	48	32,0	2	009200219
1.1/4	42,3	49	33,5	2	009200220



920AS/SB11
3/8-7/16-1/2-9/16-5/8
11/16-3/4-13/16-7/8
15/16-1

920AS/L

chiavi a bussola a mano lunghe
bocca poligonale



"	Ø mm	L mm	Ø1 mm		
1/2	19,0	77	22	2	009200352
9/16	20,3	77	22	2	009200353
5/8	22,8	77	22	2	009200355
11/16	25,0	77	24	2	009200357
3/4	26,5	77	25	2	009200358
13/16	29,0	77	27	2	009200360
7/8	30,0	77	28	2	009200361
15/16	32,8	77	30	2	009200362
1	35,0	77	32	2	009200363
1.1/16	36,5	77	33,0	2	009200364
1.1/8	37,8	77	34	2	009200365



920ASL/SB11
1/2-9/16-5/8-11/16
3/4-13/16-7/8-15/16
1-1.1/8-1.1/16
1 009200369

920FTX

chiavi a bussola a mano per viti
con testa a profilo Torx®

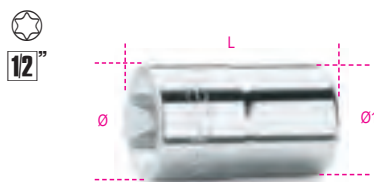

"	Ø mm	L mm	Ø1 mm		
E10	13,2	36	21	5	009200380
E12	15,0	37	21	5	009200381
E14	16,3	37	21	5	009200382
E16	18,8	37	22	5	009200383
E18	20,4	37	22	5	009200384
E20	22,9	37	22	5	009200385
E22	25,0	37	24	3	009200387
E24	26,5	40	25	3	009200388



920FTX/SB6
E10-E12-E14
E16-E18-E20
1 009200390



920FTX/C8
E10-E12-E14-E16
E18-E20-E22-E24
1 009200391

270X120X45 mm - 1 kg

920FTX/L

chiavi a bussola a mano lunghe
per viti con testa a profilo Torx®



"	Ø mm	L mm	Ø1 mm		
E10	13,2	77	21,0	5	009200400
E12	15,0	77	21,0	5	009200401
E14	16,3	77	21,0	5	009200402
E16	18,8	77	21,8	3	009200403
E18	20,4	77	21,8	3	009200404
E20	22,9	77	22,0	3	009200405



920FTX/LSB6
E10-E12-E14
E16-E18-E20
1 009200409

920LP

chiavi a bussola a giravite
per viti con intaglio

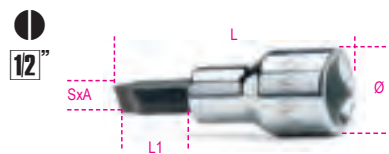

SxA mm	Ø mm	L mm	L1 mm		
1x5,5	22,5	62	24	3	009200452
1,2x6,5	22,5	62	24	3	009200453
1,2x8	22,5	62	24	3	009200454
1,6x9	22,5	62	24	3	009200456
2x12	22,5	62	24	3	009200458

920PH

chiavi a bussola a giravite
per viti con impronta a croce Phillips®



PH	Ø mm	L mm	L1 mm		
1	22,5	56	18	3	009200471
2	22,5	56	18	3	009200472
3	22,5	56	18	3	009200473
4	22,5	56	18	3	009200474

920LH/SB7

chiavi a bussola a giravite
per viti con impronta a croce Phillips®



920LH/SB7
920LP 1,2x6,5 - 1,2x8
1,6x9 - 2x12 mm
920PH PH2 - PH3 - PH4
1 009200478

920PE

chiavi a bussola
maschio esagonale



DIN 7422

mm	Ø mm	L mm	L1 mm		
3	22,5	58	20	5	009200410
4	22,5	58	20	5	009200412
5	22,5	58	20	5	009200414
5L	22,5	100	62	5	009200415
6	22,5	58	20	5	009200417
6L	22,5	100	62	5	009200418
7	22,5	58	20	5	009200420
7L	22,5	100	62	5	009200421
8	22,5	58	20	5	009200423
8L	22,5	100	62	5	009200424
9	22,5	58	20	5	009200425
9L	22,5	140	102	5	009200426
10	22,5	58	20	5	009200428
10L	22,5	140	102	5	009200429
12	23,0	58	20	5	009200432
12L	22,5	140	102	5	009200433
14	23,0	58	20	5	009200434
14L	22,5	140	102	5	009200435
17	29,5	60	22	5	009200437
19	29,5	60	22	5	009200439



920PE/SB9
4-5-6-8-10 mm
5L-6L-8L-10L mm
1 009200441



920PE/C10
4-5-6-7-8-10
12-14-17-19 mm
1 009200443

270X120X45 mm - 1,5 kg

Beta

920PE/AS

chiavi a bussola
maschio esagonale



"	Ø mm	L mm	L1 mm	
1/8	22,5	58	20	2 009200460
3/16	22,5	58	20	2 009200461
1/4	22,5	58	20	2 009200463
3/8	22,5	58	20	2 009200464
1/2	22,5	60	20	2 009200465
3/4	22,5	60	20	1 009200468

920BP

chiavi a bussola maschio esagonale
con estremità sferica

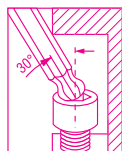
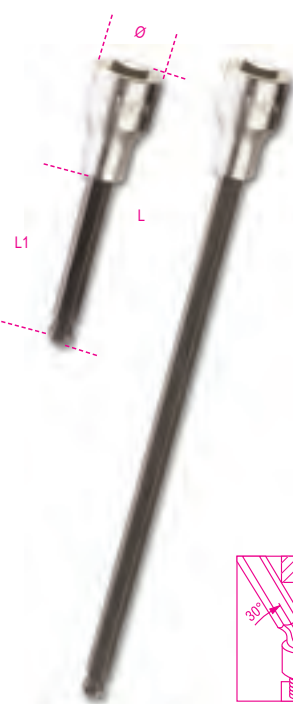

mm	Ø mm	L mm	L1 mm	
5L	22,5	100	62	5 009200490
5XL	22,5	240	202	1 009200495
6L	22,5	100	62	5 009200491
6XL	22,5	240	202	1 009200496
7L	22,5	100	62	5 009200492
8L	22,5	100	62	5 009200493
8XL	22,5	240	202	1 009200497
10L	22,5	140	102	5 009200494



920BP/SB8	1 009200500
5L-6L-7L-8L-10L mm	
5XL-6XL-8XL mm	

920ME

chiavi a bussola
maschio esagonale



mm	Ø mm	L mm	L1 mm	
5	21	75	15,5	5 009200505
6	21	75	15,5	5 009200506
7	21	75	15,5	5 009200507
8	21	75	15,5	5 009200508
10	23	75	15,5	5 009200510
12	24	75	15,5	5 009200512
14	24	75	15,5	5 009200514
17	24	75	15,5	5 009200517



920ME/SB7	1 009200519
5-6-8-10-12-14-17 mm	



920ME/C7	1 009200518
5-6-8-10-12-14-17 mm	
250X100X35 mm - 1,4 kg	

920TX

chiavi a bussola maschio
per viti con impronta Torx®



mm	Ø mm	L mm	L1 mm	
T20	22,5	58	20	5 009200520
T20L	22,5	120	82	3 009200530
T25	22,5	58	20	5 009200521
T25L	22,5	120	82	3 009200531
T27	22,5	58	20	5 009200522
T27L	22,5	120	82	3 009200533
T30	22,5	58	20	5 009200523
T30L	22,5	120	82	3 009200534
T40	22,5	58	20	5 009200524
T40L	22,5	120	82	3 009200535
T45	22,5	58	20	5 009200525
T45L	22,5	120	82	3 009200537
T50	22,5	58	20	5 009200526
T50L	23,0	140	102	3 009200538
T55	23,0	58	20	3 009200527
T55L	23,0	140	102	3 009200539
T60	23,0	58	20	3 009200528
T60L	23,0	140	102	3 009200540
T70L	23,0	120	82	3 009200541



920TX/SB9	1 009200532
T20-T25-T27-T30	
T40-T45-T50-T55-T60	



920TX/L-SB10	1 009200545
T20L-T25L-T27L-T30L-T40L-	
T45L-T50L-T55L-T60L-T70L	



920TX/C9	1 009200546
T20-T25-T27-T30-T40	
T45-T50-T55-T60	

270X120X45 mm - 1,2 kg

920RTX

chiavi a bussola maschio per viti
con impronta Tamper Resistant Torx®



mm	Ø mm	L mm	L1 mm	
T20	22,5	58	20	5 009200370
T25	22,5	58	20	5 009200371
T27	22,5	58	20	5 009200372
T30	22,5	58	20	5 009200373
T40	22,5	58	20	5 009200374



920RTX/SB5	1 009200378
T20-T25-T27-T30-T40	

920XZN

chiavi a bussola maschio
a profilo XZN®

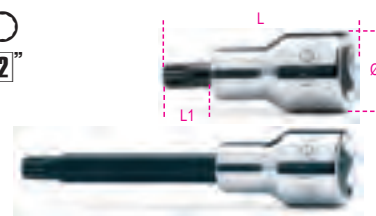

DIN 2324

mm	Ø mm	L mm	L1 mm	
M4	22,5	58	20	3 009200559
M5	22,5	58	20	3 009200560
M6	22,5	58	20	3 009200561
M6L	22,5	100	62	3 009200562
M8	22,5	58	20	3 009200563
M8L	22,5	100	62	3 009200564
M9	22,5	58	20	3 009200582
M9L	22,5	100	62	3 009200583
M10	22,5	58	20	3 009200565
M10L	22,5	100	62	3 009200566
M12	22,5	58	20	3 009200568
M12L	22,5	100	62	3 009200569

Ø	L	L1		
mm	mm	mm		
M14	23,0	58	3	009200571
M14L	23,0	100	3	009200572
M16	23,0	58	3	009200573
M18	23,0	58	3	009200574



920XZN/SB7
M4-M5-M6-M8
M10-M12-M14



920XZN/SB12
M5-M6-M8-M10-M12
M14-M16-M6L-M8L
M10L-M12L-M14L



920XZN/LS5
M6L-M8L-M10L
M12L-M14L

920ES

chiavi a bussola per viti con impronta esascalanata



UNI 9326

Ø	L	L1		
mm	mm	mm		
7	(6R)	58	5	009200587
7XL	(6R)	240	1	009200607
9	(8R)	58	5	009200589
9XL	(8R)	240	1	009200609
10	(8S)	58	5	009200590
10XL	(8S)	240	1	009200610
11	(10R)	58	5	009200591
11XL	(10R)	240	1	009200611
12L	(10S)	100	3	009200592
12XL	(10S)	240	1	009200612
14L	(12S)	100	3	009200594
14XL	(12S)	240	1	009200614
16L	(14R)	100	3	009200596
16XL	(14R)	240	1	009200616



920ES/SB7
7-9-10-11-12L-14L-16L



920ES/XL-SB7
7XL-9XL-10XL-11XL
12XL-14XL-16XL

920/15

raccordo con attacco quadro femmina 1/2" e maschio 3/8"



UNI/ISO 3316 DIN 3123

L	□	■	Ø		
mm			mm		
42	1/2	3/8	22,0	5	009200810



E' assolutamente necessario commisurare la coppia di serraggio alla capacità del quadro maschio per evitare rotture o danni accidentali

920/16

raccordo con attacco quadro femmina 1/2" e maschio 3/4"



UNI/ISO 3316 DIN 3123

L	□	■	Ø		
mm			mm		
46	1/2	3/4	26	5	009200814

920/20 - 920/21 - 920/22

prolunghe con attacchi quadri maschio e femmina 1/2"



UNI/ISO 3316 DIN 3123

	L	Ø		
	mm	mm		
920/20	75	22	5	009200818
920/21	125	22	5	009200822
920/22	255	22	5	009200826

920AN

prolunghe con attacchi quadri maschio e femmina 1/2" angolari

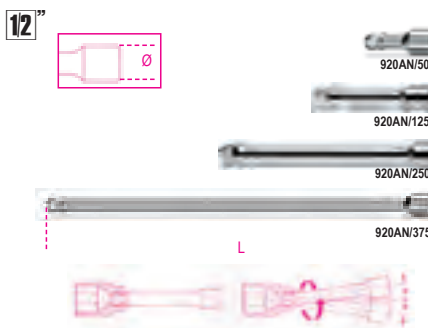

	L	Ø		
	mm	mm		
920AN/50	50	22	5	009200833
920AN/125	125	22	5	009200834
920AN/250	250	22	3	009200835
920AN/375	375	22	3	009200836

920/25

snodo con attacchi quadri maschio e femmina 1/2"



UNI/ISO 3316 DIN 3123

L	Ø		
mm	mm		
75	27	5	009200830

920/35A

quadro maschio 1/2" snodato con impugnatura



UNI/ISO 3315 DIN 3122

L	L1		
mm	mm		
285	160	3	009200846

920M/35

quadro maschio 1/2" snodato con impugnatura in metallo



UNI/ISO 3315 DIN 3122

L			
mm			
380	2	009200845	

920M/35L

quadro maschio 1/2" snodato con impugnatura in metallo, lungo



L			
mm			
600	1	009200843	



È assolutamente necessario applicare il carico di torsione adeguatamente e progressivamente per evitare rotture o danni accidentali.

920/36A

quadro maschio 1/2" snodato con impugnatura



UNI/ISO 3315 DIN 3122

L	L1		
mm	mm		
408	283	2	009200847

920/40

quadro maschio 1/2"
snodato a T



L	L1	
mm	mm	
490	230	2 009200850

920/42

quadro maschio 1/2"
con spina scorrevole

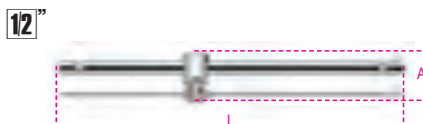

UNI/ISO 3315 DIN 3122

L	A	
mm	mm	
305	42	5 009200854

920/44

quadro maschio 1/2"
ad angolo



UNI/ISO 3315 DIN 3122

L	L1	
mm	mm	
230	60	3 009200858

920/46

quadro maschio 1/2"
con manovella

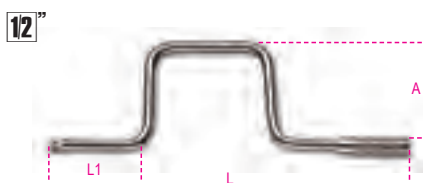

UNI/ISO 3315 DIN 3122

L	L1	A	
mm	mm	mm	
385	110	160	1 009200862

920/50

cricchetto semplice
con attacco quadro scorrevole 1/2"
meccanismo a 72 denti



UNI/ISO 3315 DIN 3122

L	Ø	A	
mm	mm	mm	
275	40	42	3 009200871

920/50F

cricchetto semplice
con attacco quadro femmina 1/2"
meccanismo a 72 denti



UNI/ISO 3315 DIN 3122

L	Ø	A	
mm	mm	mm	
275	40	27	2 009200889

920/55

cricchetto reversibile
con attacco quadro maschio 1/2"
meccanismo a 72 denti



UNI/ISO 3315 DIN 3122

L	Ø	A	
mm	mm	mm	
275	40	43	3 009200882

920/55Q

cricchetto reversibile
con attacco quadro maschio 1/2"
meccanismo a 48 denti



UNI/ISO 3315 DIN 3122

L	Ø	A	
mm	mm	mm	
275	40	43	3 009200885

920/55X

cricchetto reversibile
con attacco quadro maschio 1/2"
meccanismo a 72 denti



UNI/ISO 3315 DIN 3122

L	Ø	A	
mm	mm	mm	
200	30	33	3 009200895

920/55LC

cricchetto reversibile
con attacco quadro maschio 1/2"
"Locking System"
meccanismo a 72 denti



UNI/ISO 3315 DIN 3122

L	Ø	A	
mm	mm	mm	
275	40	43	2 009200896

920M/55

cricchetto reversibile
con attacco quadro maschio 1/2"
con impugnatura in metallo



L	Ø	A	
mm	mm	mm	
253	38	35	1 009200893

920/56A

cricchetto reversibile snodato
con attacco quadro maschio 1/2"
meccanismo a 72 denti



L	Ø	A	
mm	mm	mm	
315	40	43	1 009200911

920M/56

cricchetto reversibile snodato
con attacco quadro maschio 1/2"
con impugnatura in metallo



L	Ø	A	
mm	mm	mm	
330	38	35,7	2 009200894

920/58

cricchetto reversibile
con impugnatura rotante
con attacco quadro maschio 1/2"
meccanismo a 52 denti

- Pulsante di rilascio della bussola
- Sistema di inversione a ghiera sulla testa del cricchetto
- Impugnatura bimateriale

12"



L mm	Ø mm	A mm	1	009200926
281	42,5	45		

**Meccanismi rotanti
di ricambio dei cricchetti,
vedi tabella dopo l'art. 929/C8**

920.../C11

11 chiavi a bussola
e 2 accessori

12"



920A/C11 1 009200921

○ 920A	10 - 12 - 13 - 14 - 15 - 16 17 - 18 - 19 - 21 - 22 mm
920/22	255 mm
920/50	
≡ 335x145x60 mm - 2,5 kg	

920B/C11 1 009200922

○ 920B	10 - 12 - 13 - 14 - 15 - 16 17 - 18 - 19 - 21 - 22 mm
920/22	255 mm
920/50	
≡ 335x145x60 mm - 2,5 kg	

920.../C12...

12 chiavi a bussola
e 5 accessori

12"



920A/C12X 1 009200933

○ 920A	10 - 11 - 12 - 13 - 14 - 17 - 19 22 - 24 - 27 - 30 - 32 mm
920/21	125 mm
920/22	255 mm
920/25	
920/42	
920/55	
≡ 420x185x60 mm - 4,2 kg	

920A/C12 1 009200931

○ 920A	10 - 11 - 12 - 13 - 14 - 17 - 19 22 - 24 - 27 - 30 - 32 mm
920/21	125 mm
920/22	255 mm
920/25	
920/42	
920/50	
≡ 420x185x60 mm - 4,2 kg	

920B/C12X 1 009200934

○ 920B	10 - 11 - 12 - 13 - 14 - 17 - 19 22 - 24 - 27 - 30 - 32 mm
920/21	125 mm
920/22	255 mm
920/25	
920/42	
920/55	
≡ 420x185x60 mm - 4,0 kg	

920B/C12 1 009200932

○ 920B	10 - 11 - 12 - 13 - 14 - 17 - 19 22 - 24 - 27 - 30 - 32 mm
920/21	125 mm
920/22	255 mm
920/25	
920/42	
920/50	
≡ 420x185x60 mm - 4,0 kg	

920.../C20...

20 chiavi a bussola
e 5 accessori

12"



920A/C20X 1 009200950

○ 920A	10 - 11 - 12 - 13 - 14 - 15 - 16 17 - 18 - 19 - 20 - 21 - 22 - 23 24 - 26 - 27 - 28 - 30 - 32 mm
920/21	125 mm
920/22	255 mm
920/25	
920/42	
920/55	
≡ 420x185x60 mm - 5,1 kg	

920A/C20 1 009200948

○ 920A	10 - 11 - 12 - 13 - 14 - 15 - 16 17 - 18 - 19 - 20 - 21 - 22 - 23 24 - 26 - 27 - 28 - 30 - 32 mm
920/21	125 mm
920/22	255 mm
920/25	
920/42	
920/50	
≡ 420x185x60 mm - 5,1 kg	

920A/C20Q 1 009200955

○ 920A	10 - 11 - 12 - 13 - 14 - 15 - 16 17 - 18 - 19 - 20 - 21 - 22 - 23 24 - 26 - 27 - 28 - 30 - 32 mm
920/21	125 mm
920/22	255 mm
920/25	
920/42	
920/55Q	
≡ 420x185x60 mm - 5,1 kg	

Beta

920.../C20...

20 chiavi a bussola
e 5 accessori

12"



920B/C20

1 009200949

	○ 920B	10 - 11 - 12 - 13 - 14 - 15 - 16 17 - 18 - 19 - 20 - 21 - 22 - 23 24 - 26 - 27 - 28 - 30 - 32 mm
	920/21	125 mm
	920/22	255 mm
	920/25	
	920/42	
	920/50	
420x185x60 mm - 5,1 kg		

920B/C20X

1 009200951

	○ 920B	10 - 11 - 12 - 13 - 14 - 15 - 16 17 - 18 - 19 - 20 - 21 - 22 - 23 24 - 26 - 27 - 28 - 30 - 32 mm
	920/21	125 mm
	920/22	255 mm
	920/25	
	920/42	
	920/55	
420x185x60 mm - 5,0 kg		

920.../C21...

21 chiavi a bussola
e 6 accessori

12"



920A/C21

1 009200952

	○ 920A	10 - 11 - 12 - 13 - 14 - 15 - 16 17 - 18 - 19 - 20 - 21 - 22 - 23 24 - 25 - 26 - 27 - 28 - 30 - 32 mm
	920/21	125 mm
	920/22	255 mm
	920/25	
	920/42	
	920/46	
	920/50	
420x280x60 mm - 6,5 kg		

920A/C21X

1 009200983

	○ 920A	10 - 11 - 12 - 13 - 14 - 15 - 16 17 - 18 - 19 - 20 - 21 - 22 - 23 24 - 25 - 26 - 27 - 28 - 30 - 32 mm
	920/21	125 mm
	920/22	255 mm
	920/25	
	920/42	
	920/46	
	920/55	
420x280x60 mm - 6,4 kg		

920B/C21

1 009200953

	○ 920B	10 - 11 - 12 - 13 - 14 - 15 - 16 17 - 18 - 19 - 20 - 21 - 22 - 23 24 - 25 - 26 - 27 - 28 - 30 - 32 mm
	920/21	125 mm
	920/22	255 mm
	920/25	
	920/42	
	920/46	
	920/50	
420x280x60 mm - 6,4 kg		

920B/C21X

1 009200984

	○ 920B	10 - 11 - 12 - 13 - 14 - 15 - 16 17 - 18 - 19 - 20 - 21 - 22 - 23 24 - 25 - 26 - 27 - 28 - 30 - 32 mm
	920/21	125 mm
	920/22	255 mm
	920/25	
	920/42	
	920/46	
	920/55	
420x280x60 mm - 6,4 kg		

920B/C30Q

30 chiavi a bussola poligonali
e 5 accessori

12"



920B/C30Q

1 009200975

	○ 920B	8 - 9 - 10 - 11 - 12 - 13 - 14 15 - 16 - 17 - 18 - 19 - 20 - 21 22 - 23 - 24 - 26 - 27 - 30 mm
	○ 920BL	12 - 13 - 14 - 17 - 19 - 21 22 - 24 - 27 - 30 mm
	920/21	125 mm
	920/22	255 mm
	920/25	
	920/42	
	920/55Q	
420x280x60 mm - 7,6 kg		

920.../C33

20 chiavi a bussola
13 a giravite e 5 accessori

12"











920A/C33

1 009200985

	○ 920A	10 - 11 - 12 - 13 - 14 - 15 - 16 17 - 18 - 19 - 20 - 21 - 22 - 23 24 - 26 - 27 - 28 - 30 - 32 mm
	● 920LP	1,2x8 - 1,6x9 - 2x12 mm
	⊕ 920PH	PH2 - PH3 - PH4
	○ 920PE	4 - 5 - 6 - 8 - 10 - 12 - 14 mm
	920/21	125 mm
	920/22	255 mm
	920/25	
	920/42	
	920/55	
420x280x60 mm - 6,7 kg		

920B/C33 1 009200986

-  ○ 920B 10 - 11 - 12 - 13 - 14 - 15 - 16
17 - 18 - 19 - 20 - 21 - 22 - 23
24 - 26 - 27 - 28 - 30 - 32 mm
-  ● 920LP 1,2x8 - 1,6x9 - 2x12 mm
-  ⊕ 920PH PH2 - PH3 - PH4
-  ○ 920PE 4 - 5 - 6 - 8 - 10 - 12 - 14 mm
-  920/21 125 mm
-  920/22 255 mm
-  920/25
-  920/42
-  ● 920/55

≡ 420x280x60 mm -  6,7 kg

920/C37

37 chiavi a bussola poligonali
e 5 accessori

12"



920/C37 1 009200988

-  ○ 920B 10 - 11 - 12 - 13 - 14 - 15 - 16
17 - 18 - 19 - 20 - 21 - 22 - 23
24 - 26 - 27 - 28 - 30 - 32 mm
-  ○ 920AS 3/8 - 7/16 - 1/2 - 9/16 - 19/32
5/8 - 11/16 - 3/4 - 25/32 - 13/16
7/8 - 15/16 - 1 - 1.1/16 - 1.1/8
1.3/16 - 1.1/4
-  920/21 125 mm
-  920/22 255 mm
-  920/25
-  920/42
-  ● 920/55

≡ 420x280x60 mm -  7,5 kg



920AS/C10

10 chiavi a bussola poligonali
e 2 accessori

12"



920AS/C10 1 009200919

-  ○ 920AS 3/8 - 7/16 - 1/2 - 9/16 - 5/8
11/16 - 3/4 - 13/16 - 7/8 - 15/16
-  920/22 255 mm
-  ● 920/50

≡ 335x145x60 mm -  2,6 kg

920AS/C15

15 chiavi a bussola poligonali
e 6 accessori

12"



920AS/C15 1 009200947

-  ○ 920AS 3/8 - 7/16 - 1/2 - 9/16 - 5/8 - 11/16
3/4 - 13/16 - 7/8 - 15/16 - 1
1.1/16 - 1.1/8 - 1.3/16 - 1.1/4
-  920/21 125 mm
-  920/22 255 mm
-  920/25
-  920/42
-  920/46
-  ● 920/50

≡ 420x280x60 mm -  5,9 kg

920AS/C17X

17 chiavi a bussola poligonali
e 5 accessori

12"



920AS/C17X 1 009200942

-  ○ 920AS 3/8 - 7/16 - 1/2 - 9/16 - 19/32 - 5/8
11/16 - 3/4 - 25/32 - 13/16 - 7/8
15/16 - 1 - 1.1/16 - 1.1/8 - 1.3/16
- 1.1/4
-  920/21 125 mm
-  920/22 255 mm
-  920/25
-  920/42
-  ● 920/55

≡ 420x185x60 mm -  4,8 kg





920AS/MBM-C21

16 chiavi a bussola poligonali
e 5 accessori
per manutenzioni aeronautiche

12"



920AS/MBM-C21 1 009200944

-  ○ 920AS 3/8 - 7/16 - 1/2 - 9/16
19/32 - 5/8 - 11/16 - 3/4
25/32 - 13/16 - 7/8 - 15/16
1 - 1.1/16 - 1.3/16 - 1.1/4
-  920M/55
-  920/21 125 mm
-  920/22 255 mm
-  920/25
-  920/42

≡ 420x185x60 mm -  5,0 kg

920TX/C17

6 inserti per avvitatori
6 chiavi a bussola
5 chiavi a bussola maschio
e 4 accessori, per viti con impronta Torx®







12"

12"

12"



920TX/C17 1 009200989

-  ● 861TX T8 - T10 - T15 - T20 - T25 - T27
-  897
-  ● 920TX T27 - T30 - T40 - T45 - T50
-  ● 920FTX E10 - E12 - E14 - E16 - E18 - E20
-  920/20 75 mm
-  920/22 255 mm
-  ● 920/55

≡ 420x185x60 mm -  2,9 kg

920A/C17HR

17 chiavi a bussola esagonali e 5 accessori in termoformato rigido, in cassetta di lamiera

• cricchetto con impugnatura rotante

12"



920A/C17HR 1 009200939

920A	10-11-12-13-14-15-16-17-18-19-20-21-22-24-27-30-32 mm
920/21	125 mm
920/22	255 mm
920/25	
920/42	
920/58	

420x185x60 mm - 5,1 kg

928A

chiavi a bussola a mano bocca esagonale

3/4"



UNI/ISO 2725
DIN 3124

mm	Ø mm	L mm	Ø1 mm	
19	29,2	50	34	5 009280019
22	31,3	53	34	5 009280022
23	33,3	53	34	5 009280023
24	34,5	53	34	5 009280024
26	36,8	55	35	5 009280026
27	38,0	56	35	5 009280027
28	39,0	57	35	3 009280028
29	40,2	58	35	3 009280029
30	41,5	58	37	3 009280030
32	44,3	60	37	3 009280032
33	45,8	60	37	3 009280033
34	46,8	60	37	3 009280034
35	48,1	62	38	3 009280035
36	49,5	64	38	3 009280036
38	52,0	68	40	3 009280038
41	56,0	71	40	3 009280041
46	62,3	75	43	3 009280046
50	67,4	80	43	3 009280050
55	73,7	84	48	1 009280055
60	80,0	87	48	1 009280060

928B

chiavi a bussola a mano bocca poligonale

3/4"

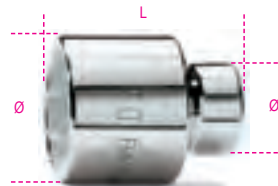

UNI/ISO 2725
DIN 3124

mm	Ø mm	L mm	Ø1 mm	
19	29,2	50	34	5 009280119
22	31,3	53	34	5 009280122
23	33,3	53	34	5 009280123
24	34,5	53	34	5 009280124
26	36,8	55	35	5 009280126
27	38,0	56	35	5 009280127
28	39,0	57	35	3 009280128
29	40,2	58	35	3 009280129
30	41,5	58	37	3 009280130
32	44,3	60	37	3 009280132
33	45,8	60	37	3 009280133
34	46,8	60	37	3 009280134
35	48,1	62	38	3 009280135
36	49,5	64	38	3 009280136
38	52,0	68	40	3 009280138
41	56,0	71	40	3 009280141
46	62,3	75	43	3 009280146
50	67,4	80	43	3 009280150
55	73,7	84	48	1 009280155
60	80,0	87	48	1 009280160

928AS

chiavi a bussola a mano bocca esagonale

3/4"

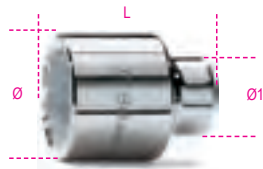

mm	Ø mm	L mm	Ø1 mm	
7/8	32,0	53	34	1 009280202
15/16	34,5	53	34	1 009280203
1	36,2	55	35	1 009280204
1.1/16	38,0	56	35	1 009280205
1.1/8	40,2	58	35	1 009280206
1.1/4	44,2	60	37	1 009280208
1.5/16	45,8	60	37	1 009280209
1.3/8	48,1	62	38	1 009280210
1.7/16	49,5	64	38	1 009280211
1.1/2	52,0	68	40	1 009280212
1.5/8	56,0	71	40	1 009280214
1.11/16	58,8	74	40	1 009280215
1.13/16	62,3	75	43	1 009280217
1.7/8	65,0	78	43	1 009280218
2	68,3	80	43	1 009280219
2.1/16	71,5	83	48	1 009280220

928ME

chiavi a bussola maschio esagonale

3/4"



mm	Ø mm	L mm	L1 mm	
14	35	75	15,5	2 009280514
17	35	75	15,5	2 009280517
19	35	75	15,5	2 009280519
22	35	75	22,5	2 009280522

928/15

raccordo con attacco quadro femmina 3/4" e maschio 1/2"

3/4"

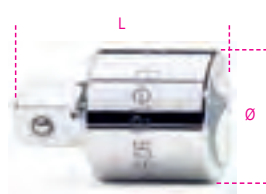

UNI/ISO 3316
DIN 3123

L mm	Ø mm	□	■	
51,5	34	3/4	1/2	5 009280801

È assolutamente necessario commisurare la coppia di serraggio alla capacità del quadro maschio per evitare rotture o danni accidentali

928/16

raccordo con attacco quadro femmina 3/4" e maschio 1"

3/4"



UNI/ISO 3316
DIN 3123

L mm	Ø mm	□	■	
65	34	3/4	1"	5 009280807

928/21 - 928/22

prolunghe con attacchi quadri maschio e femmina 3/4"

3/4"



UNI/ISO 3316
DIN 3123

	L mm	Ø mm	
928/21	200	34	3 009280815
928/22	380	34	3 009280825

928/25

snodo con attacchi quadri maschio e femmina 3/4"

3/4"



UNI/ISO 3316 DIN 3123

L mm	Ø mm	
108	40	1 009280830

928/36A

quadro maschio 3/4" snodato con impugnatura

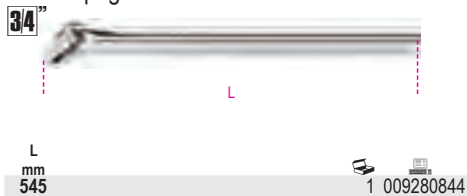

L
mm
545

1 009280844

928/42

quadro maschio 3/4" con spina scorrevole

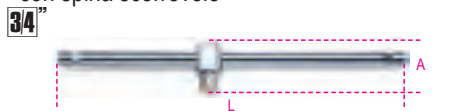

UNI/ISO 3315 DIN 3122

L mm 450 A mm 62,5

3 009280850

928/55

cricchetto reversibile con attacco quadro maschio 3/4" meccanismo a 72 denti

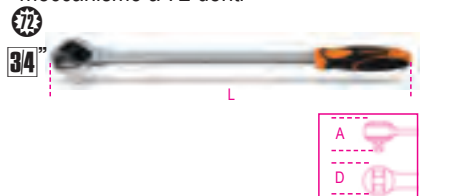

L mm 510 Ø mm 58 A mm 59

2 009280862

Meccanismi rotanti di ricambio dei cricchetti, vedi tabella dopo l'art. 929/C8

928.../C12

12 chiavi a bussola esagonali e 5 accessori in cassetta di lamiera



928A/C12 1 009280955

928A	22 - 24 - 27 - 30 - 32 - 34 - 36 38 - 41 - 46 - 50 - 55 mm
928/21	200 mm
928/22	380 mm
928/25	
928/42	
928/55	

530x220x80 mm - 13,5 kg

928B/C12 1 009280957

928B	22 - 24 - 27 - 30 - 32 - 34 - 36 38 - 41 - 46 - 50 - 55 mm
928/21	200 mm
928/22	380 mm
928/25	
928/42	
928/55	

530x220x80 mm - 13,5 kg

928AS/C12

12 chiavi a bussola esagonali e 5 accessori in cassetta di lamiera



928AS/C12 1 009280968

928AS	7/8-15/16-1.1/16-1.1/8-1.1/4 1.5/16-1.7/16-1.1/2-1.11/16 1.13/16-1.7/8-2.1/16
928/21	200 mm
928/22	380 mm
928/25	
928/42	
928/55	

530x220x80 mm - 13,5 kg

929

chiavi a bussola a mano bocca esagonale

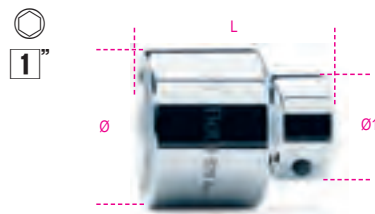

UNI/ISO 2725 DIN 3124

Ø mm	Ø mm	L mm	Ø1 mm	
36	49,5	65	48	1 009290036
41	56,0	70	48	1 009290041
46	62,0	75	48	1 009290046
50	67,5	80	48	1 009290050
55	74,0	85	54	1 009290055
60	80,0	90	54	1 009290060
65	86,0	95	54	1 009290065
70	92,0	100	60	1 009290070
75	99,0	110	60	1 009290075
80	106,0	120	60	1 009290080

929/15

raccordo con attacco quadro femmina 1" e maschio 3/4"

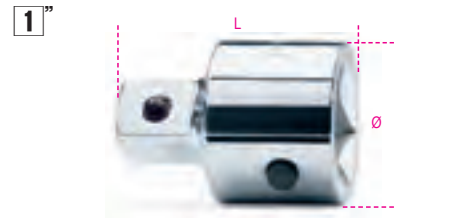

UNI/ISO 3316 DIN 3123

L mm 65 Ø mm 47 1" 3/4 2 009290801



E' assolutamente necessario commisurare la coppia di serraggio alla capacità del quadro maschio per evitare rotture o danni accidentali

929/21 - 929/22

prolunghe con attacchi quadri maschio e femmina 1"



UNI/ISO 3316 DIN 3123

	L mm	Ø mm	
929/21	200	47	1 009290815
929/22	400	47	1 009290825

929/42

quadro maschio 1" con spina scorrevole



UNI/ISO 3315 DIN 3122

L mm 535 1 009290850

929/55

cricchetto reversibile con attacco quadro maschio 1" meccanismo a 72 denti



UNI/ISO 3315 DIN 3122

L mm 770 Ø mm 62 A mm 63 1 009290860

929/C8

8 chiavi a bussola esagonali
e 5 accessori



929/C8

1 009290925

- 929 46 - 50 - 55 - 60 - 65
70 - 75 - 80 mm
- 929/15 □ 1" - ■ 3/4
- 929/21 200 mm
- 929/22 400 mm
- 929/42
- 929/55

560x290x12 mm - 29 kg

900/R55



900/R55
900/55

1 009000871

900M/R55



900M/R55
900M/55

1 009000888

910/R55



910/R55
606/6-606/10-612
666/6-666/10-910/55
599DGT/6

1 009100879

910M/R55



910M/R55
910M/55-910M/56

1 009100888

910/R55Q



910/R55Q
910/55Q

1 009100877

920/R50



920/R50
614/50-667/20-667/30
920/50

1 009200866

920/R55



920/R55
606/20-606/30-666/20-666/30
920/55-920/56A- 599DGT/20-599DGT/30

1 009200879

920M/R55



920M/R55
920M/55-920M/56

1 009200888

920/R55Q



920/R55Q
920/55Q

1 009200877

920/R55X



920/R55X
606/10X-612X
666/10X-920/55X-599DGT/10X

1 009200878

920/R55LC



920/R55LC
920/55LC "Locking System"

1 009200887

928/R55



928/R55
928/55

1 009280859

928/R55X



928/R55X
614X

1 009280858

929/R55



929/R55
929/55

1 009290859

930

chiavi a tubo doppie poligonali
serie pesante



UNI 6745

mm	L mm	Ø mm	Ø1 mm	
6x7	100	9,5	11,0	3 009300006
8x9	108	12,5	14,0	3 009300010
10x11	116	15,0	16,5	3 009300014
12x13	124	17,5	19,0	3 009300018
14x15	132	20,0	21,5	3 009300023
16x17	140	23,0	24,0	3 009300027
18x19	148	25,0	26,5	3 009300032
20x22	156	28,0	30,0	2 009300036
21x23	163	29,0	31,5	2 009300040
24x26	173	33,0	35,5	2 009300044
25x28	182	34,5	38,0	2 009300048
27x29	191	37,0	39,5	2 009300052
30x32	200	40,5	43,0	2 009300056



930/S8
6x7-8x9-10x11
12x13-14x15-16x17
18x19-20x22 mm

940/1 - /2

1 009300081

930/S13
6x7-8x9-10x11-12x13
14x15-16x17-18x19
20x22-21x23-24x26
25x28-27x29-30x32 mm

940/1 - /2 - /3

1 009300083



930/C13
6x7-8x9-10x11-12x13
14x15-16x17-18x19
20x22-21x23-24x26
25x28-27x29-30x32 mm
940/1 - /2 - /3

1 009300098

932

chiavi a pipa doppie
esagonali-poligonali
cromate lucide

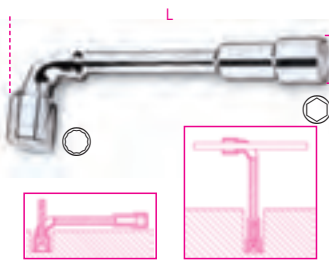

NF E 74.303

mm	Ø mm	L mm		
6x6	11,5	110	5	009320006
7x7	12,5	116	5	009320007
8x8	13,0	120	5	009320008
9x9	14,0	125	5	009320009
10x10	16,5	133	5	009320010
11x11	17,5	143	5	009320011
12x12	19,0	148	5	009320012
13x13	19,5	154	5	009320013
14x14	21,5	167	5	009320014
15x15	22,5	182	5	009320015
16x16	24,5	193	5	009320016
17x17	26,0	198	5	009320017
18x18	26,5	215	5	009320018
19x19	29,0	220	5	009320019
20x20	30,5	222	3	009320020
21x21	30,5	236	3	009320021
22x22	32,5	250	2	009320022
23x23	33,5	256	2	009320023
24x24	35,0	272	2	009320024
25x25	36,5	282	2	009320025
26x26	37,5	296	2	009320026
27x27	39,0	296	2	009320027
28x28	39,0	314	2	009320028
30x30	42,5	348	2	009320030
32x32	45,5	364	2	009320032



932/S11
6-7-8-10-11-12
13-14-17-19-22 mm
932/S17
6-7-8-9-10-11-12
13-14-15-16-17
18-19-20-21-22 mm
932/S25
6-7-8-9-10-11-12-13
14-15-16-17-18-19
20-21-22-23-24-25
26-27-28-30-32 mm

1 009320080

1 009320081

1 009320082

933

chiavi a pipa doppie
esagonali
cromate lucide

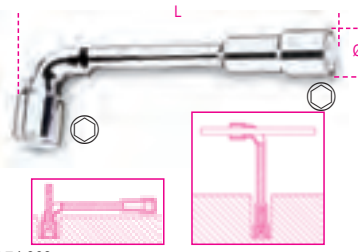

NF E 74.303

mm	Ø mm	L mm		
6x6	11,5	110	5	009330006
7x7	12,5	116	5	009330007
8x8	13,0	120	5	009330008
9x9	14,0	125	5	009330009
10x10	16,5	133	5	009330010
11x11	17,5	143	5	009330011
12x12	19,0	148	5	009330012
13x13	19,5	154	5	009330013
14x14	21,5	167	5	009330014
15x15	22,5	182	5	009330015
16x16	24,5	193	5	009330016
17x17	26,0	198	5	009330017
18x18	26,5	215	5	009330018
19x19	29,0	220	5	009330019
20x20	30,5	222	3	009330020
21x21	30,5	236	3	009330021
22x22	32,5	250	2	009330022
23x23	33,5	256	2	009330023
24x24	35,0	272	2	009330024
25x25	36,5	282	2	009330025
26x26	37,5	296	2	009330026
27x27	39,0	296	2	009330027
28x28	39,0	314	2	009330028
30x30	42,5	348	2	009330030
32x32	45,5	364	2	009330032



933/S11
6-7-8-10-11-12
13-14-17-19-22 mm
933/S17
6-7-8-9-10-11-12
13-14-15-16-17
18-19-20-21-22 mm
933/S25
6-7-8-9-10-11-12-13
14-15-16-17-18-19
20-21-22-23-24-25
26-27-28-30-32 mm

1 009330080

1 009330081

1 009330082

935

chiavi a tubo doppie
esagonali
serie leggera



UNI 6746 DIN 896

mm	L mm		
6x7	100	5	009350105
8x9	110	5	009350111
10x11	120	5	009350115
12x13	130	5	009350117
14x15	140	5	009350126
16x17	150	5	009350128
18x19	160	5	009350131
20x22	170	3	009350138
21x23	180	3	009350141
24x26	190	3	009350144
25x28	200	2	009350150
27x29	210	2	009350153
30x32	220	2	009350156

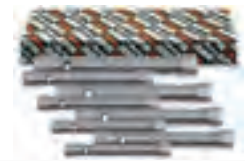

935/S8
6x7-8x9-10x11
12x13-14x15-16x17
18x19-20x22 mm

1 009350181

940/1 - /2

935/S13
6x7-8x9-10x11
12x13-14x15-16x17
18x19-20x22-21x23
24x26-25x28-27x29
30x32 mm

1 009350183

940/1 - /2 - /3

937

chiavi a pipa doppie
esagonali-poligonali
cromate

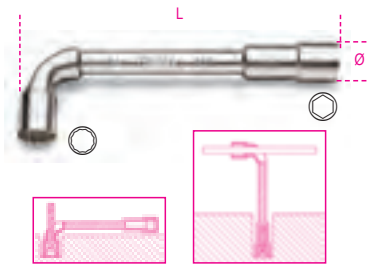

mm	Ø mm	L mm		
6x6	11,5	110	5	009370006
7x7	12,5	116	5	009370007
8x8	13,0	120	5	009370008
9x9	14,0	125	5	009370009
10x10	16,5	133	5	009370010
11x11	17,5	143	5	009370011
12x12	19,0	148	5	009370012
13x13	19,5	154	5	009370013
14x14	21,5	167	5	009370014
15x15	22,5	182	5	009370015
16x16	24,5	193	5	009370016
17x17	26,0	198	5	009370017
18x18	26,5	215	5	009370018
19x19	29,0	220	5	009370019
20x20	30,5	222	3	009370020
21x21	30,5	236	3	009370021
22x22	32,5	250	2	009370022
23x23	33,5	256	2	009370023
24x24	35,0	272	2	009370024
25x25	36,5	282	2	009370025
26x26	37,5	296	2	009370026
27x27	39,0	296	2	009370027
28x28	39,0	314	2	009370028
30x30	42,5	348	2	009370030
32x32	45,5	364	2	009370032



937/S11
6-7-8-10-11-12
13-14-17-19-22 mm

1 009370080

937/S17
6-7-8-9-10-11-12
13-14-15-16-17
18-19-20-21-22 mm

1 009370081

940

spine di manovra per 930-935



	mm	L		
	mm	mm		
940/1	6÷13	100	5	009400001
940/2	14÷22	170	5	009400002
940/3	21÷32	290	5	009400003

941

chiavi a pipa esagonali-polygonali con impugnatura di manovra

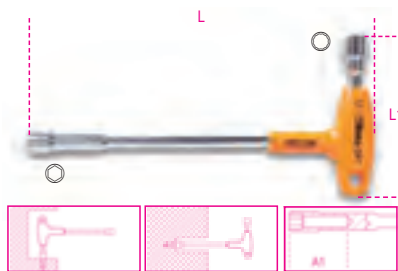

mm	L	L1	A1		
mm	mm	mm	mm		
7x7	200	91	35	2	009410107
8x8	220	107	50	2	009410108
9x9	220	109	50	2	009410109
10x10	236	111	50	2	009410110
11x11	236	114	50	2	009410111
12x12	255	122	50	2	009410112
13x13	255	124	55	2	009410113



941/S7
7-8-9-10-11-12-13 mm 1 009410170

942BX

chiavi a bussola esagonale tipo corto



UNI 6750

mm	L	L1	A1		
mm	mm	mm	mm		
4	190	70	13,0	5	009420003
5	190	70	14,0	5	009420004
5,5	190	70	12,5	5	009420005
6	190	70	14,5	5	009420006
7	190	70	15,5	5	009420007
8	202	70	18,5	5	009420008
9	202	70	19,5	5	009420009
10	202	70	20,5	3	009420010
11	202	70	21,5	3	009420011
12	202	70	22,5	3	009420012
13	202	70	23,5	3	009420013
14	202	70	24,5	3	009420014



942BX/S12
4-5-5,5-6-7-8-9
10-11-12-13-14 mm 1 009420030

943BX

chiavi a bussola esagonale tipo lungo



ISO 2236 UNI 6750

mm	L	L1	A1		
mm	mm	mm	mm		
4	270	150	13,0	5	009430003
5	270	150	14,0	5	009430004
5,5	270	150	12,5	5	009430005
6	270	150	14,5	5	009430006
7	270	150	15,5	5	009430007
8	282	150	18,5	5	009430008
9	282	150	19,5	5	009430009
10	282	150	20,5	3	009430010
11	282	150	21,5	3	009430011
12	282	150	22,5	3	009430012
13	282	150	23,5	3	009430013
14	282	150	24,5	3	009430014



943BX/S12
4-5-5,5-6-7-8-9
10-11-12-13-14 mm 1 009430030



943BX/D6
5-6-7-8-10-13 mm 1 009430026

943FL

chiavi a bussola esagonale flessibili con impugnatura

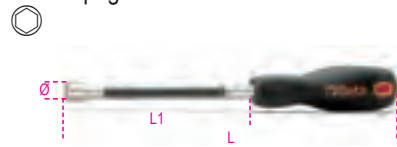

mm	L	L1	Ø		
mm	mm	mm	mm		
5	265	150	8	2	009430304
5,5	265	150	8	2	009430305
6	265	150	9	2	009430306
7	265	150	11	2	009430307
8	265	150	12	2	009430308
10	290	175	14	2	009430310



943FL/S6
5-5,5-6-7-8-10 mm 1 009430320

944BX

chiavi a bussola esagonale profonda tipo lungo



ISO 2236 UNI 6750

mm	L	L1	A1		
mm	mm	mm	mm		
4	245	125	20	3	009440003
5	245	125	25	3	009440004
5,5	245	125	30	3	009440005
6	245	125	35	3	009440006
7	245	125	35	3	009440007
8	257	125	50	3	009440008
9	257	125	50	3	009440009
10	257	125	50	3	009440010
11	257	125	50	3	009440011
12	257	125	50	3	009440012
13	257	125	55	3	009440013
14	257	125	55	3	009440014



944BX/S12
4-5-5,5-6-7-8-9
10-11-12-13-14 mm 1 009440062

 **Beta**



944BX/D6
5-6-7-8-10-13 mm

1 009440056

949

chiavi a T semplici
con bussola esagonale profonda

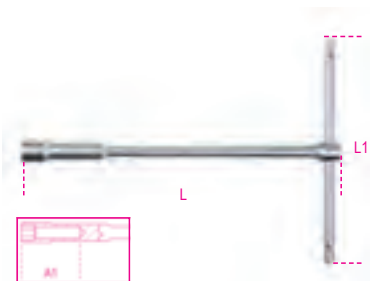

Ø mm	L mm	L1 mm	A1 mm		
8	220	160	50	2	009490008
10	230	160	50	2	009490010
12	240	175	50	2	009490012
13	244	175	55	2	009490013
14	250	190	55	2	009490014
17	264	200	60	2	009490017



949/S6
8-10-12-13-14-17mm

1 009490076

950

chiavi a T semplici
esagonali

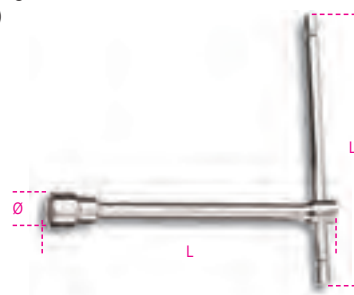

UNI 6742 DIN 3112

Ø mm	L mm	Ø mm	L1 mm		
6	210	10,1	145	3	009500006
7	212	11,2	145	3	009500007
8	220	12,4	160	3	009500008
9	223	13,5	160	3	009500009
10	230	14,9	160	3	009500010
11	233	16,1	160	3	009500011
12	240	17,5	175	3	009500012
13	244	19,7	175	3	009500013
14	250	20,1	190	3	009500014
15	254	21,5	190	3	009500015
16	260	22,7	200	3	009500016
17	264	24,1	200	3	009500017
19	274	26,6	230	3	009500019
22	290	29,9	290	2	009500022
24	300	32,2	320	2	009500024
27	315	36,2	370	2	009500027



950/S9

7-8-10-11-12
13-14-17-19 mm

1 009500079

950/S14

6-7-8-9-10-11-12-13
14-15-16-17-19-22 mm

1 009500082

951

chiavi a T con tre estremità
maschio esagonale



mm	L mm	L1 mm	Ø mm		
2	125	63	4,0	5	009510521
2,5	150	63	4,0	5	009510525
3	150	63	4,0	5	009510530
3,5	175	76	5,5	5	009510535
4	175	76	5,5	5	009510540
4,5	195	87	6,5	5	009510545
5	195	87	6,5	5	009510550
6	215	99	8,0	5	009510560
7	230	109	9,0	5	009510570
8	250	122	10,0	5	009510580
9	265	132	11,0	5	009510590
10	280	142	12,0	5	009510610
12	305	160	15,0	3	009510620
14	330	178	17,0	3	009510640

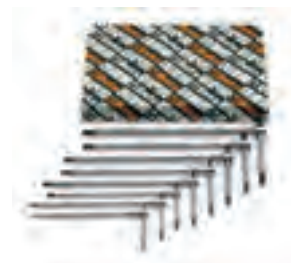

951/S8

2-2,5-3-3,5-4-4,5-5-6 mm

1 009510693

951/S14

2-2,5-3-3,5-4-4,5
5-6-7-8-9-10-12-14 mm

1 009510695



951/SP6

3-4-5-6-8-10 mm

1 009510696

951/SPV

1 009510697

951AS

chiavi a T con tre estremità
maschio esagonale



"	L mm	L1 mm	Ø mm		
3/32	125	63	4,0	2	009510750
7/64	150	63	4,0	2	009510751
1/8	150	63	4,0	2	009510752
9/64	175	76	5,5	2	009510753
5/32	175	76	5,5	2	009510754
3/16	195	86	6,5	2	009510755
7/32	215	99	8,0	2	009510757
1/4	230	109	9,0	2	009510758
5/16	250	122	10,0	2	009510759
3/8	280	142	12,0	2	009510760

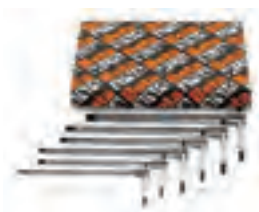

951AS/S6

5/32-3/16-7/32
1/4-5/16-3/8

1 009510770

951TX

chiavi a T con tre estremità maschio per viti con impronta Torx®



Ø	L mm	L1 mm	Ø mm	
T6	125	63	4	3 009510806
T7	125	63	4	3 009510807
T8	125	63	4	3 009510808
T9	125	63	4	3 009510809
T10	150	63	4	3 009510810
T15	150	63	4	3 009510815
T20	175	76	5	3 009510820
T25	175	76	5	3 009510825
T27	195	87	6	3 009510827
T30	195	87	6	3 009510830
T40	215	99	7	3 009510840
T45	230	109	8	3 009510845
T50	250	122	9	3 009510850

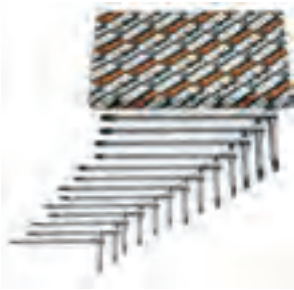

951TX/S13
T6-T7-T8-T9-T10-T15-T20-T25
T27-T30-T40-T45-T50

1 009510863

952

chiavi a T con bussola esagonale snodata

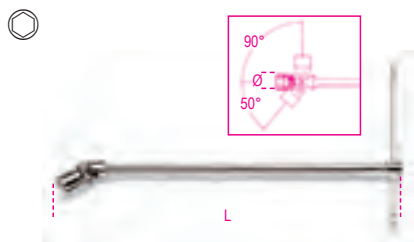

UNI 6743

Ø mm	Ø mm	L mm	
6	9,5	395	5 009520006
7	10,7	395	5 009520007
8	12,1	395	5 009520008
9	13,2	395	5 009520009
10	14,6	400	5 009520010
11	15,8	400	5 009520011
12	17,0	400	5 009520012
13	18,7	432	5 009520013
14	19,7	432	5 009520014
15	20,9	450	3 009520015
16	22,0	450	3 009520016
17	23,4	450	3 009520017
18	24,7	450	3 009520018
19	26,0	500	3 009520019
20	27,4	500	3 009520020
21	28,5	500	3 009520021
22	29,7	500	3 009520022
24	32,4	500	3 009520024



952/S7
8-10-11-13-14-17-19 mm
952/S18
6-7-8-9-10-11-12
13-14-15-16-17
18-19-20-21-22-24 mm

1 009520074

1 009520083

952AS

chiavi a T con bussola esagonale snodata

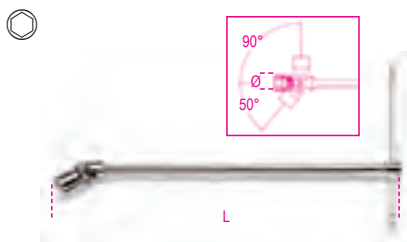

Ø "	Ø mm	L mm	
1/4	9,5	395	2 009520256
5/16	12,1	395	2 009520258
3/8	14,6	400	2 009520260
7/16	15,8	400	2 009520261
1/2	18,7	432	2 009520263
9/16	19,7	432	2 009520264
5/8	22,0	450	2 009520266
11/16	23,4	450	2 009520267
3/4	26,0	500	2 009520269

952L

chiavi a T con bussola esagonale snodata, tipo lungo

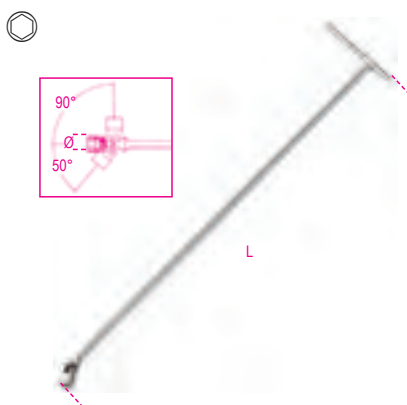

Ø mm	Ø mm	L mm	
10	14,6	930	1 009520410
12	17,0	1063	1 009520412
13	18,7	1100	1 009520413
14	19,7	1100	1 009520414
15	20,9	1100	1 009520415
16	22,0	1100	1 009520416
17	23,4	1100	1 009520417
18	24,7	1100	1 009520418
19	26,0	1100	1 009520419

952FTX

chiavi a T con bussola snodata per viti con testa a profilo Torx®

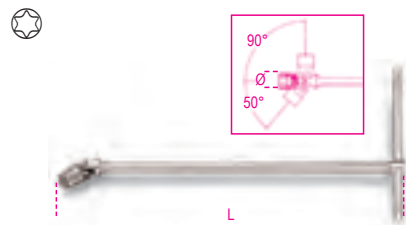

Ø mm	L mm	
E6	8	2 009520106
E7	9	2 009520107
E8	10	2 009520108
E10	13	2 009520110
E12	15	2 009520112
E14	17	2 009520114
E16	19	2 009520116
E18	21	2 009520118
E20	23	2 009520120



952FTX/S9
E6-E7-E8-E10-E12
E14-E16-E18-E20

1 009520141

953

chiavi a T con maschio esagonale snodato

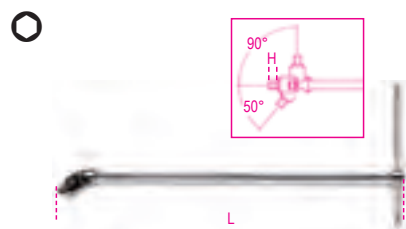

UNI 6754

mm	H mm	L mm	
3	5	395	5 009530130
3,5	6	395	3 009530135
4	6	395	5 009530140
4,5	7	395	3 009530145
5	7	395	5 009530150
6	9	400	5 009530160
7	10	425	3 009530170
8	11	425	5 009530180
10	13	440	5 009530200



953/S5
3-4-5-6-8 mm

1 009530305

953/S9
3-3,5-4-4,5
5-6-7-8-10 mm

1 009530301

953TX

chiavi a T con maschio snodato
per viti con impronta Torx®

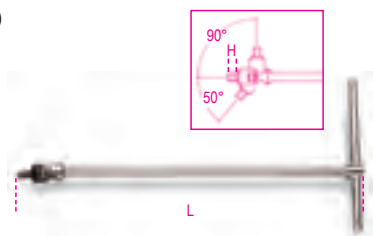

Ø	H mm	L mm		
T20	11	396	2	009530020
T25	11	396	2	009530025
T27	11	396	2	009530027
T30	13	400	2	009530030
T40	13	400	2	009530040
T45	13	426	2	009530045
T50	14	442	2	009530050
T55	14	442	2	009530055



953TX/S8
T20-T25-T27-T30
T40-T45-T50-T55

1 009530060

955

chiave a tubo semplice
per candele d'accensione



Ø	D mm	L mm		
16	21	86	3	009550016
5/8				
20,8	29	86	3	009550021
13/16				

956C

chiavi a bussola
con attacco quadro femmina 1/2"
per candele d'accensione



ISO 11168

Ø	L mm		
14	18,8	70	3 009560008
9/16			
16	21,4	70	3 009560010
5/8			
17,8	23,6	70	3 009560011
11/16			
20,8	27,0	70	3 009560012
13/16			

956E

chiavi a bussola
con attacco quadro femmina 3/8"
per candele d'accensione



ISO 11168

Ø	L mm		
14	18,8	70	3 009560018
9/16			
16	21,4	70	3 009560020
5/8			
17,8	23,6	70	3 009560021
11/16			
20,8	27,0	70	3 009560022
13/16			

956L

chiavi a bussola poligonale
con attacco quadro femmina 1/2"
tipo lungo, per candele d'accensione



Ø	L mm		
14	20,2	250	2 009560214
9/16			
16	24,0	250	2 009560216
5/8			
17,8	24,0	250	2 009560217
11/16			
20,8	28,5	250	2 009560221
13/16			

957

chiavi a T con bussola snodata
per candele d'accensione

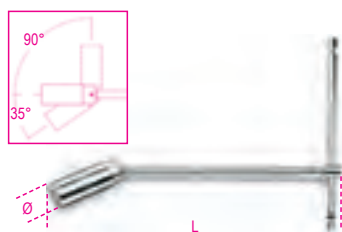

ISO 11168

Ø	L mm		
16	21,4	275	3 009570000
5/8			
20,8	27,0	275	3 009570001
13/16			

959

chiavi a T con bussola snodata
tipo normale, per candele d'accensione

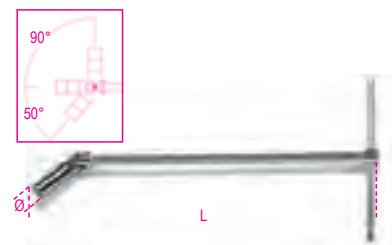

ISO 11168

Ø	L mm		
14	18,8	483	3 009590009
9/16			
16	21,4	483	3 009590010
5/8			
20,8	27,0	527	3 009590011
13/16			

959R

gommino e molla di ricambio
per 956C - 956E - 957 - 959

959R/14	3 009590223
956C/14-956E/14	
959R/16	3 009590224
956C/16-956E/16	
957/16-959/16	
959R/17,8	3 009590225
956C/17,8-956E/17,8	
959R/20,8	3 009590226
956C/20,8-956E/20,8	
957/20,8-959/20,8-959L	

960

chiavi a bussola
con attacco quadro femmina 1/2"
per iniettori motori Diesel



Ø	L mm		
27	36,5	77	2 009600027

960A

chiavi a bussola
con attacco quadro femmina 1/2"
per iniettori motori Diesel

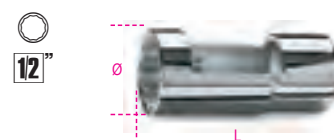

Ø	L mm		
27	36,5	77	2 009600017

960BT

chiavi a bussola per le connessioni elettriche degli iniettori



mm	Ø mm	L mm		
25	37,0	78	1	009600125
27	39,7	78	1	009600127
29	42,0	78	1	009600129
30	43,0	78	1	009600130

960BT/B

chiavi a bussola per le connessioni elettriche degli iniettori

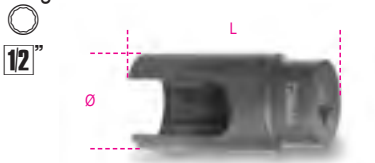

mm	Ø mm	L mm		
29	38,5	77	1	009600128

960F

chiave a bussola per ghiere portainiettori



Ø mm	Ø1 mm	●1 mm	●2 mm		
28,3	22	32	22	1	009600148

960G

chiave a bussola per ghiere portainiettori



Ø mm	Ø1 mm	● mm	L mm		
28,5	22	32	122	1	009600151

960L

chiave a bussola per ghiere portainiettori



Ø mm	Ø1 mm	L mm		
30	22	122	1	009600153

960M

chiave a bussola per ghiere portainiettori

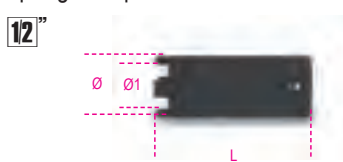

Ø mm	Ø1 mm	L mm		
28,5	22	72	1	009600154

960H/C4

serie di bussole per ghiere portainiettori



960H/C4	1	009600152
---------	---	-----------

960S

chiavi a bussola con attacco quadro femmina 1/2" per iniettori motori Diesel

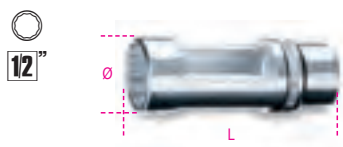

mm	Ø mm	L mm		
22	30	82	1	009600022

960SL

chiavi a bussola per sonda Lambda con attacco quadro femmina 1/2"



	Ø mm			
960SL85	33	2	009600085	
○ 22xL= 85 mm				
960SL110	33	2	009600110	
○ 22xL= 110 mm				

960SN

chiavi per candlette di preriscaldamento motori Diesel



mm	Ø mm	□		
8	12,0	1/4	2	009600834
9	13,3	1/4	2	009600835
10	14,5	3/8	2	009600836
11	15,8	3/8	2	009600837
12	17,0	3/8	2	009600838

960/22EP

chiave snodata a doppia impronta per sonde Lambda
grande versatilità d'uso grazie alla doppia impronta esagonale/poligonale e allo snodo a 180°



L mm	Ø mm	○ mm		
300	22	22	1	009600052

960AVE

attrezzo verifica elettroiniettori Diesel Common Rail
BOSCH, SIEMENS, DENSO e DELPHI.



960AVE	1	009600245
--------	---	-----------

430x310x50 mm - 2,0 kg

960K/AVE2

kit adattatori per 960AVE

(già inclusi nel 960AVE)



960K/AVE	1	009600249
----------	---	-----------

250x150x30 mm - 523 g

960CMB

strumento per controllo
compressione su motori a benzina



Bar
4÷17

1 009600250

440x370x100 mm - 2,2 kg

960CMD

strumento per controllo
compressione su motori Diesel



Bar
8÷40

1 009600270

440x370x100 mm - 2,4 kg

960EPC

set di utensili per l'estrazione dell'elettrodo
delle candele di preriscaldamento



ZONA DI ROTTURA

960EPC

1 009600790

270x230x80 mm - 900 g

960E-PI/P

estrattore per rondelle iniettori

• filetto maschio M10 per utilizzo
con estrattore a massa battente (Beta 1540)



960 E-PI/P

1 009600706

300x90x60 mm

960KC-M8

assortimento di utensili per la rimozione
delle candele di preriscaldamento M8
spezzate o danneggiate

• Per candele con filetto M8x1.0 mm
• Permette di rimuovere agevolmente le candele spezzate
bloccate nella testata



960 KC-M8

1 009600800

400x300x60 mm - 1,5 kg

960KC-M8/M9/M10

assortimento di utensili per la rimozione
delle candele di preriscaldamento spezzate
o danneggiate

• Per candele con filetto M8-M9-M10



960KC-M8/M9/M10

1 009600801

380x290x50 mm - 2,3 kg

960KPC

estrattore reversibile ad impulsi
con coppia regolabile
per candele di preriscaldamento
Coppia regolabile in 4 posizioni:
10-20-30-40 Nm

14"



960KPC

1 009600780

8-9-10-11-12 mm

420x185x60 mm - 2,8 kg

960P

tester per controllo pressione/depressione
con accessori e adattatori



960P

1 009600777

350x320x95 mm - 1,9 kg

960PI

assortimento di alesatori per la pulizia della
sede iniettori
in cassetta di plastica

Per pulire i residui all'interno della sede iniettori

- Alesatore piatto da Ø 19 - 15 mm per iniettori universali
- Alesatore piatto da Ø 17 - 17 mm per iniettori Delphi/Bosch
(BMW/PSA/Renault/Ford)
- Alesatore piatto da Ø 19 - 17 mm per iniettori Bosch
(Mercedes CDI).
- Alesatore ad angolo da Ø 21 - 17 mm per iniettori Fiat/Iveco.
- Impugnatura



960PI

1 009600215

250x130x50 mm - 600 g

960PI/P

assortimento di 14 utensili speciali e alesatori per la pulizia della sede iniettori



Inclusi nell'assortimento:

- 3 alesatori piatti da $\varnothing 19/15$ mm - $\varnothing 17/17$ mm - $\varnothing 19/17$ mm
- 2 alesatori ad angolo da $\varnothing 21/17$ mm - $\varnothing 17/17$ mm
- utensile per estrazione rondella iniettore
- spazzole per pulizia frese
- spazzola per pulizia iniettore
- impugnatura e accessori per l'utilizzo delle frese

960PI/P

1 009600216

373x280x61 mm - 2,5 kg

960PI/S

kit per pulizia sedi iniettori

Il kit include:

- 3 spazzole in acciaio $\varnothing 18, 22, 25$ mm per pulizia sedi iniettori
- 2 spazzole $\varnothing 14$ e 16 mm per pulizia fondo sedi iniettori
- 6 tappi per occlusione foro collegamento camera di combustione
- 1 scovolino per pulizia foro collegamento camera di combustione
- 1 portainseri flessibile con impugnatura

14



960PI/S

1 009600214

360x140x50 mm - 700 g

960PMC

pompa manuale per taratura e controllo iniettori Diesel



360 mm

Bar Max.
400

1 009600200

960AVL

aspiratore di vapori



Bar Max.
6

1 009600210

960AD/TP2

set di adattatori per 1464T e 960TP in valigetta di plastica



960AD/TP2

1 009600510

430x310x50 mm - 3,2 kg

960W

ricevitore wireless per PC (per 960TP - 960TAP)

Adatto per sistemi Windows 2000 SP3, XP, Vista e 7



CE

960W

1 009600400

961D

videoscopio digitale elettronico con sonda da 5,5 mm

- permette di visualizzare, fotografare e registrare singole immagini e filmati direttamente sullo strumento



- sonda con testa $\varnothing 5,5$ mm e lunghezza 90 cm
- display LCD TFT da 7" (18 cm) con risoluzione da 800x480
- camera digitale con visione frontale e laterale
- connessione della sonda di tipo "Cfast"
- rilevamento video con frequenza di 15 fotogrammi per secondo
- zoom digitale 2X
- connettore Micro-USB per il trasferimento delle immagini
- uscita video micro-HDMI
- ingresso micro-SD card
- ingresso micro-USB
- l'alimentatore permette all'unità di essere usata mentre la batteria è in carica
- microfono e altoparlante per inserire e ascoltare annotazioni vocali durante la registrazione/riproduzione
- connessione Wi-Fi

961D

1 009610500

400x340x85 mm - 2,6 kg

961D/CF3,8

sonda da 1 metro con camera frontale da 3,8 mm per videoscopio 961D



961D/CF3,8

1 009610511

961D/DC8,5

sonda da 1 metro con doppia camera UV per videoscopio 961D



$\varnothing 8,5$ mm

961D/DC8,5

1 009610513

Beta

961P6

videoscopio elettronico
con sonda flessibile



- Schermo TFT LCD 3,2"
- Supporta l'utilizzo di SD CARD (8 GB)
- Supporta memorie flash (8 GB)
- Memoria interna da 64M
- Uscita TV-OUT
- Supporta i formati video (MP4, AVI, 3GP)
- 4 led di illuminazione
- Alimentazione tramite presa USB (batteria incorporata)

CARATTERISTICHE TECNICHE

- Pixel del sensore: 640x480
- Risoluzione massima: 320x240
- Lunghezza sonda: 1 mt.
- Diametro camera: 6 mm
- Formati video: MPEG4, 3GP, AVI, ASF.
- Formati foto: JPEG
- Angolo di ripresa: 0÷180°
- Uscita dati: cavo USB e SD card
- Alimentazione: batteria 3,7V 2000 mAh

961P6 1 009610000

961P6/S

sonde flessibili 6 mm



	L mm	
961 P6/S-2MT	2000	1 009610262
961 P6/S-3MT	3000	1 009610263

962

levagomme



L mm	A mm	
300	21	5 009620003
400	25	5 009620004
500	27	3 009620005
600	27	3 009620006

963

leva con estremità a punta
e piatta curva



L mm	A mm	
400	23	5 009630001

964

leva con estremità a punta
e a becco



L mm	A mm	
400	46	5 009640001

965

leve con estremità piatta curva



L mm	A mm	L1 mm	
300	16	185	2 009650013
450	20	312	2 009650014
600	20	462	2 009650016



965/S3 1 009650019

966/C3

serie di 3 leve con testa snodata piatta curva



966/C3
L=200-250-300 mm
355x140x65 mm - 1,8 kg

969A

chiave a bussola per serraggio
dado mozzo

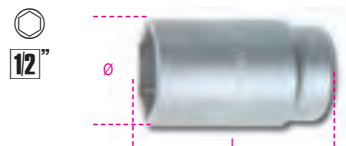

mm	mm	L mm	
35	46	76	1 009690035

720LS



mm	mm	L mm	mm	mm	
720LS 36	36	48,0	78	29	2 007200386

969B

chiave a bussola per serraggio
dado mozzo

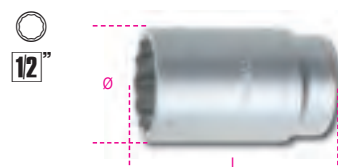

mm	mm	L mm	
24	36,0	76	1 009690124
27	36,0	76	1 009690127
30	40,0	76	1 009690130
31	42,0	76	1 009690131
32	42,5	76	1 009690132
34	45,0	76	1 009690134
36	49,0	76	1 009690136

969/C5

serie di 5 chiavi a bussola
per serraggio dado mozzo
in valigetta di plastica



969/C5 1 009690200

969A	35
969B	30-32-34-36

970EA

chiavi a bussola Macchina per dadi assale



mm	mm	mm	
98	36	122	1 009700398

Beta

970EB

chiavi a bussola Macchina per dadi assale



mm	mm	Ø		
95	36	126	1	009700595
110	36	133	1	009700410

970Q

chiavi a bussola Macchina per dadi rettangolari



L	□		
56	3/4"	1	009700756
60	3/4"	1	009700760

970B

chiave a bussola per serraggio dadi mozzo Fiat Daily

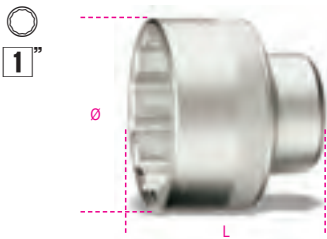

mm	Ø	L	
65	88	75	1 009700010

970C

chiavi a bussola Macchina bocca ottagonale per dadi mozzi



mm	□-Ø		
80	41 mm	1	009700808
95	3/4"	1	009700815
100	3/4"	1	009700820
109	41 mm	1	009700829
115	3/4"	1	009700835
120	41 mm	1	009700840

9700T

chiavi a bussola Macchina bocca ovale per dadi mozzi rimorchi



L	L1	□-Ø		
65	61	3/4"	1	009700165
80	73	3/4"	1	009700180
96	90	3/4"	1	009700196
111	104	41 mm	1	009700211

971TSP

strumento per sensori di pressione dei pneumatici



CARATTERISTICHE

- lettura delle informazioni dai sensori TPMS quali:
ID del sensore
pressione di gonfiaggio
temperatura
stato batteria
- attivazione dei sensori
- programmazione sensori universali

Lo strumento dispone di una banca dati che supporta le operazioni di riparazione come:

- coppie di serraggio
- codici di ricambio originali e di sensori universali compatibili

971TSP 1 009710025

63x142x30 mm

Beta

971/C8

giravite dinamometrico con accessori per il serraggio controllato delle valvole dei pneumatici con sistema di controllo della pressione



971/C8 1 009710108

	583/6	1,2+6 Nm
	892/0	
	862TX	T10-T15-T20
	900L	11-12 mm
	986 78	

978 - 979

chiavi a croce per dadi ruote

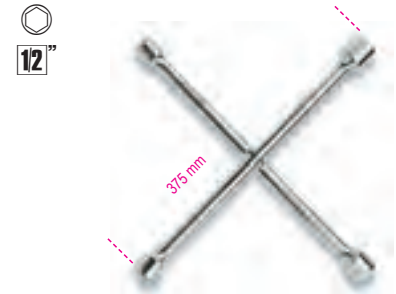

UNI/ISO 6788 DIN 3119

978 2 009780001
17x19x21x22 mm

979 2 009790001
17x19x22x1/2 mm

982

chiavi a croce per dadi ruote

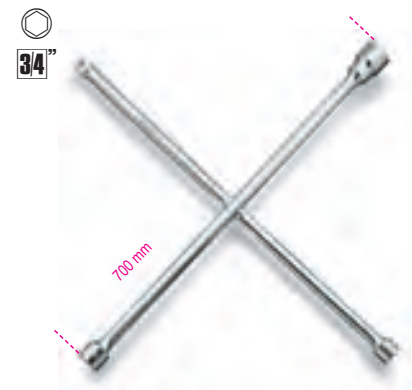

UNI/ISO 6788 DIN 3119

24x27x32x3/4 mm 1 009820001

985/B7

assortimento di 7 perni guida per montaggio ruote

Misure incluse:

- M12x1,25 maschio
- M12x1,25 femmina
- M12x1,5 maschio
- M12x1,5 femmina
- M14x1,25 maschio
- M14x1,5 maschio
- M16x1,5 maschio



985 /B7

1 009850007

985M

perni guida maschio per montaggio ruote



	L mm		
985M/M12x1,25	150	1	009850101
985M/M12x1,50	150	1	009850102
985M/M14x1,25	150	1	009850103
985M/M14x1,50	150	1	009850104
985M/M16x1,50	150	1	009850105

985F

perni guida femmina per montaggio ruote



	L mm		
985F/F12x1,25	150	1	009850106
985F/F12x1,50	150	1	009850107

986 48

giravite per valvole pneumatiche modello corto

ritenzione automatica della valvola



L mm 18 L1 mm 48 1 009860048

986 78

giravite per valvole pneumatiche

ritenzione automatica della valvola



L mm 18 L1 mm 78 1 009860078

987

leva per valvole pneumatiche con protezione in gomma



L mm 310 1 009870001

987P

leva per valvole pneumatiche in materiale plastico

nel manico è incluso il giravite per agire sul meccanismo interno alla valvola



L mm 335 1 009870011

988/K4

serie di 4 scalpelli in plastica anti graffio



988/K4 A= 19-21-25-38 mm 1 009880104

989

pinza combinata per equilibratura ruote



L mm 250 2 009890001

990

pinzetta a molla a punte fini dritte arrotondate, zigrinate in acciaio inossidabile



L mm 130 5 009900001

991

pinzetta a molla a punte fini curve arrotondate, zigrinate in acciaio inossidabile



L mm 130 5 009910001

992

pinzetta a molla con perno a punte fini dritte arrotondate zigrinate, in acciaio inossidabile



L mm 150 5 009920001

993

pinzetta a molla con perno a punte fini curve arrotondate zigrinate, in acciaio inossidabile



L mm 145 5 009930001

993PL

pinzetta a molla a punte fini curve arrotondate, zigrinate in acciaio inossidabile



L mm 150 3 009930010

993G

pinzetta a molla con perno, a punte curve a gomito arrotondate, zigrinate in acciaio inossidabile



L
mm
160 3 009930030

994

pinzetta a molla a punte larghe diritte arrotondate, zigrinate in acciaio inossidabile



L
mm
150 5 009940001

994PL

pinzetta a molla a punte larghe diritte arrotondate, zigrinate in acciaio inossidabile



L
mm
150 3 009940010

994TF

pinzetta a molla, antiacido antimagnetica, a punte larghe diritte arrotondate, zigrinate in acciaio inossidabile



L
mm
150 3 009940020

996

pinzetta a molla a becchi dritti a spatola in acciaio inossidabile



L
mm
150 5 009960001

998

pinzetta a molla a becchi larghi dritti incrociati, zigrinati in acciaio inossidabile



L
mm
155 5 009980001

999

pinzetta a molla antiacido antimagnetica, a punte piatte arrotondate in acciaio inossidabile



L
mm
115 3 009990011

999A

pinzette a molla, antiacido antimagnetica, a punte corte finissime in acciaio inossidabile



L
mm
120 3 009990015

999B

pinzetta a molla, antiacido antimagnetica, a punte forti diritte in acciaio inossidabile



L
mm
120 3 009990017

999C

pinzetta a molla, antiacido antimagnetica, a punte finissime diritte in acciaio inossidabile



L
mm
110 3 009990019

999D

pinzetta a molla, antiacido antimagnetica, a punte finissime angolate, in acciaio inossidabile



L
mm
115 3 009990021

999E

pinzetta a molla, antiacido antimagnetica, a punte finissime curve in acciaio inossidabile



L
mm
120 3 009990023

999G

pinzetta a molla, antiacido, antimagnetica con dispositivo di bloccaggio, a punte finissime diritte in acciaio inossidabile



L
mm
140 3 009990027

999/B6

serie di 6 pinzette a molla antiacido ed antimagnetiche



999/B6
999-999A-999B
999C-999D-999E
1 009990050

1002

pinzetta autobloccante a becchi arrotondati, zigrinati in acciaio inossidabile



L
mm
160 2 010020001

1008

pinze a becchi piatti lunghi zigrinati manici ricoperti con 2 strati di PVC antiscivolo



ISO 5745
L L1
mm mm
160 51,5 5 010080006

1008BM

pinze a becchi piatti lunghi zigrinati impugnatura bimatereale



ISO 5745
L L1
mm mm
160 51,5 3 010080036

1009

pinza a becchi mezzotondi lunghissimi zigrinati
manici ricoperti con 2 strati di PVC antiscivolo



L	L1		
mm	mm		
160	56,5	2	010090006

1009L/A

pinza a becchi mezzotondi lunghissimi dritti zigrinati, per impieghi speciali
manici ricoperti con 2 strati di PVC antiscivolo



L	L1		
mm	mm		
283	80	2	010090008

1009L/B

pinza a becchi mezzotondi lunghissimi zigrinati piegati a 45°
per impieghi speciali
manici ricoperti con 2 strati di PVC antiscivolo



L	L1		
mm	mm		
273	73	2	010090009

1009L/C

pinza a becchi mezzotondi lunghissimi zigrinati piegati a 90°
per impieghi speciali
manici ricoperti con 2 strati di PVC antiscivolo



L	L1		
mm	mm		
253	45	2	010090010

1009L/D

pinza a becchi mezzotondi lunghissimi dritti zigrinati, con doppio snodo
manici ricoperti con 2 strati di PVC antiscivolo



L	L1		
mm	mm		
342	71	1	010090058

1009L/DP

pinza a becchi mezzotondi lunghissimi zigrinati piegati a 45°, con doppio snodo
manici ricoperti con 2 strati di PVC antiscivolo

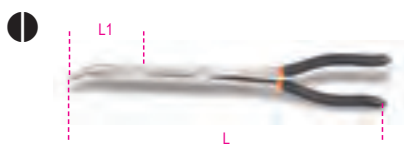

L	L1		
mm	mm		
336	66	1	010090059

1010

pinze a becchi tondi lunghi
manici ricoperti con 2 strati di PVC antiscivolo



ISO 5745

L	L1		
mm	mm		
160	51,5	2	010100006

1010BM

pinze a becchi tondi lunghi
impugnatura bimatereale



ISO 5745

L	L1		
mm	mm		
160	51,5	2	010100036

1031/S4

serie di 4 pinze per anelli elastici di sicurezza



1031/S4 1 010310000

1032	180	19 ÷ 60
1034	170	19 ÷ 60
1036	175	19 ÷ 60
1038	175	19 ÷ 60

1032

pinze a becchi dritti
per anelli elastici di sicurezza, per fori
manici ricoperti in PVC



UNI 7914 DIN 5256

L	Ø		
mm	mm		
140x0,9	8÷12	5	010320013
140x1,3	12÷25	5	010320014
180	19÷60	5	010320017
225	40÷100	3	010320021
300	85÷200	2	010320028

1033

pinze a becchi piegati a 45°
per anelli elastici di sicurezza, per fori
manici ricoperti in PVC



UNI 7914 DIN 5256

L	Ø		
mm	mm		
140x0,9	8÷12	5	010330013
140x1,3	12÷25	5	010330014
180	19÷60	5	010330017
225	40÷100	3	010330021

Beta

Beta

1034

pinze a becchi piegati a 90°
per anelli elastici di sicurezza, per fori
manici ricoperti in PVC



UNI 7914 DIN 5256

L mm	∅ mm	
130x0,9	8÷12	5 010340013
130x1,3	12÷25	5 010340014
170	19÷60	5 010340017
210	40÷100	3 010340021
290	85÷200	2 010340028

1034L

pinza a becchi piegati a 90° lunghi
per anelli elastici di sicurezza, per fori
manici ricoperti in PVC



L mm	∅ mm	
190	40÷100	2 010340320

1036

pinze a becchi dritti
per anelli elastici di sicurezza per alberi
manici ricoperti in PVC



UNI 7915 DIN 5254

L mm	∅ mm	
140x0,9	3÷10	5 010360013
140x1,3	10÷25	5 010360014
175	19÷60	5 010360017
225	40÷100	3 010360021
300	85÷200	2 010360028

1037

pinze a becchi piegati a 45°
per anelli elastici di sicurezza per alberi
manici ricoperti in PVC



UNI 7915 DIN 5254

L mm	∅ mm	
140x0,9	3÷10	5 010370013
140x1,3	10÷25	5 010370014
175	19÷60	5 010370017
225	40÷100	3 010370021

1038

pinze a becchi piegati a 90°
per anelli elastici di sicurezza per alberi
manici ricoperti in PVC



UNI 7915 DIN 5254

L mm	∅ mm	
135x0,9	3÷10	5 010380013
135x1,3	10÷25	5 010380014
175	19÷60	5 010380017
220	40÷100	3 010380021
300	85÷200	2 010380028

1039

pinza reversibile a becchi dritti
per anelli elastici di sicurezza per fori
e alberi, manici ricoperti in PVC



L mm	∅ mm	∅ mm	
150	10÷15	6÷25	2 010390015

1044

pinza regolabile
cerniera sovrapposta
manici ricoperti con 2 strati di PVC antiscivolo

· modello a nove posizioni

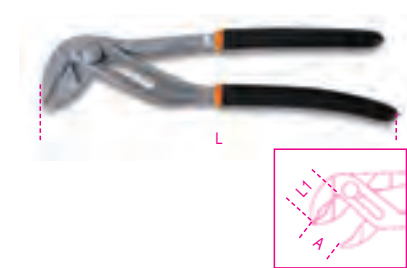

ISO 8976

L mm	A max mm	L1 mm	
250	48	39	5 010440250

1044F

pinza regolabile, fosfatata
cerniera sovrapposta
manici ricoperti in PVC

· modello a nove posizioni



ISO 8976

L mm	A max mm	L1 mm	
250	48	39	5 010440015

1046

pinza regolabile
cerniera a cremagliera sovrapposta
manici ricoperti in PVC



ISO 8976

L mm	A max mm	L1 mm	
240	28	33	5 010460240
400	107	55	1 010460400

1047

pinza regolabile a pulsante,
manici ricoperti con due strati
di PVC antiscivolo

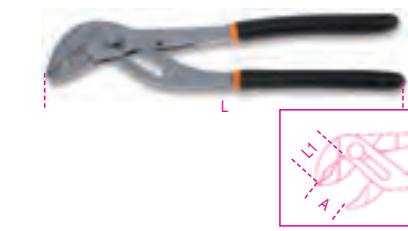

L mm	A max mm	L1 mm	
180	30	29	2 010470180
240	36	35	2 010470240
300	50	48	1 010470300

1047BM

pinza regolabile a pulsante con impugnatura
bimateriale

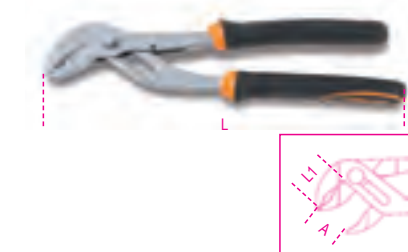

L mm	A max mm	L1 mm	
240	36	35	2 010470340

1048

pinze regolabili cerniera chiusa
manici ricoperti con 2 strati di PVC antiscivolo

· modello a nove posizioni

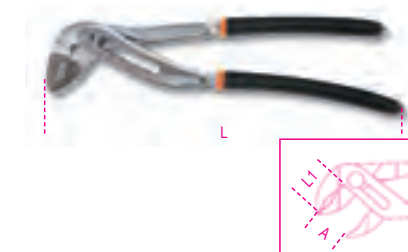

ISO 8976

L mm	A max mm	L1 mm	
175	30	29	3 010480010
250	48	39	5 010480015
300	56	47	2 010480020

1048BM

pinza regolabile a cerniera chiusa,
impugnatura bimateriale
· modello a nove posizioni

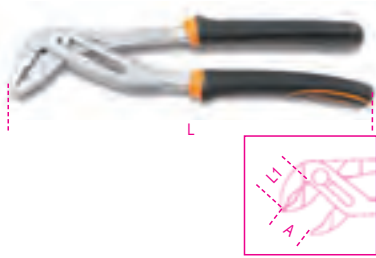

L mm	A max mm	L1 mm		
250	48	39	3	010480215

1048V

pinze regolabili
verniciate arancio
cerniera chiusa
· modello a nove posizioni

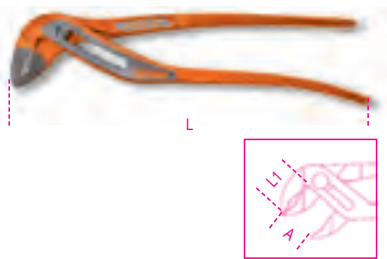

ISO 8976

L mm	A max mm	L1 mm		
175	30	29	3	010480110
250	48	39	5	010480115
300	56	47	2	010480120

1050

pinza autobloccante
a doppia regolazione

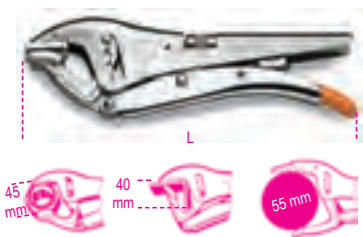

L mm		
220	2	010500022

1051

pinza autobloccante
a doppia regolazione, ganasce lunghe



L mm		
255	2	010510025

1051GM

pinza autobloccante
a doppia regolazione, ganaschia oscillante

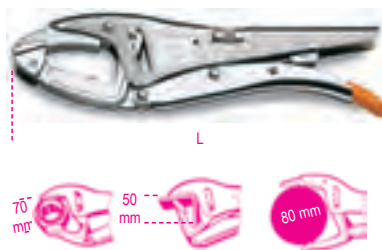

L mm		
255	2	010510250

1051L

pinza autobloccante a doppia regolazione
a grande capacità



L mm		
270	2	010510100

1051XL

pinza autobloccante a doppia regolazione
a grande capacità, ganasce extra lunghe



L mm		
270	2	010510140

1052

pinze regolabili autobloccanti
ganasce concave



L mm	A1 max mm		
140	22	3	010520014
190	36	3	010520019
240	42	3	010520024
300	55	2	010520030

1053

pinza regolabile autobloccante
ganaschia oscillante

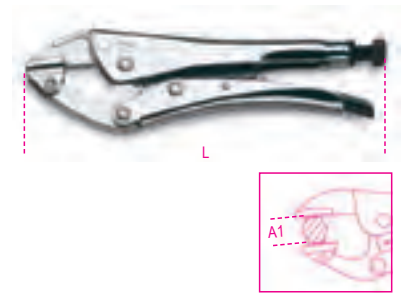

L mm	A1 max mm		
240	35	2	010530024

1054

pinza regolabile autobloccante
ganasce diritte

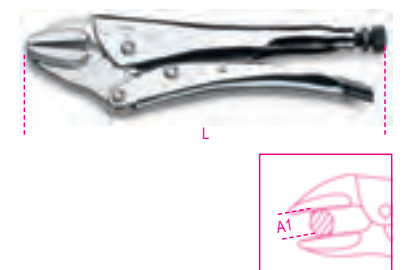

L mm	A1 max mm		
235	40	2	010540022

1055

pinza regolabile autobloccante
ganasce sagomate

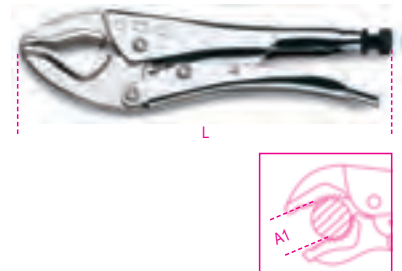

L mm	A1 max mm		
250	60	2	010550024

1056

pinza regolabile autobloccante
per frigoristi

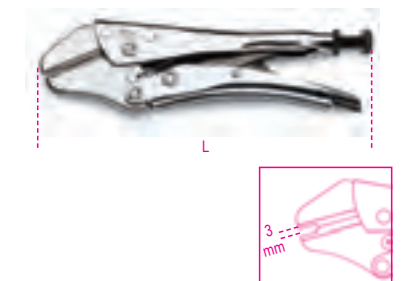

L mm		
190	2	010560019

1057A

pinza automatica autobloccante con regolazione della forza



L mm	2	010570124
240		

1058

pinze regolabili autobloccanti becchi lunghi

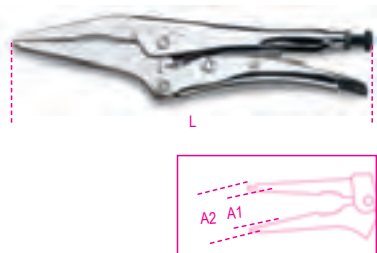

L mm	A1 max mm	A2 max mm		
180	38	/	2	010580018
240	65	100	2	010580024
310	80	150	2	010580031

1060

pinze regolabili autobloccanti ganasce a forcella

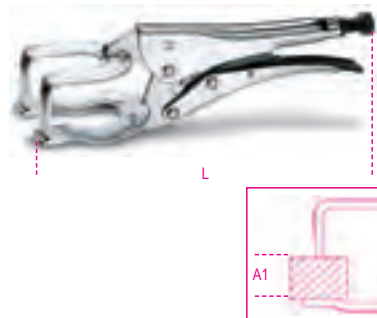

L mm	A1 max mm		
200	50	2	010600020
280	80	2	010600028

1061

pinza regolabile autobloccante ganasce a forcella

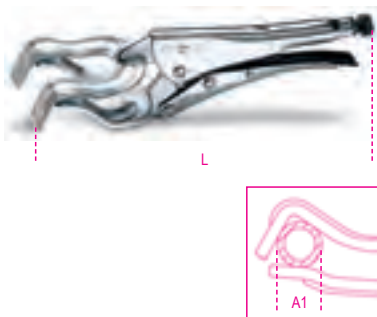

L mm	A1 max mm		
290	80	2	010610028

1062

pinze regolabili autobloccanti ganasce a collo di cigno

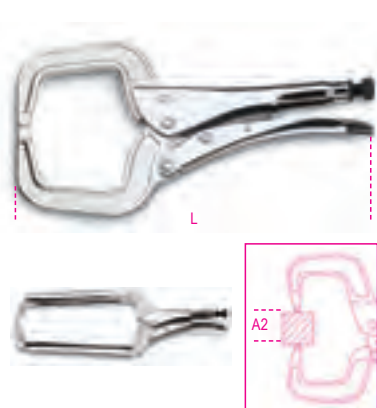

L mm	A1 max mm		
170	50	2	010620017
290	120	2	010620029
460	250	1	010620046

1062AL

pinze regolabili autobloccanti ganasce a collo di cigno in alluminio

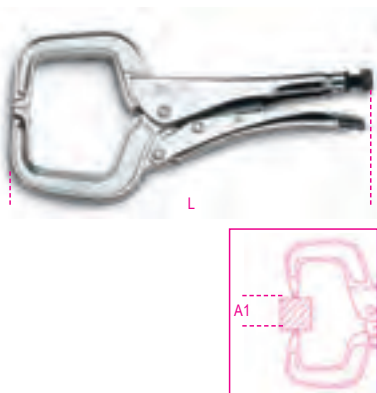

L mm	A1 max mm		
290	104	2	010620329

1062GM

pinze regolabili autobloccanti ganasce a collo di cigno oscillanti



L mm	A1 max mm		
170	45	2	010620217
290	88	2	010620229
460	260	1	010620246

1063

pinza regolabile autobloccante per lattonieri



L mm	A1 max mm		
200	30	2	010630020

1064

pinza regolabile autobloccante a catena

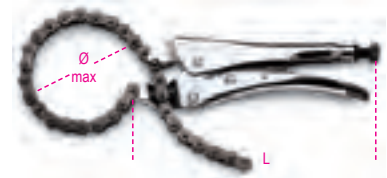

L mm	Ø mm		
240	150	2	010640024

1065F

pinza foralamiera

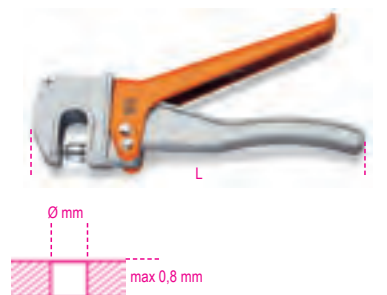

Ø mm	L mm		
5	228	1	010650010
6	228	1	010650015

1065P

pinza piegalamiera

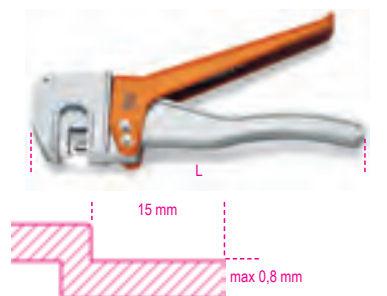

L mm			
228		1	010650020

1077

pinza a becchi larghi dritti per lattonieri manici ricoperti in PVC



L mm	A mm	L1 mm		
280	60	53	1	010770026

1078

pinza a becchi larghi piegati a 45°
per lattonieri
manici ricoperti in PVC



L	A	L1		
mm	mm	mm		
280	60	77	1	010780026

1080D

tronchesi a taglienti diagonali rasi
manici ricoperti con 2 strati
di PVC antiscivolo

Per taglio di materiali plastici

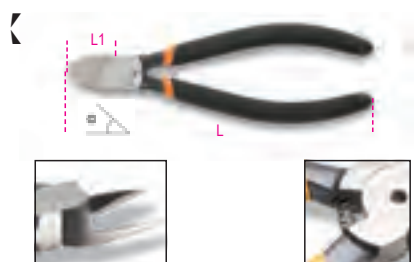

α	L	L1		
°	mm	mm		
15°	160	22	3	010800015
45°	160	22	3	010800045

1082

tronchesi a taglienti diagonali
manici ricoperti con 2 strati
di PVC antiscivolo



UNI/ISO 5749

L	L1	Φ		
mm	mm	mm		
140	20	1,6	5	010820004
160	22	1,6	5	010820006

1082BM

tronchesi a taglienti diagonali
impugnatura bimatereale



UNI/ISO 5749

L	L1	Φ		
mm	mm	mm		
140	20	1,6	3	010820034
160	22	1,6	3	010820036

1084

tronchesi a grande effetto
a taglienti diagonali, manici ricoperti
con 2 strati di PVC antiscivolo



UNI/ISO 5749

L	L1	Φ		
mm	mm	mm		
140	20	1,4	5	010840004
160	22	1,6	5	010840006
180	25	1,8	3	010840008
200	28	2,0	3	010840010

1084BM

tronchesi a grande effetto
a taglienti diagonali
impugnatura bimatereale



UNI/ISO 5749

L	L1	Φ		
mm	mm	mm		
140	20	1,4	3	010840034
160	22	1,6	3	010840036
180	25	1,8	3	010840038
200	28	2,0	3	010840040

1088

tronchesi a grande effetto
a taglienti frontali
manici ricoperti con 2 strati
di PVC antiscivolo



UNI/ISO 5748

L	L1	Φ		
mm	mm	mm		
160	9	1,6	2	010880006
200	11	2,0	2	010880010

1088BM

tronchesi a grande effetto
a taglienti frontali
impugnatura bimatereale



UNI/ISO 5748

L	L1	Φ		
mm	mm	mm		
160	9	1,6	2	010880036
200	11	2,0	2	010880040

1092V

tronchesi a doppia leva
a taglienti frontali
tipo pesante



UNI/ISO 5748

L	L1	Φ		
mm	mm	mm		
180	8	2,0	2	010920280
200	9	2,5	2	010920310

1094V

tronchese a doppia leva
taglienti diagonali
tipo pesante



UNI/ISO 5749

L	L1	Φ		
mm	mm	mm		
200	23	2,5	2	010940200

1095N

tronchese a doppia leva
a taglienti diagonali



L	L1	Φ		
mm	mm	mm		
195	26	1,6	2	010950010

1096

tenaglie per falegnami



ISO 9243

L	L1			
mm	mm			
160	21		5	010960016
200	23		5	010960020
250	30		5	010960025

1098

tenaglie per cementisti



ISO 9242 DIN 5242

L	L1		
~	mm		
190	12	5	010980190
220	13	5	010980220
250	15	5	010980250
280	18	5	010980280

1098PL

tenaglie per cementisti
manici ricoperti in PVC



ISO 9242 DIN 5242

L	L1		
~	mm		
220	13	5	010980320
250	15	5	010980350
280	18	5	010980380

1101

troncabulloni



L	L		
mm	mm		
300	12	2	011010030
350	14	2	011010035
450	18	1	011010045
600	24	1	011010060
750	30	1	011010075
900	36	1	011010090

L	R = 80		R = 140		g	
	Kgf/mm ²	Ø mm	Kgf/mm ²	Ø mm		
300	5	4	745			
350	6	5	1043			
450	7	6	1537			
600	9	7	2540			
750	11	8	3870			
900	12	9	6170			

1101R

lame di ricambio per 1101



mm	1101		
300	300	1	011010130
350	350	1	011010135
450	450	1	011010145
600	600	1	011010160
750	750	1	011010175
900	900	1	011010190

1102

minitroncabulloni

R = \approx 80 Kgf/mm²



L	Ø		
~	mm		
230	4	3	011020020

1104

tagliafuni per funi flessibili in acciaio
impugnatura in materiale plastico



L	Ø		
mm	mm		
420	12	1	011040004
600	16	1	011040006

1104R

lame di ricambio per 1104



mm			
420		1	011040014
600		1	011040016

1105

fustelle in acciaio
brunite

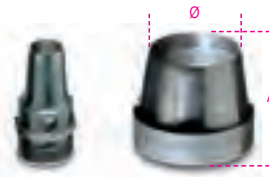

Ø	A		
mm	mm		
2	27	1	011050002
3	27	1	011050003
4	27	1	011050004
5	27	1	011050005
6	27	1	011050006
7	27	1	011050007
8	27	1	011050008
9	27	1	011050009
10	27	1	011050010
12	27	1	011050012
14	27	1	011050014
16	27	1	011050016
18	27	1	011050018
20	27	1	011050020
22	32	1	011050022
24	32	1	011050024
26	32	1	011050026
28	32	1	011050028
30	32	1	011050030
32	37	1	011050032
34	37	1	011050034
36	37	1	011050036
38	37	1	011050038
40	37	1	011050040

Ø	A		
mm	mm		
42	42	1	011050042
44	42	1	011050044
46	42	1	011050046
48	42	1	011050048
50	42	1	011050050

1105T30

battifustella per fustelle 1105
da 3 a 30 mm



L			
mm			
155		1	011050201

1105T50

battifustella per fustelle 1105
da 2 a 50 mm



L			
mm			
155		1	011050202

1105AD-50

adattatore per battifustella 1105T50



Ø			
mm			
57		1	011050210

1105/C15T

assortimento di 15 fustelle
da 3 a 30 mm e 1 accessorio



1105/C15T			
		1	011050251

1105	3 - 4 - 6 - 8 - 10 - 12 - 14 - 16 - 18 - 20 - 22 - 24 - 26 - 28 - 30 mm
1105T30	
230x190x50 mm	

1105/C29T

assortimento di 29 fustelle
da 2 a 50 mm e 2 accessori



1105/C29T 1 011050252

1105 2-3-4-5-6-7-8-9-10-12-14-16-18-20-22-24-26-28-30-32-34-36-38-40-42-44-46-48-50 mm

1105T50
1105AD-50

325x280x55 mm

1112

cesoie modello americano
lame larghe diritte

R = 60 Kg/mm²



L	L1	S	A		
mm	mm	mm	mm		
200	50	0,5	26	2	011120020
250	62	0,8	33	2	011120025
300	76	1,0	37	2	011120030
375	76	1,2	44	1	011120037

1114

cesoie modello americano
lame strette diritte

R = 60 Kg/mm²

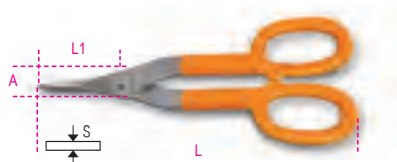

L	L1	S	A		
mm	mm	mm	mm		
250	58	0,5	15	1	011140265
350	76	1	22	1	011140340

1118

cesoia antinfortunistica per taglio reggia

Fe = acciaio comune
Inox = acciaio inossidabile



L	L1	Fe	Inox		
mm	mm	S mm	S mm		
310	42	1	0,8	2	011180001

1120A

cesoia roditrice

Fe = acciaio comune



L	Fe		
mm	S mm		
280	1,2	1	011200101

1120ARL - ARG

ricambi per 1120A



1120ARL	1	011200110
1120ARG	1	011200120

1122

cesoia a doppia leva
lame diritte

Inox = acciaio inossidabile



L	L1	Inox	A		
mm	mm	S mm	mm		
250	40	1	24	2	011220020

1123

cesoia a doppia leva destrorsa
lame curve

Inox = acciaio inossidabile



L	L1	Inox	A		
mm	mm	S mm	mm		
250	40	1	24	2	011230020

1124

cesoia a doppia leva sinistrorsa
lame curve

Inox = acciaio inossidabile



L	L1	Inox	A		
mm	mm	S mm	mm		
250	40	1	24	2	011240020

1125

cesoia a doppia leva
per tagli diritti e destrorsi
Inox = acciaio inossidabile

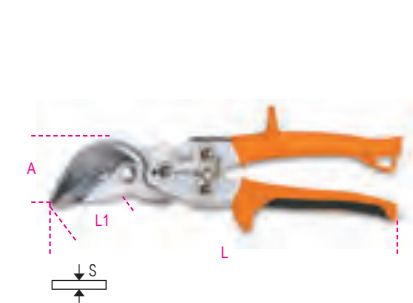

L	L1	Inox	A		
mm	mm	S mm	mm		
250	35	1	46	2	011250020

1126

cesoia a doppia leva
per tagli diritti e sinistrorsi
Inox = acciaio inossidabile

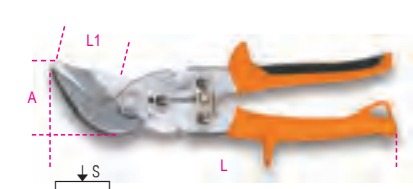

L	L1	Inox	A		
mm	mm	S mm	mm		
250	35	1	46	2	011260020

1122 - 1125MOL

1122 MOL	1122 - 1124	1	011220010
1123 MOL	1123	1	011230010
1125 MOL	1125 - 1126	1	011250040

1127

forbici per telefonisti lame diritte



L	L1		
mm	mm		
150	35	5	011270001



1128BAX

forbici per elettricisti a **doppio effetto**, con profili a fresa in acciaio inossidabile rivestito in DLC

taglio a doppio effetto: attraverso una speciale camma sul fulcro si ottiene uno scorrimento longitudinale delle lame che, nella fase di chiusura, ne aumenta la potenza di taglio.

profilo e fresa: studiate per allargare fori su plastica da 13 a 25 mm.

rivestimento DLC: Il DLC (diamond-like carbon) è un rivestimento innovativo a base di carbonio: l'elevata durezza ed il basso coefficiente d'attrito nascono dalla simultanea presenza di carbonio depositato sulla superficie in forma di grafite e diamante.

- alta durezza superficiale delle lame (resistenza all'abrasione e mantenimento dell'affilatura nel tempo)
- basso coefficiente di attrito (scorrevolezza e potenza di taglio)
- perno eccentrico antiallentamento
- manici ampi con gole strozzatubi



L mm	L1 mm	mm ²	5	011280088
150	50	50		

1128BCX

forbici per elettricisti lame diritte in acciaio inossidabile con microdentatura, gola tranciavaso e crimpatore per terminali a tubetto

con custodia plastica snodata



L mm	L1 mm	mm ²	5	011280080
155	55	50		

1128BMX

forbici per elettricisti lame diritte in acciaio inossidabile con microdentatura



L mm	L1 mm	mm ²	5	011280050
145	54			

1128BSX

forbici per elettricisti con svasatore lame dirtte in acciaio inossidabile

studiate per allargare fori su plastica e chiudere tubi corrugati
• con custodia plastica snodata



L mm	L1 mm	mm ²	5	011280060
145	50			

1128BTX

forbici per elettricisti lame dirtte in acciaio inossidabile con microdentatura e gola tranciavaso

• con custodia plastica snodata



L mm	L1 mm	mm ²	5	011280070
155	55	50		

1128BM

forbici per elettricisti lame dirtte



L mm	L1 mm	mm ²	5	011280000
145	50			

1129BM

forbici per elettricisti lame curve



L mm	L1 mm	mm ²	5	011290000
145	44			

1130BMX

forbici multiuso lame dirtte in acciaio inossidabile con microdentatura



L mm	L1 mm	mm ²	1	011300001
190	58			

1131CK

forbici per Kevlar® e fibre ottiche

in acciaio specificatamente studiato per operare su materiali antitaglio come fibre aramidiche
Anche per fibre ottiche

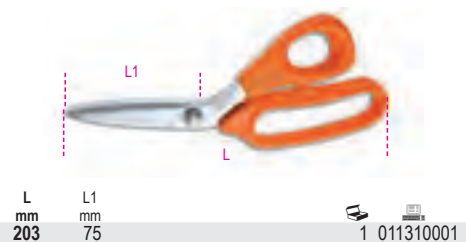

L mm	L1 mm	mm ²	1	011310001
203	75			

1132

tagliacavi manici ricoperti con 2 strati di PVC antiscivolo per taglio di cavi isolati di rame e alluminio

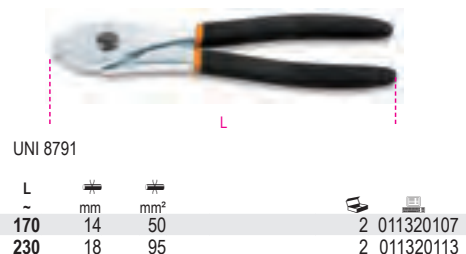

L mm	mm	mm ²	2	011320107
170	14	50		
230	18	95		011320113

1132BM

tagliacavi impugnature bimatereale per cavi isolati in rame e alluminio



L mm	mm	mm ²	2	011320137
170	14	50		
230	18	95		011320143

1133

tagliacavi per cavi in rame flessibile



L mm	mm	mm ²	1	011330001
600	32	300		

1133RL

lame di ricambio per 1133



1133RL 1 011330011

1134

tagliacavi a cricchetto



L mm 260
mm 35
mm² 400 1 011340032

1134RL

lama di ricambio per 1134



1134RL 1 011340132

1134A

tagliacavi a cricchetto



L mm 240
mm 45
mm² 500 1 011340045

1134A/RL

lama di ricambio per 1134A



1134A/RL 1 011340145

1136

tagliacavi per cavi di acciaio

Ø 5 mm per cavi con R ≤ 160 Kg/mm²
Ø 4 mm per bulloni in acciaio dolce



L mm 165 2 011360001

1142BM

pinza spellafili impugnatura bimateriale



UNI 7923
L mm 160
mm² 0,5÷6
mm 0-2,8 3 011420036

1143

pinza spellafili



L mm 165
mm² 1÷6
mm 1-3,2 1 011430001

1143R

lame di ricambio per 1143

1143R 1 011430011

1144D

spellacavi



L mm 170
mm² 4,5÷240
mm 2,5-18 1 011440010

1144D/RG

gancio di ricambio per 1144D



1144D/RG 1 011440012

1144D/RL

lame di ricambio per 1144D

1144D/RL 1 011440011

1144G

spellacavi

con lama regolabile per tagli trasversali e longitudinali



L mm 140
mm² 6÷75
mm 2.8-12 1 011440004

1144G/RL

lama di ricambio per 1144G



1144G/RL 1 011440005

1148A

pinza spellafili autoregolabile con dispositivo di taglio



L mm 190
mm² 0,02÷10
mm 0-4 1 011480100

1148A/R

lame di ricambio per 1148A



1148A/R 1 011480102

1148B

pinza spellafili autoregolabile con dispositivo di taglio



L mm 190
mm² 4÷16
mm 2-5 1 011480200

1148B/R

lame di ricambio per 1148B



1148B/R 1 011480202

1149F

pinza spellafili frontale autoregolabile, con dispositivo di taglio



L mm 175
mm² 0,2 ÷ 6
1 011490010

1150

pinze universali cromate lucide manici ricoperti con 2 strati di PVC antiscivolo



ISO 5746
L mm L1 mm $\frac{mm}{mm}$
160 37 1,6 5 011500006
180 41 1,8 5 011500008
200 45 2,0 5 011500010
220 50 2,0 2 011500012

1150BM

pinze universali cromate lucide impugnatura bimatereale



ISO 5746
L mm L1 mm $\frac{mm}{mm}$
160 37 1,6 3 011500036
180 41 1,8 3 011500038
200 45 2,0 3 011500040
220 50 2,0 2 011500042

1153

pinza regolabile a due posizioni manici ricoperti con 2 strati di PVC antiscivolo



UNI ISO 9343
L mm L1 mm
200 34 2 011530120

1162

pinze a becchi piatti lunghissimi diritti zigrinati manici ricoperti con 2 strati di PVC antiscivolo



ISO 5745
L mm L1 mm $\frac{mm}{mm}$
160 58 1,6 5 011620006
200 86 1,6 5 011620010

1162BM

pinze a becchi piatti lunghissimi diritti zigrinati impugnatura bimatereale



ISO 5745
L mm L1 mm $\frac{mm}{mm}$
160 58 1,6 3 011620036
200 86 1,6 3 011620040

1164

pinze a becchi piatti lunghissimi piegati zigrinati manici ricoperti con 2 strati di PVC antiscivolo

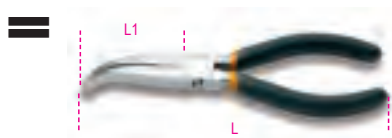

ISO 5745
L mm L1 mm $\frac{mm}{mm}$
160 54 1,6 5 011640006
200 76 1,6 5 011640010

1164BM

pinze a becchi piatti lunghissimi piegati zigrinati impugnatura bimatereale



ISO 5745
L mm L1 mm $\frac{mm}{mm}$
160 54 1,6 3 011640036
200 76 1,6 3 011640040

1166

pinze a becchi mezzotondi lunghissimi diritti zigrinati manici ricoperti con 2 strati di PVC antiscivolo



ISO 5745
L mm L1 mm $\frac{mm}{mm}$
160 56 1,6 5 011660006
200 76 1,6 5 011660010

1166BM

pinze a becchi mezzotondi lunghissimi diritti zigrinati impugnatura bimatereale



ISO 5745
L mm L1 mm $\frac{mm}{mm}$
160 56 1,6 3 011660036
200 76 1,6 3 011660040

1168

pinze a becchi mezzotondi lunghissimi piegati zigrinati manici ricoperti con 2 strati di PVC antiscivolo



ISO 5745
L mm L1 mm $\frac{mm}{mm}$
160 54 1,6 5 011680006
200 76 1,6 5 011680010

1168BM

pinze a becchi mezzotondi lunghissimi piegati zigrinati impugnatura bimatereale



ISO 5745
L mm L1 mm $\frac{mm}{mm}$
160 54 1,6 3 011680036
200 70 1,6 3 011680040

1171BM

pinza per elettronica
a becchi piatti corti lisci
impugnatura bimatériale



ISO 9655

L	L1	A	B
mm	mm	mm	mm
125	18	12	8



1173BM

pinza per elettronica
a becchi tondi corti
impugnatura bimatériale



ISO 9655

L	L1	A	B
mm	mm	mm	mm
125	22	12	8



1177BM/Z

pinza per elettronica
a becchi mezzotondi lunghi zigrinati
impugnatura bimatériale



ISO 9655

L	L1	A	B
mm	mm	mm	mm
140	39	12	8



1172BM

pinza per elettronica
a becchi piatti lunghi lisci
impugnatura bimatériale



ISO 9655

L	L1	A	B
mm	mm	mm	mm
140	40	12	8



1175BM

pinza per elettronica
a becchi mezzotondi corti lisci
impugnatura bimatériale



ISO 9655

L	L1	A	B
mm	mm	mm	mm
140	29	12	8



1178BM

pinza per elettronica
a becchi mezzotondi lunghi lisci rastremati
impugnatura bimatériale

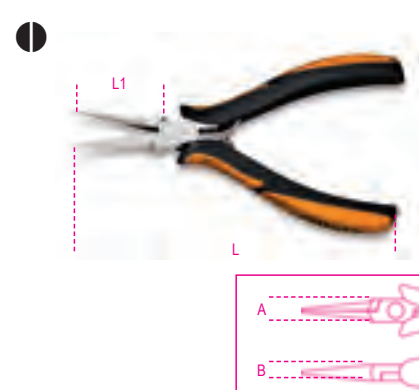

ISO 9655

L	L1	A	B
mm	mm	mm	mm
140	37	12	8



1172BM/P

pinza per elettronica
a becchi piatti lunghi piegati lisci
impugnatura bimatériale



L	L1	A	B
mm	mm	mm	mm
140	38	12	13



1177BM

pinza per elettronica
a becchi mezzotondi lunghi lisci
impugnatura bimatériale



ISO 9655

L	L1	A	B
mm	mm	mm	mm
140	38	12	8



1178BM/P

pinza per elettronica
a becchi mezzotondi lunghi lisci rastremati
piegati
impugnatura bimatériale

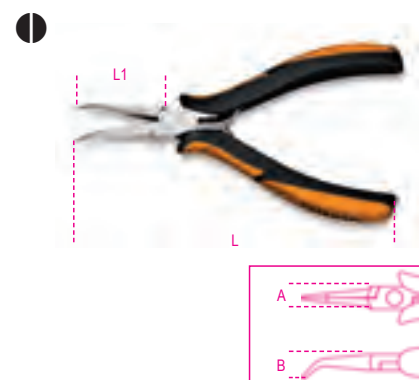

L	L1	A	B
mm	mm	mm	mm
140	36,5	12	12



1182BM

tronchese per elettronica
a taglienti diagonali semirasi
becchi assottigliati
impugnatura bimatériale



ISO 9654

L	L1	A	Cu
mm	mm	mm	mm
120	11	10	1

1183BM

tronchese per elettronica
a taglienti diagonali semirasi
becchi arrotondati
impugnatura bimatériale



ISO 9654

L	L1	A	Cu
mm	mm	mm	mm
120	11	10	1

1184BM

tronchese per elettronica
a taglienti diagonali rasi
becchi arrotondati
impugnatura bimatériale



ISO 9654

L	L1	A	Cu
mm	mm	mm	mm
120	11	10	1
130	13	12,5	1,25

1185BM

tronchese per elettronica
a taglienti diagonali rasi
becchi assottigliati
impugnatura bimatériale



ISO 9654

L	L1	A	Cu
mm	mm	mm	mm
120	11	10	1
130	13	12,5	1,25

1186BM

tronchese per elettronica
a taglienti diagonali rasi
becchi assottigliati scaricati
impugnatura bimatériale



ISO 9654

L	L1	A	Cu
mm	mm	mm	mm
120	11	10	1
130	13	12,5	1,25

1188BM

tronchese per elettronica
a taglienti diagonali normali
impugnatura bimatériale



ISO 9654

L	L1	A	Cu
mm	mm	mm	mm
125	12	12	1,25
130	17	15	2

1190BM

tronchese per elettronica
a taglienti frontali normali
impugnatura bimatériale



ISO 9654

L	L1	A	Cu
mm	mm	mm	mm
120	12	12	1,25

1191BM

tronchese per elettronica
a taglienti obliqui rasi
becchi lunghi sottili
impugnatura bimatériale



ISO 9654

L	L1	A	Cu
mm	mm	mm	mm
130	8	12	0,8

1191BM/L

tronchese per elettronica
a taglienti obliqui rasi e spellafilo
impugnatura bimatériale



ISO 9654

L	L1	A	Cu
mm	mm	mm	mm
130	18	12	1

1200MS

magnetizzatore-smagnetizzatore

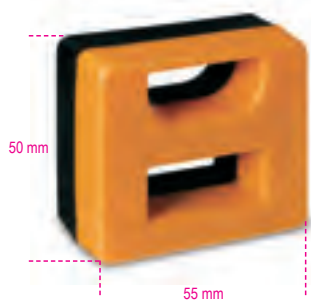

1200MS 5 012000000

1201

giravite per viti a testa con intaglio



ISO 2380

SxAxL mm	L1 mm	Ø mm	
0,4x2,5x50	146	2,5	5 012010003
0,4x2,5x75	166	2,5	5 012010006
0,5x3x75	171	3,0	5 012010009
0,5x3x100	196	3,0	5 012010012
0,6x3,5x75	171	3,5	5 012010018
0,6x3,5x100	196	3,5	5 012010021
0,8x4x100	196	4,0	5 012010030
0,8x4x125	221	4,0	5 012010033
0,8x4x150	246	4,0	5 012010036
1,0x5,5x100	209	5,0	5 012010039
1,0x5,5x125	234	5,0	5 012010040
1,0x5,5x150	259	5,0	5 012010042
1,2x6,5x100	220	6,0	5 012010048
1,2x6,5x150	270	6,0	5 012010051
1,2x8x150	282	8,0	3 012010057
1,2x8x200	332	8,0	3 012010060
1,6x10x200	332	9,5	3 012010066



1201/S6 1 012010206

0,5x3x75-0,6x3,5x100
0,8x4x100-1,0x5,5x100
1,2x8x150-1,6x10x200 mm

1201N

giravite per viti a testa con intaglio tipo cortissimo



ISO 2380

SxAxL mm	L1 mm	Ø mm	
0,8x4x30	86,5	4	3 012010103
1,2x6,5x30	86,5	6	3 012010106

1201DZ

giravite per viti con impronta Dzus®

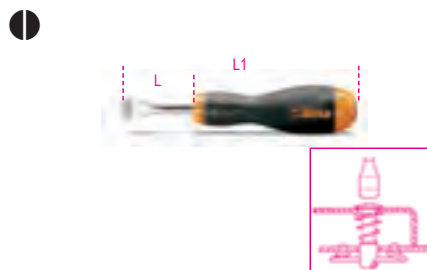

1201DZ L mm 53 L1 mm 173 2 012010501

1202

giravite per viti con impronta a croce Phillips®



UNI/ISO 8764

PHxDxL mm	L1 mm	
0x3x60	156	5 012020003
0x3x100	200	5 012020006
1x4,5x80	189	5 012020009
1x4,5x120	229	5 012020012
2x6x100	220	5 012020018
2x6x150	270	5 012020021
3x8x150	282	3 012020024
4x9,5x200	332	3 012020027



1202/S4 1 012020204

PH0x3x60-PH1x4,5x120
PH2x6x150-PH3x8x150 mm

1202N

giravite per viti con impronta a croce Phillips® tipo cortissimo



UNI/ISO 8764

PHxDxL mm	L1 mm	
1x4,5x30	86,5	3 012020103
2x6x30	86,5	3 012020106

1203/D

serie giravite



1203/D5 1 012030001

1201 0,6x3,5x100-1,0x5,5x150
1,2x6,5x150 mm
1202 PH1x4,5x80-PH2x6x100 mm

1203/D7 1 012030007

1201 0,5x3x75-0,8x4x100
1,0x5,5x100-1,2x6,5x150 mm
1202 PH0x3x60-PH1x4,5x80
PH2x6x100 mm

1203/D8 1 012030008

1201 0,5x3x75-0,8x4x125
1,0x5,5x150-1,2x6,5x150 mm
1202 PH0x3x60-PH1x4,5x80
PH2x6x100-PH3x8x150 mm

1203/D10N 1 012030019

1201 2,5x50-3x75-4x100-5,5x150
6,5x150 mm
1201N 4x30 mm
1202 PH0x60-PH1x80-PH2x100 mm
1202N PH1x30 mm

1203/D10 1 012030010

1201 0,4x2,5x50-0,5x3x75
0,8x4x100-1,0x5,5x100
1,2x6,5x150-1,2x8x150 mm
1202 PH0x3x60-PH1x4,5x80
PH2x6x100-PH3x8x150 mm

1203/D6 1 012030006

1202 PH1x4,5x80-PH2x6x100 mm
1204 0,4x2,5x60-0,5x3x100
0,8x4x100-1,0x5x125 mm

1203/D5PZ 1 012030003

1201 0,5x3x75-0,8x4x125
1,0x5,5x150 mm
1209PZ PZ1x4,5x80-PZ2x6x100 mm

1203/S10



1203/S10 1 012030021

1201 0,4x2,5x50-0,5x3x75
0,8x4x125-1,0x5,5x150
1,2x6,5x150-1,2x8x150 mm
1202 PH0x3x60-PH1x4,5x80
PH2x6x100-PH3x8x150 mm

1204

giravite per viti senza testa con intaglio



SxDxL mm	L1 mm		
0,4x2,5x60	156	5	012040003
0,5x3x100	196	5	012040009
0,8x4x100	196	5	012040012
1x5x125	234	5	012040018
1,2x6,5x150	270	5	012040024



1204/S5	1	012040205
0,4x2,5x60-0,5x3x100		
0,8x4x100-1x5x125		
1,2x6,5x150 mm		

1207TX

chiavi maschio con impugnatura per viti con impronta Torx®



	L mm	L1 mm	Ø mm		
T6	60	156	4	5	012070006
T7	60	156	4	5	012070007
T8	60	156	4	5	012070008
T9	60	156	4	5	012070009
T10	80	189	5	5	012070010
T15	80	189	5	5	012070015
T20	100	209	5	5	012070020
T25	100	209	5	5	012070025
T27	100	220	6	5	012070027
T30	100	220	6	5	012070030
T40	130	262	7	2	012070040
T45	130	262	8	2	012070045



1207TX/D7	1	012070207
T6-T8-T10-T15		
T20-T25-T30		

1208RTX

chiavi maschio con impugnatura per viti con impronta Tamper Resistant Torx®



	L mm	L1 mm	Ø mm		
T9	60	156	4	5	012080009
T10	80	189	5	5	012080010
T15	80	189	5	5	012080015
T20	100	209	5	5	012080020
T25	100	209	5	5	012080025
T27	100	220	6	5	012080027
T30	100	220	6	5	012080030
T40	130	262	7	2	012080040



1208RTX/D7	1	012080207
T9-T10-T15-T20		
T25-T27-T30		

1209PZ

giravite per viti con impronta a croce Pozidriv®-Supadriv®



UNI/ISO 8764

	L mm	L1 mm		
PZ 0	60	156	5	012090000
1	80	189	5	012090003
2	100	220	5	012090006
3	150	282	3	012090009



1209PZ/S4	1	012090204
PZ0-PZ1-PZ2-PZ3		

Beta WORK

1229LP

microgiravite per viti senza testa con intaglio

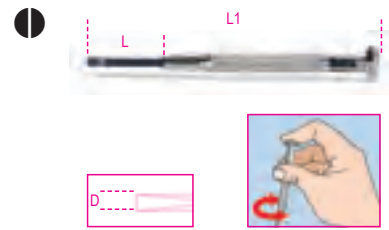

D mm	L mm	L1 mm		
1,0	17	75	5	012290210
1,2	21	85	5	012290212
1,4	21	89	5	012290214
1,8	23	94	5	012290218
2,0	23	98	5	012290220
2,4	26	103	5	012290224
3,0	28	108	5	012290230



1229LP/A6	1	012290300
1,2-1,4-1,8-2-2,4-3 mm		

1229PH

microgiravite per viti con impronta a croce Phillips®



PH	L mm	L1 mm		
0	26	102	5	012290250
1	29	107	5	012290251

1229LPH/A6

serie di 6 microgiravite 1229LP - 1229PH



1229LPH/A6	1	012290310
1229LP 1,4-2,0-2,4-3 mm		
1229PH PH0-PH1		

1236B

giravite a squadra per viti a testa con intaglio

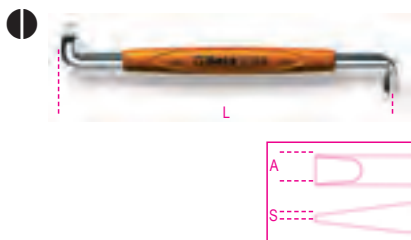

UNI 7079 DIN 5200

SxA	L		
mm	mm		
0,8x4	100	5	012360201
1x5,5	125	5	012360202
1,2x8	150	5	012360204

1238B

giravite a squadra per viti con impronta a croce Phillips®



UNI 7083 DIN 5208

PH	L		
	mm		
1-2	125	5	012380201
3-4	200	5	012380203

1241

giravite a battere per viti a testa con intaglio



SxAxL	L1		
mm	mm		
1x5,5x100	202	5	012410039
1,2x6,5x125	240	5	012410050
1,2x8x150	268	3	012410057
1,6x10x200	325	2	012410066

1242

giravite a battere per viti con impronta a croce Phillips®



UNI/ISO 8764

PHxDxL	L1		
mm	mm		
1x4,5x100	202	5	012420209
2x6x100	215	5	012420218
3x8x150	268	3	012420221
4x11x200	325	2	012420224

1243/D7

serie di 7 giravite a battere



1243/D7 1 012430017

1241	1x5,5x100-1,2x6,5x125 1,2x8x150-1,6x10x200 mm
1242	PH1x4,5x100-PH2x6x100 PH3x8x150 mm

1250

giravite prensili per viti a testa con intaglio



SxDxL	L1		
mm	mm		
0,5x3x125	190	5	012500030
0,6x4x125	225	5	012500040
0,7x5x150	255	5	012500050

1251

giravite prensili per viti con impronta a croce Phillips®



PHxDxL	L1		
mm	mm		
0x4x125	225	5	012510000
1x5x150	255	5	012510010
2x6x175	280	5	012510020

1252/S5



1252/S5 1 012520001

1250	0,5x3x125-0,6x4x125 0,7x5x150 mm
1251	PH1x5x150-PH2x6x175 mm

1253

giravite cercafase 150/250V



SxAxL	L1		
mm	mm		
0,5x3,5x100	190	5	012530001

1253A

giravite cercafase 125/250V doppio isolamento



SxAxL	L1		
mm	mm		
0,5x3x15	150	5	012530010

1254

giravite provacircuito 6÷24V



SxAxL	L1		
mm	mm		
0,5x3x44	123	5	012540001

1256/C36-2

microgiravite con 36 inserti intercambiabili da 4 mm e prolunga magnetica



1256/C36-2 1 012560100

1256TX	T3 - T4 - T5 - T6 - T7 T8 - T9 - T10 - T15
1256RTX	T6 - T7 - T8 - T9 - T10
1256LP	0,8 - 1,2 - 1,5 - 1,8 - 2 - 2,5 3 - 3,5 - 4 mm
1256PE	0,7 - 0,9 - 1,3 - 1,5 - 2 mm
1256PH	PH000 - PH00 - PH0 - PH1
1256PZ	PZ000 - PZ00 - PZ0 - PZ1
1256/20	
1256/30	

130x60x35 mm - 110 g

1256LP

inserti 4 mm
per viti a testa con intaglio

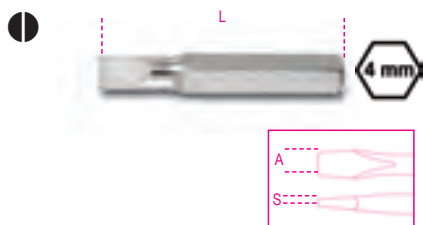

SxA mm	L mm		
0.25x0.8	27	5	012560001
0.25x1.2	27	5	012560002
0.3x1.5	27	5	012560003
0.35x1.8	27	5	012560004
0.4x2.0	27	5	012560005
0.4x2.5	27	5	012560006
0.5x3.0	27	5	012560007
0.6x3.5	27	5	012560008
0.8x4.0	27	5	012560009

1256PH

inserti 4 mm
per viti con impronta Phillips®



PH	L mm		
000	27	5	012560011
00	27	5	012560012
0	27	5	012560013
1	27	5	012560014

1256PZ

inserti 4 mm
per viti con impronta Pozidriv® - Supradriv®



PZ	L mm		
000	27	5	012560061
00	27	5	012560062
0	27	5	012560063
1	27	5	012560064

1256PE

inserti 4 mm
per viti con impronta esagonale



mm	L mm		
0.7	27	5	012560021
0.9	27	5	012560022
1.3	27	5	012560023
1.5	27	5	012560024
2.0	27	5	012560025

1256TX

inserti 4 mm
per viti con impronta Torx®



	L mm		
T3	27	5	012560041
T4	27	5	012560042
T5	27	5	012560043
T6	27	5	012560044
T7	27	5	012560045
T8	27	5	012560046
T9	27	5	012560047
T10	27	5	012560048
T15	27	5	012560049

1256RTX

inserti 4 mm
per viti con impronta Tamper Resistant Torx®



	L mm		
T6	27	5	012560051
T7	27	5	012560052
T8	27	5	012560053
T9	27	5	012560054
T10	27	5	012560055

1256/20

prolunga con attacchi esagonali
maschio e femmina da 4 mm



1256/20 5 012560092

1256/30

portainseri da 4 mm con impugnatura



L
mm
110 2 012560097

1257LP

microgiravite per viti senza testa
con intaglio



SxD mm	L mm		
0,2x1,2	60	5	012570012
0,25x1,5	60	5	012570015
0,3x1,8	60	5	012570018
0,4x2	60	5	012570020
0,4x2,5	60	5	012570024
0,5x3	60	5	012570030
0,6x3,5	60	5	012570035
0,8x4	60	5	012570040



1257LP/S8 1 012570200
0,2x1,2-0,25x1,5
0,3x1,8-0,4x2-0,4x2,5
0,5x3-0,6x3,5-0,8x4 mm

1257PH

microgiravite per viti
con impronta a croce Phillips®



PH	L mm		
00	60	5	012570060
0	60	5	012570063
1	60	5	012570066

1257LPH/S8



1257LPH/S8 1 012570210
1257PH PH00-PH0-PH1
1257LP 0,4x2-0,4x2,5-0,5x3
0,6x3,5-0,8x4 mm

1257ES

microgiravite a chiave maschio
esagonale



mm	L mm		
0,9	60	5	012570045
1,3	60	5	012570046
1,5	60	5	012570047
2	60	5	012570048
2,5	60	5	012570049
3	60	5	012570050

1257ESB/S8



	1257ESB/S8	1	012570230
1257ES	0,9-1,3-1,5-2-2,5-3 mm		
1257BE	4-5 mm		

1257TX

microgiravite a chiave maschio per viti con impronta Torx®



	L mm		
T5	60	5	012570075
T6	60	5	012570076
T7	60	5	012570077
T8	60	5	012570078
T9	60	5	012570079
T10	60	5	012570080
T15	60	5	012570081
T20	60	5	012570082



	1257TX/S8	1	012570220
T5-T6-T7-T8			
T9-T10-T15-T20			

1257BE

microgiravite chiave bussola esagonale



	L mm		
3,2	60	5	012570085
4	60	5	012570086
5	60	5	012570087
5,5	60	5	012570088

1260

giravite per viti a testa con intaglio

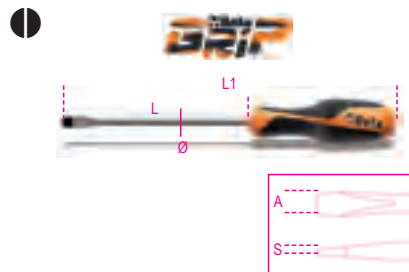

ISO 2380

SxAxL mm	L1 mm	Ø mm		
0,4x2,5x50	150	2,5	5	012600003
0,4x2,5x75	175	2,5	5	012600006
0,5x3x75	175	3,0	5	012600009
0,5x3x100	200	3,0	5	012600012
0,6x3,5x75	175	3,5	5	012600018
0,6x3,5x100	200	3,5	5	012600021
0,8x4x100	208	4,0	5	012600030
0,8x4x125	233	4,0	5	012600033
0,8x4x150	258	4,0	5	012600036
1x5,5x100	208	5,0	5	012600039
1x5,5x125	233	5,0	5	012600040
1x5,5x150	258	5,0	5	012600042
1,2x6,5x100	219	6,0	5	012600048
1,2x6,5x125	244	6,0	5	012600050
1,2x6,5x150	269	6,0	5	012600051
1,2x8x150	277	8,0	3	012600057
1,2x8x200	327	8,0	3	012600060
1,6x10x200	327	9,5	3	012600066
2x12x250	377	10	3	012600069



	1260/S6	1	012600306
0,4x2,5x75-0,5x3x75-0,8x4x125			
1x5,5x150-1,2x6,5x150-1,2x8x200 mm			

1260N

giravite per viti a testa con intaglio tipo cortissimo



ISO 2380

SxAxL mm	L1 mm	Ø mm		
0,8x4x30	87	4	5	012600103
1,2x6,5x30	87	6	5	012600106



1260E

giravite con esagono di manovra per viti a testa con intaglio



ISO 2380

SxAxL mm	L1 mm	Ø mm		
1,2x6,5x150	269	6,0	3	012600156
1,2x8x175	301	8,0	3	012600157
1,6x10x200	327	9,5	2	012600159
2x12x250	377	9,5	2	012600162

1262

giravite per viti con impronta a croce Phillips®



UNI/ISO 8764

PHxDxL mm	L1 mm		
0x3x60	160	5	012620003
0x3x100	200	5	012620006
1x4,5x80	188	5	012620009
1x4,5x120	228	5	012620012
2x6x100	219	5	012620018
2x6x150	269	5	012620021
3x8x150	277	3	012620024
4x10x200	327	3	012620027



	1262/S4	1	012620304
PH0x3x60-PH1x4,5x80			
PH2x6x100-PH3x8x150 mm			

1262N

giravite per viti con impronta a croce Phillips® tipo cortissimo



UNI/ISO 8764

PHxDxL mm	L1 mm		
1x4,5x30	87	5	012620103
2x6x30	87	5	012620106

1262E

giravite con esagono di manovra per viti con impronta a croce Phillips®



UNI/ISO 8764

PHxDxL mm	L1 mm		
2x6x150	269	3	012620153
3x8x175	302	3	012620156
4x10x200	327	2	012620159

1262L

giravite per viti con impronta a croce Phillips®, tipo lungo



UNI/ISO 8764-1

PHxDxL mm	L1 mm		
0x3x300	400	3	012620203
1x4,5x300	400	3	012620205
1x4,5x400	508	3	012620206
2x6x400	519	3	012620209

1263/D...

serie giravite



1263/D6			
1262	PH0x3x60-PH1x4,5x80 PH2x6x100 mm	1	012630006
1264	0,5x2,5x60-0,6x3x100 0,8x4x125-1x5x125 mm		



1263/D7			
1262	PH0x3x60-PH1x4,5x80 PH2x6x100 mm	1	012630017
1264	0,5x2,5x60-0,6x3x100 0,8x4x125-1x5x125 mm		



1263/D7PZ			
1260	0,5x3x75-0,8x4x100 1x5,5x150-1,2x6,5x150 mm	1	012630007
1269PZ	PZO - PZ1 - PZ2		



1263/D8			
1260	0,4x2,5x50-0,5x3x75 0,8x4x100-1x5,5x125 1,2x6,5x150 mm	1	012630008
1262	PH0x3x60-PH1x4,5x80 PH2x6x100 mm		



1263/D10			
1260	0,5x3x75-0,6x3,5x100 0,8x4x125-1x5,5x150 1,2x6,5x150 mm	1	012630010
1260N	0,8x4x30		
1262	PH0x3x60-PH1x4,5x80 PH2x6x100 mm		
1262N	PH1x4,5x30		

1263/S12

serie di 12 giravite



1263/S12			
1260	0,4x2,5x50-0,5x3x75 0,6x3,5x100-0,8x4x125 1x5,5x125-1,2x6,5x150 1,2x8x200-1,6x10x200 mm	3	012630112
1262	PH0x3x60-PH1x4,5x80 PH2x6x100-PH3x8x150 mm		

1264

giravite per viti senza testa con intaglio tipo lungo



SxDxL mm	L1 mm		
0,5x2,5x60	160	5	012640003
0,6x3x75	175	5	012640006
0,6x3x100	200	5	012640009
0,8x4x100	208	5	012640012
0,8x4x125	233	5	012640015
1x5x125	233	5	012640018
1x5x150	258	5	012640021
1,2x6,5x150	269	5	012640024



1264/S5

0,5x2,5x60-0,6x3x75
0,8x4x100-1x5x125-1,2x6,5x150 mm

1 012640305

1264L

giravite per viti senza testa con intaglio tipo lungo



SxDxL mm	L1 mm		
0,5x2,5x200	300	3	012640203
0,6x3x300	400	3	012640206
0,8x4x400	508	3	012640209
1x5x400	508	3	012640215
1,2x6,5x400	519	3	012640218

1265ES

chiavi maschio esagonale con impugnatura



mm	L mm	L1 mm		
1,5	100	200	3	012650015
2	100	200	3	012650020
2,5	100	200	3	012650025
3	100	200	3	012650030
4	100	208	3	012650040
5	100	219	3	012650050
6	125	244	3	012650060
8	150	277	2	012650080



1265ES/S8

1,5-2-2,5-3-4-5-6-8 mm

1 012650308

1266BP

chiavi maschio esagonale
ad estremità sferica con impugnatura



mm	L mm	L1 mm		
2	100	200	3	012660020
2,5	100	200	3	012660025
3	125	225	3	012660030
4	125	233	3	012660040
5	120	239	3	012660050
6	140	259	3	012660060
8	160	287	2	012660080
10	160	287	2	012660100



1266BP/S8
2-2,5-3-4-5-6-8-10 mm

1267TX

chiavi maschio con impugnatura
per viti con impronta Torx®



	L mm	L1 mm	Ø mm		
T5	50	150	3	5	012670005
T6	50	150	3	5	012670006
T7	50	150	3	5	012670007
T8	60	160	3	5	012670008
T9	60	167	4	5	012670009
T10	80	188	4	5	012670010
T15	80	188	4	5	012670015
T20	100	208	4,5	5	012670020
T25	100	208	5	5	012670025
T27	115	234	6	5	012670027
T30	115	234	6	5	012670030
T40	130	257	7	2	012670040
T45	130	257	8	2	012670045



1267TX/D7
T6-T8-T10-T15
T20-T25-T30



1267TX/S13
T5-T6-T7-T8-T9
T10-T15-T20-T25
T27-T30-T40-T45

1268RTX

chiavi maschio con impugnatura
per viti con impronta
Tamper Resistant Torx®



	L mm	L1 mm	Ø mm		
T9	60	167	4,0	3	012680009
T10	80	188	4,0	3	012680010
T15	80	188	4,0	3	012680015
T20	100	208	4,5	3	012680020
T25	100	208	5,0	3	012680025
T27	115	234	6,0	3	012680027
T30	115	234	6,0	3	012680030
T40	130	257	7,0	2	012680040



1268RTX/S8
T9-T10-T15-T20
T25-T27-T30-T40

1269PZ

giravite per viti con impronta
a croce Pozidriv®-Supadriv®



UNI/ISO 8764

PZ	L mm	L1 mm		
0	60	160	5	012690000
1	80	188	5	012690001
2	100	219	5	012690002
3	150	277	3	012690003
4	200	327	3	012690004



1269PZ/S4
PZ0-PZ1-PZ2-PZ3

1269N/PZ

giravite per viti con impronta
a croce Pozidriv®-Supadriv®
tipo cortissimo



UNI/ISO 8764

PZ	L mm	L1 mm		
1	30	87	5	012690011
2	30	87	5	012690012

1281BG

impugnatura porta lame giravite



L
mm 118

1281PM

portainserti magnetico
ad innesto rapido



L
mm 165

1281PB

portabussole quadro maschio 1/4"



L
mm 175

1281LP

giravite bivalenti per viti
a testa con intaglio

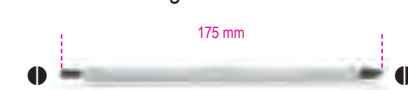

1281LP/1
0,8x4-1,2x6,5 mm

1281LP/2
1x5,5-1,2x6,5 mm

1281PH

giravite bivalenti per viti con impronta a croce Phillips®



PH		
1-2	5	012810310
2-3	5	012810312

1281LPH

giravite bivalenti per viti a testa con intaglio e Phillips®



1281LPH/1	5	012810321
PH0-0,8x4 mm		
1281LPH/2	5	012810322
PH1-1x5,5 mm		
1281LPH/3	5	012810323
PH2-1,2x6,5 mm		

1281PZ

giravite bivalenti per viti con impronta a croce Pozidriv®-Supadriv®



PZ		
1-2	5	012810330
2-3	5	012810332

1281PE

chiavi maschio esagonale bivalenti con un'estremità sferica



mm		
2,5	5	012810342
3	5	012810343
4	5	012810344
5	5	012810345
6	5	012810346

1281TX

chiavi maschio bivalenti per viti con impronta Torx®



1281TX/1	5	012810349
T6-T8		
1281TX/2	5	012810350
T7-T9		
1281TX/3	5	012810351
T10-T15		
1281TX/4	5	012810352
T20-T25		
1281TX/5	5	012810353
T30-T40		

1281RTX

chiavi maschio bivalenti per viti con impronta Tamper Resistant Torx®



1281RTX/3	5	012810361
T10-T15		
1281RTX/4	5	012810362
T20-T25		
1281RTX/5	5	012810363
T30-T40		

1281BG/A9

assortimento di 9 giravite bivalenti e 1 impugnatura di manovra, in astuccio



1281BG/A9	1	012810520
-----------	---	-----------

1281BG		
+	1281LPH/1	PH0-0,8x4 mm
●		
+	1281LPH/2	PH1-1x5,5 mm
●		
+	1281LPH/3	PH2-1,2x6,5 mm
●		
+	1281PZ/1	PZ1-PZ2
○	1281PE	2,5 mm
○	1281PE	3 mm
○	1281PE	4 mm
○	1281PE	5 mm
○	1281PE	6 mm

1281BG-TX/A8

assortimento di 8 giravite bivalenti e 1 impugnatura di manovra, in astuccio



1281BG-TX/A8	1	012810530
--------------	---	-----------

1281BG		
+	1281LPH/1	PH0-0,8x4 mm
●		
+	1281LPH/2	PH1-1x5,5 mm
●		
+	1281LPH/3	PH2-1,2x6,5 mm
●		
○	1281TX/1	T6-T8
○	1281TX/2	T7-T9
○	1281TX/3	T10-T15
○	1281TX/4	T20-T25
○	1281TX/5	T30-T40

1281BG/B28A

assortimento di 16 giravite bivalenti, 9 chiavi a bussola 1/4", 2 accessori e 1 impugnatura di manovra, in busta



1281BG/B28A	1	012810510
-------------	---	-----------

○ 900	4 - 4,5 - 5 - 5,5 6 - 7 - 8 - 9 - 10 mm
1281BG	
1281PB	■ 1/4
900/25	
●	1281LP/1 0,8x4 - 1,2x6,5 mm
●	1281LP/2 1,0x5,5 - 1,2x6,5 mm
+	1281PH/1 PH1 - PH2
+	1281PH/2 PH2 - PH3
+	1281PZ/1 PZ1 - PZ2
+	1281PZ/2 PZ2 - PZ3
○	1281PE 2,5 - 3 - 4 - 5 - 6 mm
○	1281TX/1 T6 - T8
○	1281TX/2 T7 - T9
○	1281RTX/3 T10 - T15
○	1281RTX/4 T20 - T25
○	1281RTX/5 T30 - T40

1281/BV	1	012810501
---------	---	-----------

1290

giravite per viti a testa con intaglio



ISO 2380

SxAxL mm	L1 mm	Ø mm	
0,4x2,5x50	146	2,5	5 012900003
0,4x2,5x75	171	2,5	5 012900006
0,5x3x75	171	3,0	10 012900009
0,5x3x100	196	3,0	10 012900012
0,6x3,5x75	171	3,5	10 012900018
0,6x3,5x100	196	3,5	10 012900021
0,8x4x100	196	4,0	10 012900030
0,8x4x125	221	4,0	10 012900033
0,8x4x150	246	4,0	10 012900036
1x5,5x100	209	5,0	10 012900039
1x5,5x150	259	5,0	10 012900042
1,2x6,5x100	220	6,0	10 012900048
1,2x6,5x150	270	6,0	10 012900051
1,2x8x150	282	7,0	3 012900057
1,2x8x200	332	7,0	3 012900060
1,6x10x200	332	8,0	3 012900066
2x12x250	382	10	2 012900069

Beta INOX

STAINLESS STEEL



1290/S...

serie giravite



1290/S5	1	012900305
1290	0,5x3x75-0,8x4x100 - 1x5,5x150 1,2x6,5x150 - 1,2x8x150 mm	

1290/S9X	1	012900319
1290	0,4x2,5x75 - 0,5x3,5x100 0,8x4x125 - 1x5,5x150 1,2x6,5x150 - 1,2x8x200 1,6x10x200 mm	
1290N	0,8x4x30 - 1,2x6,5x30 mm	

1290N

giravite per viti a testa con intaglio
tipo cortissimo



SxAL	L1	Ø		
mm	mm	mm		
0,8x4x30	86	4	5	012900103
1,2x6,5x30	86	6	5	012900106

1292

giravite per viti
con impronta a croce Phillips®

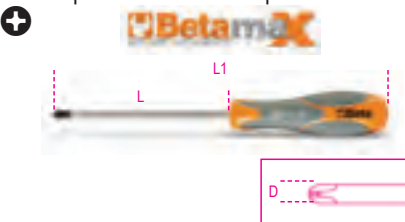

PHxDxL	L1		
mm	mm		
0x3x60	156	10	012920003
0x3x100	196	5	012920006
1x4,5x80	189	10	012920009
1x4,5x120	229	10	012920012
2x6x100	220	10	012920018
2x6x150	270	10	012920021
3x8x150	282	3	012920024
4x10x200	332	3	012920027



1292/S4	1	012920304
PH0x3x60-PH1x4,5x80 PH2x6x100-PH3x8x150 mm		

1292N

giravite per viti con impronta
a croce Phillips®
tipo cortissimo



PHxDxL	L1		
mm	mm		
1x4,5x30	86	5	012920103
2x6x30	86	5	012920106

1292L

giravite per viti con impronta
a croce Phillips®, tipo lungo

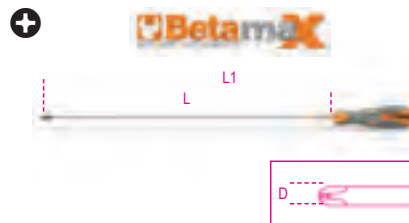

PHxDxL	L1		
mm	mm		
0x3x300	396	3	012920203
1x4,5x400	509	3	012920206
2x6x400	520	3	012920209



1293/D...

serie giravite



1293/D6	1	012930401
1290	0,6x3,5x75-1x5,5x150 1,2x6,5x150 mm	
1292	PH0x3x60 -PH1x4,5x80 PH2x6x100 mm	

1293/D8	1	012930403
1290	0,5x3x75-0,8x4x100 1x5,5x150-1,2x6,5x150 1,2x8x150 mm	
1292	PH0x3x60 -PH1x4,5x80 PH2x6x100 mm	

1293/S...

serie giravite



1293/S10	1	012930201
1290	0,4x2,5x50 -0,6x3,5x100 1x5,5x100-1,2x6,5x150 1,2x8x150-1,6x10x200 mm	
1292	PH0x3x60 -PH1x4,5x80 PH2x6x100-PH3x8x150 mm	

1293/S12	1	012930203
1290	0,5x3x75-0,8x4x125 1x5,5x150-1,2x6,5x150 1,2x8x200 mm	
1290N	0,8x4x30 mm	
1292	PH0x3x60 -PH1x4,5x80 PH2x6x100-PH3x8x150 mm	
1292N	PH1x4,5x30-PH2x6x30 mm	

1293/S7	1	012930207
1292	PH0x3x60 -PH1x4,5x80 PH2x6x100 mm	
1294	0,5x2,5x60-0,6x3x75 0,8x4x100-1x5x125 mm	

1293ES

chiavi maschio esagonale
con impugnatura



mm	L	L1	Ø		
mm	mm	mm	mm		
2	100	196	3	5	012930001
2,5	100	196	4	5	012930002
3	100	196	4	5	012930003

mm	L mm	L1 mm	Ø mm		
4	100	196	5	5	012930004
5	100	209	6	5	012930005
6	125	245	7	5	012930006
8	150	282	10	2	012930008



1293ES/S7	1	012930057
2-2,5-3-4-5-6-8 mm		

1293BP

chiavi maschio esagonale ad estremità sferica con impugnatura



mm	L mm	L1 mm		
2	100	196	5	012930501
2,5	100	196	5	012930502
3	100	196	5	012930503
4	100	196	5	012930506
5	100	209	5	012930509
6	125	245	5	012930512
8	150	282	2	012930515



1293BP/S7	1	012930558
2-2,5-3-4-5-6-8 mm		

1294

giravite per viti senza testa con intaglio con intaglio



SxDxL mm	L1 mm		
0,5x2,5x60	156	5	012940003
0,6x3x75	171	5	012940006
0,6x3x100	196	5	012940009
0,8x4x100	196	5	012940012
0,8x4x150	246	5	012940015
1x5x125	234	5	012940018
1,2x6,5x150	282	5	012940027



1294/S5	1	012940305
----------------	---	-----------

0,5x2,5x60-0,6x3x100
0,8x4x100-1x5x125
1,2x6,5x150 mm

1294L

giravite per viti senza testa con intaglio tipo lungo



SxDxL mm	L1 mm		
0,6x3x300	396	3	012940206
0,8x4x400	496	3	012940209
1x5x400	509	3	012940215
1,2x6,5x400	532	3	012940218

1295

giravite a percussione



L mm	130	1	012950001
---------	-----	---	-----------

1295/C14

giravite a percussione con 14 inserti e bussola portainseri



1295/C14	1	012950108
-----------------	---	-----------

● 866LP	1,2x6,5 - 1,6x10 mm
⊕ 866PH	PH2 - PH3
⊕ 866PZ	PZ2 - PZ3
○ 866PE	5 - 6 mm
⊗ 866TX	T27 - T30 - T40 - T45 - T50 - T55
895/6	□ 1/2 - ○ 5/16
1295	■ 1/2

170x100x35 mm - 1,3 kg

1297TX

chiavi maschio con impugnatura per viti con impronta Torx®



	L mm	L1 mm	Ø mm		
T6	50	146	3,0	5	012970006
T7	50	146	3,0	5	012970007
T8	60	156	3,0	5	012970008
T9	60	169	4,0	5	012970009
T10	80	189	4,0	5	012970010
T15	80	189	4,0	5	012970015
T20	100	209	4,5	5	012970020
T25	100	209	5,0	5	012970025
T27	115	235	6,0	5	012970027
T30	115	235	6,0	5	012970030
T40	130	262	7,0	2	012970040
T45	130	262	8,0	2	012970045



1297TX/S12	1	012970312
-------------------	---	-----------

T6-T7-T8-T9-T10
T15-T20-T25-T27
T30-T40-T45



1297TX/D6	1	012970409
------------------	---	-----------

T10-T15-T20
T25-T27-T30

1298RTX

chiavi maschio con impugnatura per viti con impronta Tamper Resistant Torx®



	L mm	L1 mm	Ø mm		
T9	60	169	4,0	5	012980009
T10	80	189	4,0	5	012980010
T15	80	189	4,0	5	012980015
T20	100	209	4,0	5	012980020
T25	100	209	4,5	5	012980025
T27	115	235	5,5	5	012980027
T30	115	235	6,0	5	012980030
T40	130	262	7,0	2	012980040



1298RTX/S8
T9-T10-T15-T20
T25-T27-T30-T40

1 012980308

1299PZ

giravite per viti con impronta a croce Pozidriv®-Supadriv®



UNI/ISO 8764

PZ	L mm	L1 mm		
0	60	156	5	012990000
1	80	189	5	012990003
2	100	220	5	012990006
3	150	282	2	012990009
4	200	332	2	012990012



1299PZ/S6
1299PZ PZ0-PZ1-PZ2-PZ3
1299N/PZ PZ1-PZ2

1 012990306

1299N/PZ

giravite per viti con impronta a croce Pozidriv®-Supadriv® tipo cortissimo



UNI/ISO 8764

PZ	L mm	L1 mm		
1	30	86	5	012990021
2	30	86	5	012990024

1302

tasso con impugnatura testa tonda convessa e a penna



770 1 013020001

1303

tasso a virgola



1350 1 013030001

1304

tasso a suola



875 1 013040001

1305

tasso curvo



1190 1 013050001

1305Z

tasso curvo zigrinato



1065 1 013050002

1306

tasso a tacco bombato



1040 1 013060001

1307

tasso rettangolare bombato

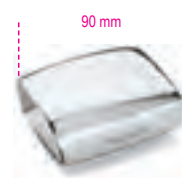

1100 1 013070001

1308

tasso ovoidale



1100 1 013080001

1309

tasso a doppia penna



460 1 013090001

1310

tasso a rotaiia



1225 1 013100001

1312

tasso a incudine



1220 1 013120001

1313

tasso a tampone



g 990 1 013130001

1314

tasso a teste tonde
convessa e piana



g 760 1 013140001

1326

leva a cazzuola



g 560 1 013260001

1327

leva a cucchiaio
pesante



g 1075 1 013270001

1328

leva a cucchiaio
leggera



g 935 1 013280001

1329

leva curva e piana



g 1800 1 013290001

1330

leva a gomito e piana



g 2125 1 013300001

1331

leva a gola con linguetta in cuoio

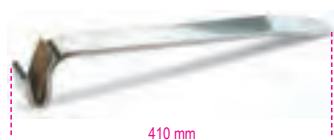

g 1100 1 013310001

1335BM

battilamiera con impugnatura
in materiale plastico



g 500 2 013350010

1337/S5

serie di 5 spatoline per carrozzieri in acciaio
inox tipo giapponese



L mm 25-50-75-100-125 1 013370015

1338A - 1338B

portalima con lima
a dentatura radiale, piatta flessibile



g 1338A 9 360 2 013380001
1338B 12 360 2 013380002

1338

portalima per 1338R



1338 2 013380003

1338R9 - 1338R12

lime di ricambio per 1338A e 1338B



1338R9 9 2 013380004
1338R12 12 2 013380005

1342

scalpello extrapiatto
con tagliente diritto



L mm 235 5 013420001

1342PM

scalpello extrapiatto con tagliente diritto
con paramano

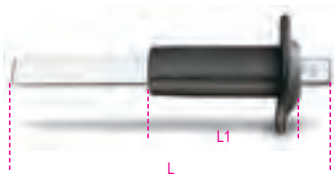

L mm 235 L1 mm 118 2 013420002

1342PMR

paramano di ricambio per 1342



1342PMR 1 013420003

1343

scalpello piatto con tagliente laterale



L mm 200 5 013430001

1345

martello con testa tonda convessa e penna
manico in legno



1345 2 013450010

1351

martello con testa tonda piana e penna sferica
manico in legno



1351 2 013510010

1353

martello con testa tonda piana e penna a punta
manico in legno



1353 2 013530010

1357Z/45

martelli con teste piane tonda zigrinata e quadra liscia
manico in legno



1357 Z/45 2 013570045

1359T

martello con testa tonda convessa e penna orizzontale
manico in legno

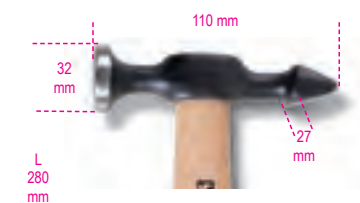

1359 T 2 013590010

1368

kit ripara plastiche

• permette di riparare velocemente crepe e rotture di parti in plastica

Alimentazione: 220+240 V con presa Shuko
Lunghezza cavo pistola termica: 3,5 m
Lunghezza cavo alimentazione: 1,35 m
2 regolazioni di potenza: 35-75 W
Pistola termica con terminali in ottone a 2 angolazioni di inserimento graffetta: 0°-90°
Protezione input: disgiuntore termico
Protezione output: fusibile 10 A
Tasca metallica per riporre la pistola



1368 1 013680001

1368G/OD

graffette ondulate dritte per 1368



1368 G/OD 1 013680100

I prezzi indicati sono relativi a 100 pezzi

1368G/SD

graffette a spirale dritte per 1368



1368 G/SD 1 013680110

I prezzi indicati sono relativi a 100 pezzi

1368G/CV

graffette per angoli convessi per 1368



1368 G/CV 1 013680120

I prezzi indicati sono relativi a 100 pezzi

1368G/C2U

graffette per angoli concavi per 1368



1368 G/C2U 1 013680130

I prezzi indicati sono relativi a 100 pezzi

1369/C11

assortimento di 11 utensili



1369 /C11 1 013690033



470x340x70 mm - 15,2 kg

1370

martelli tipo tedesco per meccanici
manico in legno



UNI 7778 DIN 1041

g	A mm	L mm	L1 mm	
100	15	260	82	5 013700051
200	19	280	95	5 013700052
300	23	300	105	5 013700053
400	25	310	112	5 013700054
500	27	320	118	5 013700055
600	30	330	122	5 013700056
800	33	350	130	4 013700058
1000	36	360	135	4 013700060
1500	42	380	145	2 013700065
2000	47	400	155	1 013700070



1370/MR...

manici di ricambio per 1370



1370/MR100 1370/100	4	013700081
1370/MR200 1370/200	4	013700082
1370/MR300 1370/300	4	013700083
1370/MR400 1370/400	4	013700084
1370/MR500 1370/500	4	013700085
1370/MR600 1370/600	4	013700086
1370/MR800 1370/800	4	013700088
1370/MR1000 1370/1000	4	013700090
1370/MR1500 1370/1500	4	013700095
1370/MR2000 1370/2000	4	013700100

1370T

martelli tipo tedesco
per meccanici
manico in fibra



g	A mm	L mm	L1 mm		
200	19	280	95	5	013700620
300	23	300	105	5	013700630
500	27	320	118	5	013700650
800	33	350	130	4	013700680
1000	36	360	135	4	013700700
1500	42	365	145	2	013700750

1370F

martelli tipo francese
per meccanici
manico in legno



NF E 71.014

A mm	L mm	L1 mm	g		
24	260	77	280	2	013700424
26	260	80	310	2	013700426
28	280	86	400	2	013700428
30	280	92	450	2	013700430
32	300	100	550	2	013700432
36	300	104	720	2	013700436
40	330	110	1065	2	013700440
42	330	116	1080	2	013700442
50	380	138	1760	2	013700450
60	380	160	2585	2	013700460

1370F/MR...

manici di ricambio per 1370F



1370F/MR24 1370F/24-26	2	013700474
1370F/MR28 1370F/28-30	2	013700478
1370F/MR32 1370F/32-36	2	013700482
1370F/MR40 1370F/40-42	2	013700490
1370F/MR50 1370F/50	2	013700495
1370F/MR60 1370F/60	2	013700496

1370FT

martelli tipo francese per meccanici,
manico in fibra

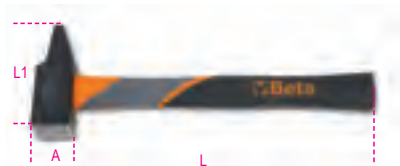

A mm	L mm	L1 mm	g		
28	280	86	530	1	013700528
30	280	92	625	1	013700530
32	300	100	750	1	013700532
36	300	104	930	1	013700536
40	330	110	1150	1	013700540
42	330	116	1250	1	013700542
50	380	138	2100	1	013700550
60	380	160	2750	1	013700560

1374F

martelli tipo francese
per falegnami
manico in legno



NF E 71.012

A mm	L mm	L1 mm	g		
16	250	80	180	2	013740416
20	270	86	250	2	013740420
22	290	92	335	2	013740422
26	290	103	425	2	013740426
28	310	108	510	2	013740428
30	310	117	580	2	013740430

1374F/MR...

manici di ricambio per 1374F



1374F/MR16 1374F/16	2	013740456
1374F/MR20 1374F/20	2	013740460
1374F/MR22 1374F/22-26	2	013740462
1374F/MR28 1374F/28	2	013740468
1374F/MR30 1374F/30	2	013740470

1375

martello con penna
a granchio
manico in legno



g	L1 mm	Ø mm	L mm		
300	95	25	300	3	013750000

1375/MR

manici di ricambio per 1375



1375/MR	2	013750003
---------	---	-----------

1375A

martelli con penna
a granchio
manico in materiale plastico



oz	g	L mm	L1 mm		
16	450	330	130	3	013750016
20	570	330	130	3	013750020

1375B

martelli con penna
a granchio
manico in acciaio



oz	g	L mm	L1 mm		
16	450	330	130	3	013750026
20	570	330	130	3	013750030

1376X

martelli a testa quadra,
con sede portachiodo e calamita,
penna a granchio, per carpentieri
manico in legno



g	A mm	L1 mm	L mm		
250	20	125	450	3	013760125
300	25	130	450	3	013760130
400	27	132	450	3	013760140

1376X/MR

manico di ricambio
per 1376X



1376X/MR

2 013760161

1376XT

martelli a testa quadra,
con sede portachiodo e calamita,
penna a granchio, per carpentieri
manico in materiale plastico



g	A	L1	L	
mm	mm	mm	mm	
250	20	125	500	3 013760525
300	25	130	500	3 013760530
400	27	132	500	3 013760540

1376XT/MR

manico di ricambio
per 1376XT



1376XT/MR

2 013760585

1377

martelli con testa tonda
e penna sferica
per calderai e lattonieri
manico in legno



HICKORY

g	L	L1	
mm	mm	mm	
340	330	95	2 013770134
450	350	102	2 013770145
570	350	110	2 013770157
680	360	116	2 013770168
900	380	120	2 013770190

1377/MR...

manici di ricambio per 1377



1377/MR340 1377/340	2 013770234
1377/MR450 1377/450	2 013770245
1377/MR570 1377/570	2 013770257
1377/MR680 1377/680	2 013770268
1377/MR900 1377/900	2 013770290

1378

martelli con testa tonda
e penna simmetrica
per calderai e lattonieri
manico in legno



HICKORY

g	L	L1	Ø	
mm	mm	mm	mm	
340	330	100	27	2 013780134
570	350	115	32	2 013780157

1378/MR...

manici di ricambio per 1378



1378/MR340 1378/340	2 013780234
1378/MR570 1378/570	2 013780257

1379F

martelli tipo francese
per elettricisti
manico in legno

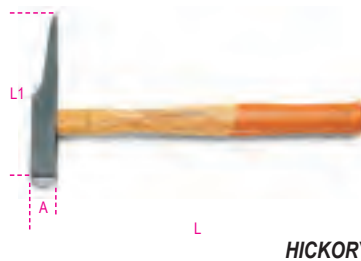

HICKORY

NF E 71.011

A	L	L1	
mm	mm	mm	
16	250	126	2 013790416
18	250	135	2 013790418
20	260	142	2 013790420

1379F/MR...

manici di ricambio per 1379F



1379F/MR16 1379F/16-18	2 013790426
1379F/MR20 1379F/20	2 013790430

 Beta

 Beta

1380

mazzette
manico in legno



HICKORY

UNI 7777 DIN 6475

g	A	L	L1	
mm	mm	mm	mm	
800	38	260	90	2 013800208
1000	40	260	95	2 013800210
1250	43	260	100	2 013800212
1500	45	280	110	2 013800215
2000	50	300	120	2 013800220

1380/MR...

manici di ricambio per 1380



1380/MR800 1380/800-1000-1250	2 013800238
1380/MR1500 1380/1500	2 013800245
1380/MR2000 1380/2000	2 013800250

1380S

mazzette con collare salvamanico
manico in legno
collare in materiale plastico



g	A	L	L1	
mm	mm	mm	mm	
800	36	260	90	2 013800400
1000	39	260	95	2 013800405
1250	43	260	100	2 013800410
1500	45	260	110	2 013800415

1380S/MR...

manici di ricambio per 1380S



1380S/MR800 1380S/800-1000-1250	2 013800417
1380S/MR1500 1380S/1500	2 013800419

1380T

mazzette
manico in fibra



g	A mm	L mm	L1 mm		
800	35	260	85	2	013800308
1000	40	260	100	2	013800310
1250	42	260	110	2	013800312
1500	45	260	120	2	013800315

1381

mazze a coppia
manico in legno hickory

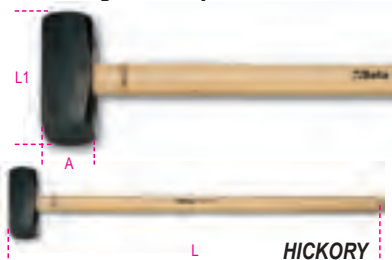

g	A mm	L mm	L1 mm		
3000	55	800	142	1	013810030
4000	60	900	152	1	013810040
5000	70	900	162	1	013810050
8000*	80	900	185	1	013810080

* = manico in frassino

1381/MR...

manici di ricambio per 1381



1381/MR3-4 1381/3000-4000	2	013810730
1381/MR5 1381/5000	2	013810750
1381/MR8 1381/8000	2	013810780

1381T

mazze a coppia
manico in fibra

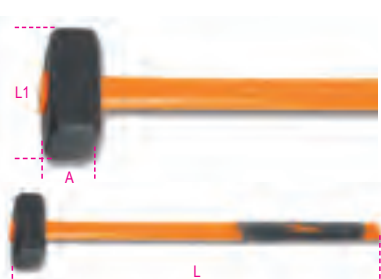

g	A mm	L mm	L1 mm		
3000	55	900	142	1	013810330
4000	60	900	152	1	013810340
5000	70	900	162	1	013810350

1385

mazzuole
con testa in rame
manico in legno



g	A mm	L mm	L1 mm		
400	26	260	75	2	013850404
600	32	270	80	2	013850406
800	34	280	90	2	013850408
1000	37	280	100	2	013850410
1500	43	280	110	2	013850415
2000	48	300	120	1	013850420

1385/MR

manici di ricambio per 1385



1385/MR400 1385 400	2	013850464
1385/MR600 1385 600	2	013850466
1385/MR800 1385 800	2	013850468
1385/MR1000 1385 1000	2	013850470
1385/MR1500 1385 1500	1	013850475
1385/MR2000 1385 2000	1	013850480

1390

mazzuole con battenti intercambiabili
in materiale plastico
manico in legno



UNI 7784

D mm	L mm	L1 mm		
22	260	70	5	013900022
28	280	85	5	013900028
35	310	95	5	013900035
45	320	107	4	013900045
60	380	128	2	013900060

1390/MR...

manici di ricambio per 1390



1390/MR22 1390/22	2	013900222
1390/MR28 1390/28	2	013900228
1390/MR35 1390/35	2	013900235
1390/MR45 1390/45	2	013900245
1390/MR60 1390/60	2	013900260

Beta

1390R

battenti di ricambio per 1390



D mm		
22	4	013900122
28	4	013900128
35	4	013900135
45	4	013900145
60	4	013900160

1390N

mazzuole con battenti intercambiabili in nylon,
manico in legno

Battenti medio-duri: 75 Shore

Resistente all'olio e all'usura

Particolarmente indicato per lavorazioni su lamiera e metalli



D mm	L mm	L1 mm		
22	260	70	3	013900522
28	280	85	3	013900528
35	310	95	3	013900535
45	320	107	2	013900545
60	380	128	2	013900560

1390NR

battenti di ricambio in nylon per 1390N



D mm		
22	4	013900622
28	4	013900628
35	4	013900635
45	4	013900645
60	4	013900660

1391

mazzuole antirimbalo
interamente rivestite in gomma



D mm	L mm	L1 mm		
35	280	90	2	013910135
50	320	105	2	013910150
55	355	110	2	013910155
65	380	130	2	013910165

Beta

1391A

mazzuole per piastrellisti
interamente rivestite in gomma



g	D	L	L1		
mm	mm	mm	mm		
500	45	290	100	2	013910205
1000	60	300	120	2	013910210

1392

mazzuole antirimbalo
con battenti intercambiabili
in materiale plastico
manico in acciaio



D	L	L1		
mm	mm	mm		
30	300	105	2	013920030
35	305	115	2	013920035
40	310	125	2	013920040
50	325	135	2	013920050
60	385	155	2	013920060

1392R

battenti di ricambio per 1392

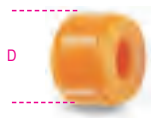

D		
mm		
30	4	013920230
35	4	013920235
40	4	013920240
50	4	013920250
60	4	013920260

1393

mazzuole con testa
in gomma dura



D	L	L1		
mm	mm	mm		
50	315	90	3	013930050
60	340	110	3	013930060
70	370	130	2	013930070

1410/M

attrezzo ad uncino
per trazione molle



Ø		
mm		
3,5	2	014100051

1428

estrattori per dadi danneggiati
con attacco quadro



Ø	L		
mm	mm		
8	3/8	36	2 014280008
10	3/8	36	2 014280010
11	3/8	36	2 014280011
12	3/8	36	2 014280012
13	3/8	36	2 014280013
14	3/8	36	2 014280014
15	1/2	38	2 014280015
16	1/2	38	2 014280016
17	1/2	38	2 014280017
18	1/2	38	2 014280018
19	1/2	38	2 014280019
20	1/2	38	2 014280020
21	1/2	38	2 014280021
22	1/2	38	2 014280022
24	1/2	38	2 014280024
27	1/2	38	2 014280027

38"		
12"		
1428/SB11	1	014280111
8-10-11-12-13-14 15-16-17-18-19 mm		
1428/SB5	1	014280115
20-21-22-24-27 mm		

1428L

estrattori a bussola lunghi
per dadi destrorsi danneggiati
con attacco quadro



Ø		
mm		
17	1	014280217
19	1	014280219
21	1	014280221

12"		
1428L/B3	1	014280303
17-19-21 mm		

1429

estrattori per viti e prigionieri danneggiati
con attacco quadro



mm	Ø	L		
mm	mm	mm		
2	3/8	60	3	014290002
3	3/8	60	3	014290003
4	3/8	60	3	014290004
5	3/8	60	2	014290005
6	3/8	60	2	014290006
8	1/2	70	2	014290008
10	1/2	70	2	014290010

38"		
12"		
1429/SB7	1	014290107
2-3-4-5-6-8-10 mm		

1430/...

estrattori conici per viti
e prigionieri spezzati
in acciaio legato

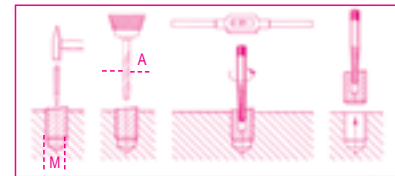

	M	A		
	mm	mm		
1430/1	3÷6	2,5	10	014300006
1430/2	6÷8	3,0	10	014300008
1430/3	8÷11	4,5	10	014300011
1430/4	11÷14	6,0	10	014300014
1430/5	14÷18	8,0	10	014300018
1430/6	18÷24	11,0	5	014300024
1430/7	24÷33	14,0	5	014300033
1430/8	33÷50	21,0	5	014300050



1430/S5	1	014300105
1430/1-1430/2-1430/3 1430/4-1430/5		
1430/S6	1	014300106
1430/1-1430/2-1430/3 1430/4-1430/5-1430/6		
1430/S8	1	014300108
1430/1-1430/2-1430/3 1430/4-1430/5-1430/6 1430/7-1430/8		

1433

estrattori a rulli
per viti prigioniere

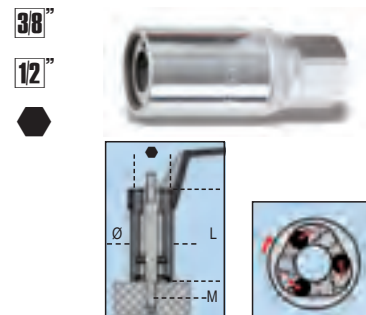

M	Ø	L	●		
mm	mm	mm	mm		
5	21	60	19	2	014330005
6	24	60	21	2	014330006
7	24	60	21	2	014330007
8	24	60	21	2	014330008

M	Ø	L	●	
mm	mm	mm	mm	
9	28	70	21	2 014330009
10	28	70	21	2 014330010
10,5	28	70	21	2 014330021
11	28	70	21	2 014330011
12	28	70	21	2 014330012
14	36	72	24	2 014330014
16	36	72	24	2 014330016

1433/C11

estrattori a rulli
per viti prigioniere



1433/C11 1 014330311

M5 - M6 - M7 - M8 - M9 - M10 - M10,5
M11 - M12 - M14 - M16

340x135x56 mm - 3,0 kg

1435

estrattore ad eccentrico
per viti prigioniere



Ø mm 4÷20 1 014350001

1435R

rotella di ricambio per 1435



1435R 1 014350010

1435/1

estrattore ad eccentrico
per viti prigioniere



Ø mm 19÷26 1 014350002

1435/1R

rotella di ricambio per 1435/1



1435/1R 1 014350011

1437/C12

assortimento 12 utensili per rimozione air bag



1437/C12 1 014370001

260x160x55 mm - 1,0 kg

1438

attrezzo universale
per centraggio frizioni
completo di 3 coni ad espansione



1438 1 014380001

1438R

coni ad espansione
di ricambio per 1438



Ø mm	
14÷18	5 014380101
18÷21	5 014380102
22÷25	5 014380103

1438 SAC

Kit centraggio frizioni SAC

- incluso kit per applicazioni senza cuscinetti di guida
- fornito con piastre a 3 e 4 bracci



1438 SAC 1 014380050

480x380x130 mm - 9,5 kg

1439/K7

cassetta giravite angolare 90° tipo lungo
con lame



Dotazione valigetta:

- Giravite angolare
- 1 Testa per viti ad intaglio
- 1 Testa per bits 1/4
- 1 Testa per lame speciali
- 7 lame speciali

1439/K7 1 014390101

500x120x60 mm 825 g

1440/...

attrezzi per inserimento pistoni



	Ø mm	L mm	
1440/0	40÷75	50	1 014400000
1440/1	57÷125	80	1 014400010
1440/1A	57÷125	100	1 014400011
1440/2	90÷175	80	1 014400020
1440/2A	90÷175	100	1 014400021
1440/3	90÷175	165	1 014400030

1445/1 - 1445/2

attrezzi per segmenti di pistoni



	Ø mm	
1445/1	50÷100	1 014450001
1445/2	90÷150	1 014450002

1450GC

morsetto alzavalvole
con ganasce diritte e curve

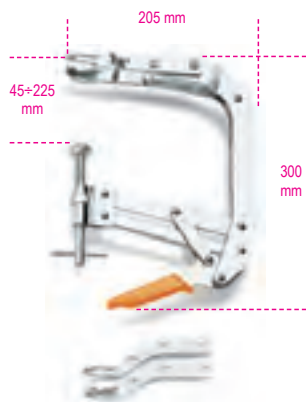

1450GC 1 014500005

1452K

morsetto alzavalvole
con tre flange

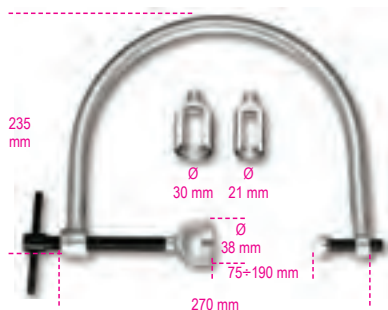

1452K 1 014520100

1452PN/K

attrezzo pneumatico per molle valvole motore

pressione di spinta 1400 N



Ø mm 16-19-23
L mm 230
L1 mm 185
1 014520110

1455SVP

smerigliavalvole pneumatico

• Pressione di utilizzo 6 Bar

CE



1455SVP 1 014550001

1455SVP/R...

ventose in gomma
di ricambio per 1455SVP



1455SVP/R1 5 014550501
1455SVP/R2 5 014550502
1455SVP/R3 5 014550503

1458

pinza per anelli elastici
di sicurezza SP per alberi



DIN 5417

Ø mm 30÷100
2 014580001

1460F

pinza per anelli di tenuta valvole



1460F 1 014600010

1461BF

blocchetti messa in fase motori
Fiat-Alfa Romeo-Lancia



1461BF/N 1 014610501
1461BF/AG 1 014610502
1461BF/R 1 014610503
1461BF/B 1 014610504
1461BF/O 1 014610505
1461BF/V 1 014610506
1461BF/GR 1 014610507
1461BF/S 1 014610508
1461BF/VI 1 014610509
1461BF/BR 1 014610510
1461BF/T 1 014610511
1461BF/A 1 014610512

1461/C3B

attrezzi per la messa in fase motori
Fiat/Alfa/Lancia benzina

Motori: 1.2-1.4 16V



1461/C3B 1 014610032

280x245x75 mm 1,5 kg

1461/C5G

attrezzi per la messa in fase motori Fiat/Alfa/
Lancia/Opel/Suzuki/Ford Diesel

Motori: 1.3 Multijet



1461/C5G 1 014610053

280x245x75 mm 2,6 kg

1461/C6B

attrezzi per la messa in fase motori
Peugeot/Citroën benzina

Motori: 1.0-1.1-1.4-1.6-1.6 16v-1.6Gti-1.6 18V-1.8-1.8 16v-1.9-
2.0-2.0 16v-2.0T-2.0 Hpi-2.2 16v



1461/C6B 1 014610063

310x290x120 mm 3,5 kg

1461/C6G

attrezzi per la messa in fase motori Peugeot/Citroën Diesel

Motori: 1.4-1.6-2.0D, 1.4-1.6TDCI, 1.4-1.6-2.0-2.2Hdi, 1.5-1.9-2.5D



1461/C6G

1 014610064

385x290x100 mm 3,8 kg

1461/C7B

attrezzi per la messa in fase motori Renault/Nissan benzina

Motori: 1.4-1.6-1.8-2.0 16V



1461/C7B

1 014610072

280x245x75 mm 3,2 kg

1461/C8B

attrezzi per la messa in fase motori Ford benzina

Motori: 1.25-1.4-1.6-1.6 SCTi-1.6 Ti-VCT-1.6 16V



1461/C8B

1 014610083

240x210x50 mm 1,8 kg

1461/C8G

attrezzi per la messa in fase motori Ford/Mazda Diesel

Motori: 1.4-1.6-1.8-2.0-2.2 TDCi, 1.6D 8/16V, 1.8D, 1.8D Turbo, 1.8 TCI, 1.8 TDDi, 2.5D, 2.5D Turbo



1461/C8G

1 014610084

280x245x75 mm 2,2 kg

1461/C9B

attrezzi messa in fase motori Opel benzina

Motori: 1.0 12V, 1.0-1.2-1.4 16V



1461/C9B

1 014610092

335x145x60 mm 2 kg

1461/C10A

attrezzi per messa in fase motori Audi, Seat, Skoda, Volkswagen Diesel

Motori: 1.9 - 2.0 TDI



1461/C10A

1 014610101

270x120x45 mm 1,1 kg

1461/C10G

attrezzi per la messa in fase motori Volkswagen/Audi/Seat e Skoda Diesel

Motori: 1.2-1.6-2.0 TDI CR (common rail)



1461/C10G

1 014610103

310x290x120 mm 2,8 kg

1461/C11A

attrezzi per messa in fase motori Renault Diesel

Motori: 2.0 dCi



1461/C11A

1 014610111

420x280x60 mm - 1,2 kg

1461/C11G

attrezzi per la messa in fase motori Renault Diesel

Motori: 1.5-1.9-2.2-2.5 dCi



1461/C11G

1 014610113

310x290x120 mm 3,8 kg

1461/C12A

attrezzi messa in fase
motori Fiat benzina e Diesel

Motori: 1.9-2.2 JTS e 1.9 JTD Euro 4



1461/C12A

1 014610123

280x245x75 mm - 1,8 kg

1461/C12G

attrezzi per la messa in fase motori
Fiat/Alfa/Lancia Diesel

Motori: 1.9 JTD, 1.6-1.9-2.0 Multijet



1461/C12G

1 014610124

280x245x75 mm - 2 kg

1461/C13A

attrezzi per messa in fase motori
Fiat benzina

motori: 0.9 Twinair turbo



1461/C13A

1 014610133

240x210x50 mm - 1,7 kg

1461/C13B

attrezzi per messa in fase motori
Fiat benzina

Motori: 1.4 Multiair



1461/C13B

1 014610134

240x210x50 mm - 2,8 kg

1461/C16

attrezzi per messa in fase
motori BMW Diesel
completo di estrattore pompa
Motori: 2.0-3.0 Diesel



1461/C16

1 014610160

335x145x60 mm - 4,3 kg

1461/C17

attrezzi per messa in fase
motori Volkswagen, Seat, Skoda benzina

Motori: 1.2 6-12V



1461/C17

1 014610170

142x102x40 mm - 1,5 kg

Beta

1461/C17B

attrezzi per la messa in fase motori
Volkswagen/Audi/Seat e Skoda benzina

Motori: 1.2 TSI



1461/C17B

1 014610171

1461/C18

attrezzi per messa in fase
motori Volkswagen, Audi, Skoda benzina

Motori: 1.4 - 1.6 FSI



1461/C18

1 014610180

335x145x60 mm - 1 kg

1461/C18B

attrezzi per la messa in fase motori
Volkswagen/Audi/Seat e Skoda benzina

Motori: 1.6-1.8-1.8T, 1.4-1.6-1.8-2.0 16V,
1.4-1.6-2.0 FSI



1461/C18B

1 014610182

310x290x120 mm - 2,5 kg

Beta

1461/C19

attrezzi per messa in fase motori Ford Diesel

Motori: 2.0-2.2-2.4 Duratorq



1461/C19

1 014610190

310x185x60 mm - 1,5 kg

1461/C20G

attrezzi per la messa in fase motori Fiat Iveco/Peugeot/Citroën/Ford Diesel

Motori: 2.2-2.3-3.0 Multijet



1461/C20G

1 014610221

385x290x100 mm 5,5 kg

1461/C21G

attrezzi per la messa in fase motore Renault Diesel

Motori: 1.6 dCi



1461/C21G

1 014610222

310x290x120 mm 3 kg

1461/C22B

attrezzi per la messa in fase motori Peugeot/Citroën benzina

Motori: 1.0-1.2 VTi



1461/C22B

1 014610223

280x245x75 mm 2 kg

1461/C23B

attrezzi per la messa in fase motori Opel benzina

Motori: 1.0 - 1.2 - 1.4 ecoflex



1461/C23B

1 014610224

280x245x75 2,5 kg

1461/C24B

attrezzi per la messa in fase motori Mini-Peugeot/Citroën benzina

Motori: 1.4 - 1.6 (N12-N14)



1461/C24B

1 014610225

280x245x75 mm 2,8 kg

1461/C25G

attrezzi per la messa in fase motori Mini Diesel

Motori: 1.6 diesel (W16D)



1461/C25G

1 014610226

270x120x45 mm 1 kg

1461/C26B

attrezzi per la messa in fase motori Fiat/Alfa Romeo/Lancia benzina

Motori: 1.2-1.4 8v



1461/C26B

1 014610227

280x245x75 mm 1,7 kg

1461/C27G

attrezzi per la messa in motori Bmw Diesel

Motori: 1.6-2.0D (N47-N47S)



1461/C27G

1 014610228

280x245x75 mm 2 kg

 **Beta**

1461/C28B

attrezzi per la messa in fase motori Volkswagen, Seat, Skoda benzina

motori: 1.0 - 1.0 Bluemotion Tech
1.0 Ecofuel/Ecomotive - 1.0 Green Tech



1461/C28B

280x245x75 mm - 1,7 kg



1 014610229

1461/C29B

attrezzi per la messa in fase motori Ford benzina

motori: 1.0 EcoBoost



1461/C29B

280x245x75 mm - 2,6 kg



1 014610209

1461/C30G

attrezzi per la messa in fase motori Volkswagen/Audi/Seat e Skoda Diesel

motori: 1.6-2.0 CR TDI
per motori a partire dall'anno 2012



1461/C30G

280x245x75 mm - 2 kg



1 014610231

1462/KD

assortimento utensili per estrazione iniettori Denso completo di massa battente



1462/KD

335x210x80 mm - 4,8 kg



1 014620060

1462/KI

assortimento utensili per estrazione iniettori Diesel Common Rail

Permette la rimozione degli iniettori DELPHI-BOSCH-SIEMENS-DENSO



1462/KI

530x470x140 mm - 20 kg



1 014620235

1462/KMRC

assortimento utensili per estrazione iniettori su motori Mercedes 2.1L, 2.2L, 3.0 V6 e Chrysler

Per iniettori Bosch (2.1 e 2.2L) e Delphi (3.0)
Si può procedere alla rimozione degli iniettori senza rimuovere il motore.
Particolarmente indicato per i modelli:
Mercedes Vito, Vario, CLK, Sprinter, Viano, Classe M, GL, C, GLK, E, CLS, S, R, G
Chrysler 300 C



1462/KMRC

310x300x118 mm - 3,5 kg



1 014620070

1462/KU

assortimento utensili universale per estrazione iniettori diesel common rail

completo di pinza e massa battente



1462/KU

390x290x100 mm - 4,5 kg



1 014620100

1462AD/BSC

adattatore per estrazione iniettori Bosch Common Rail

da utilizzare con articoli Beta 960KI e Beta 1462/KU



1462AD/BSC

1 014620435



1 014620435

1462AD/SMN

kit di adattatori per estrazione iniettori Siemens e Denso

da utilizzare con articolo Beta 960KI/1462KI



1462AD/SMN

1 014620436



1 014620436

1463/KIT

kit attrezzatura per blocco pulegge distribuzione



1463/KIT

280x140x75 mm - 1,2 kg



1 014630001

1464T

tester digitale per la misurazione di pressione e compressione

Con kit 960AD/TP2 e 1464IC permette di verificare:

- compressione motori benzina e diesel
- pressione olio motore
- bassa pressione common rail
- pressione iniezione benzina

Con kit 1464AP permette di verificare:

- pressione reale circuito common rail
- pressione pompa alta pressione

CARATTERISTICHE

- display touch screen da 5"
- batteria ai polimeri di litio ricaricabile
- completo di sensore da 80 bar (basse pressioni) e cavo USB



CE

1464T

1 014640050

1464AP

set per la verifica dell'impianto alta pressione dei motori diesel common rail, con 1464T.

Completo di:

- set tubi alta pressione
- raccordi di collegamento
- sensore da 2.000 bar



1464AP

1 014640450

1464IC

set completo di finti iniettori e finte candele per 1464T

Permette di collegarsi al motore per la verifica della compressione nei motori diesel con tester digitale 1464T.



Include:

- n° 22 false candele
- n° 5 falsi iniettori
- n° 1 kit falso iniettore universale per truck, motori marini e macchine agricole

1464IC

1 014640350

1467

strumento estrazione liquido freni



Pressione min 5 bar, Max 11,5 bar

1467

1,5

1 014670001

1467/RK1

kit tubo di ricambio per 1467



1467/RK1

1 014670501

1467/RK2

rabboccatore di ricambio per 1467



1467/RK2

1 014670502

1467LF

strumento elettrico per sostituzione liquido freni

dotato di "effetto pulsante"



"effetto pulsante"

- stop automatico con tanica vuota, che impedisce l'inserimento di aria
- volume massimo tanica: 20L
- pressione di esercizio: 0,4+3,5 bar
- alimentazione 230V

Dotazione inclusa:

- tanica di recupero olio dai freni
- 1 tappo universale + 1 tappo E20 standard

1467LF

1 014670100

1467LF/RC

contenitore con tubo di recupero per 1467LF



1467LF/RC

1 014670125

1468N

attrezzi per sostituzione piattelli valvole



1468N/1

1 014680011

1468N/2

1 014680012

1468N/3

1 014680013

1469C

svasatore tubi freno in cassetta



SAE J514
SAE J1065
DIN 74234

3/16" - 4,75 mm

350x300x105mm - 6 Kg

1 014690100

1469C-R

kit matrici e puntali per svasatura tubi freno

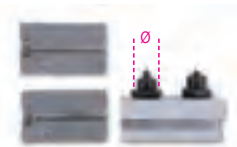

SAE J514
SAE J1065
DIN 74234

1469C-R 3/16

3/16"

1 014690501

1469C-R 4,75

4,75 mm

1 014690502

1469C-R 6

6 mm

1 014690503

1469C-R 8

8 mm

1 014690504

1469C-R 10

10 mm

1 014690505

1469C-R 12

12 mm

1 014690506

1470

pinze per molle freni a tamburo



L mm		
210	1	014700001
330	1	014700002
540	1	014700010

1470FT

pinza per fermi molle ceppi freni a tamburo

Becchi inclinati a 40°
Accesso facilitato nei punti scomodi



L mm		
184	1	014700000

1471

pinza per molle freni a tamburo



L mm		
330	1	014710001

1471A

pinza per cavo freno a mano



A max mm	B mm		
45	5	2	014710010

1471M/C22

utensile pneumatico per arretrare e ruotare i pistoncini dei freni a disco destrorsi e sinistrorsi con accessori

- martinetto automatico
- 150 Kg di spinta
- pressione di utilizzo 5+8 bar



1471M/C22	1	014710101

350x310x85 mm - 3,5 kg

1471M/50

martinetto pneumatico per arretrare e ruotare i pistoncini dei freni a disco destrorsi e sinistrorsi

- martinetto automatico
- 150 Kg di spinta
- pressione di utilizzo 5+8 bar

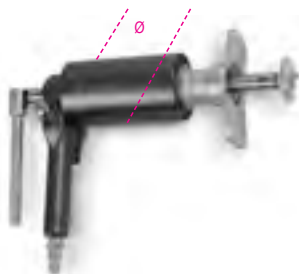

Ø mm	Kg	Bar		
50	150	5+8	1	014710069

1471M/P

adattatore per pastiglie usurate e pinze TRW-Mégane



1471M/P	1	014710080

1471M/W50

adattatore per freno stazionamento VW Passat ≥ 2005

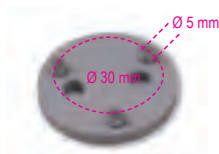

1471M/W50	1	014710079

1471PN/B1

adattatore per freno stazionamento Ford

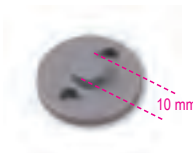

1471PN/B1	1	014710081

1471PN/B2

adattatore per freno stazionamento Daily



1471PN/B2	1	014710082

1471PN/B3

adattatore per freno stazionamento BMW

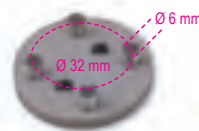

1471PN/B3	1	014710083

1471PN/B4

adattatore per freno stazionamento BMW

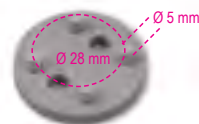

1471PN/B4	1	014710084

1471PN/B5

adattatore per freno stazionamento Mini/ BMW

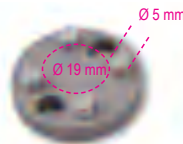

1471PN/B5	1	014710085

1471CF

chiavi a bussola a mano bocca pentagonale per dadi pinze freno



mm		
14	1	014710314
19	1	014710319

1471CM

chiave a bussola maschio pentagonale per viti pinze freno



mm		
10	1	014710360

1471CM/E11

chiave a bussola maschio esagonale 11 mm per viti pinze freno Mercedes ML (serie 166)



mm	Ø	L	L1		
11	24	75	15,5	1	014710361

1471D2

arreatore pistoncini freni a disco anteriori con pinze chiuse

doppia coppia di piastre per operare su pinze a 2 e 4 pistoncini



mm
10

250x170x60 mm 1,5 kg

1472

pinza per anelli stringitubo



1472 1 014720001

1472AU

pinza automatica per anelli stringitubo



mm
18+53

1472AU/P

pinza automatica con prolunga per anelli stringitubo



mm L
18+54 630

1472R/AU

puntali di ricambio per pinza 1472AU



1472 R/AU 1 014720101

1472AU/RP

cavo di ricambio per pinza 1472AU/P



1472 AU/RP 1 014720106

1472FC

pinza con teste orientabili, per fascette Clic®



1472FC 1 014720090

1472FC/L

pinza con prolunga flessibile a testa orientabile a 360°, per fascette Clic®



L
630 mm 1 014720095

1472FCL/RP

cavo di ricambio per pinza 1472FC/L



1472 FCL/RP 1 014720096

1472TM

pinza per scollegare i raccordi rapidi dei filtri multijet



1472TM 1 014720200

1472VW

pinza con teste orientabili per fascette stringitubo per vetture del gruppo Volkswagen e Mercedes



L
mm
200 1 014720051

1473

pinza per collari OETIKER®



1473 1 014730001

1473A

pinza con reggiasola per collari OETIKER®



1473A 1 014730010

1473Q

pinza con quadro di manovra, per collari OETIKER®

Utilizzabile con:
• chiavi dinamometriche
• cricchetti
• quadri maschi di manovra



1473 Q 1 014730005

1473P

pinza per collari OETIKER® pinzabili a basso profilo



A Max mm 53
1 014730020

1473FN

attrezzo per serraggio e taglio fascette a nastro in acciaio inox

utilizzabile con fascette Panduit® e similari



A mm 4,7÷9,5
1 014730501

1474/C4

kit 4 utensili estrazione bobine candele Volkswagen



1474/C4
290x190x50 mm - 1 kg

1474E/VW

estrattore ad espansione per bobine accensione gruppo Volkswagen



1474E/VW
1 014740120

1474L

pinza per cappucci candele d'accensione a becchi lunghi piegati 15°

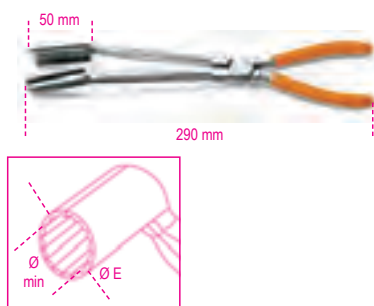

Ø min mm 14
Ø E mm 20
2 014740010

1474DL

pinza per cappucci candele d'accensione a becchi lunghi manici ricoperti con 2 strati in PVC

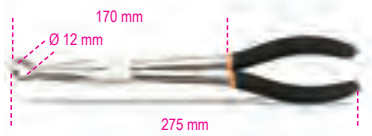

1474DL
1 014740015

1475U

pinza universale cromata lucida con impugnatura a "pistola" manici ricoperti con 2 strati in PVC



1475U
1 014750010

1476

pinza regolabile autobloccante per taglio tubi di scarico



Ø min mm 19
Ø max mm 75
1 014760001

1476/RC

catena di ricambio per 1476



1476/RC
1 014760010

1476A

pinza per taglio tubi di scarico

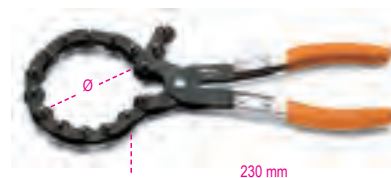

Ø min mm 30
Ø max mm 95
1 014760005

1476A/RC

catena di ricambio per 1476A



1476A/RC
1 014760015

1476C/1

attrezzi espansori per tubi di scarico



1476C/1
Ø 30÷42 mm
L = 131 mm
L1 = 51 mm
1 014760101

1476GT

pinza per rimozione supporti in gomma per tubi di scarico



L mm 280
A Max mm 58
S mm 3
1 014760050

1476PSA

pinza per fascette di scarico con perno, gruppo PSA

la forma dei becchi e il blocco automatico della cremagliera permettono di operare senza sfilare il perno



L mm 309
A Max mm 60
S mm 12,2
1 014760060

1476T

chiave per smontaggio/montaggio turbine su motori diesel, gruppo Volkswagen Audi



mm 12 1 014760200

1477/C10

chiave curva con 9 inserti per dadi tendicinghia

1 chiave curva con attacco per inserti
4 inserti poligonali doppi: 12x14 - 13x15 - 16x17 - 18x19 mm
5 inserti per viti con profilo Torx: E10 - E12 - E14 - E16 - E18



1477/C10 1 014770310
530x110x55 mm

1477D

chiavi poligonali per dadi tendicinghia



mm 13 1 014770113
15 1 014770115
16 1 014770116
17 1 014770117
19 1 014770119

1477D/S5

serie di 5 chiavi poligonali per dadi tendicinghia



1477D/S5 1 014770200
13-15-16-17-19 mm
600x200x70 mm - 2,2 kg

1477K/7

kit chiave curva a cricchetto reversibile con inserti



- 2 Inserti Torx® T40-T45
- 1 Inserto XZN® 10
- 1 Inserto esagonale 8 mm
- 3 Inserti poligonali 10-12-13 mm
L mm 250 1 014770051

1478

pinza per estrazione pioli



1478 1 014780001

1478T

pinza con testa orientabile per pioli in plastica con clips a pressione testa orientabile a 90°

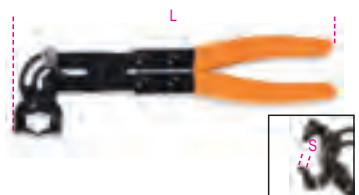

L mm 240 S mm 4,5 1 014780101

1479

estrattore per pioli



1479 2 014790001

1479/B27

kit di 27 attrezzi in nylon per pioli e interventi su plastiche e guarnizioni in busta appendibile



1479/B27 1 014790407

1479RB/1

raschietto a battere tipo diritto



1479RB/1 1 014790315

1479RB/2

raschietto a battere tipo piegato



1479RB/2 1 014790320

1479RB/3

raschietto a battere tipo piatto



1479RB/3 1 014790310

1479U/13

levapioli lama inox



1479U/13 2 014790010



1479U/32

levapioli lama inox



1479U/32

2 014790015

1479N/S5

kit di 5 levapioli in nylon



1479N/S5

1 014790251

1480

kit riempimento filtri gasolio per auto senza pompa elettrica

• Utilizzabile anche con pistola gonfiagomme

Il kit include:

- attacchi rapidi GM
- attacchi rapidi Renault, GM, Fiat Ø interno 6 mm
- attacchi rapidi Renault, GM, Fiat Ø interno 7 mm
- attacchi rapidi Ford
- attacchi rapidi PSA Ø interno 6 mm
- attacchi rapidi PSA Ø interno 7 mm
- attacchi rapidi Ford
- 2 adattatori conici per vetture senza attacchi rapidi



1480

1 014800010

410x320x70 mm

1481/C12

kit 6 coppie pinze per occlusione tubazioni

- 2 coppie differenti pinze misura 1/4"
- 2 coppie differenti pinze misura 3/8"
- 2 coppie differenti pinze misura 5/16"
- 3 coppie tappi in gomma



1481 /C12

1 014810312

370x270x59 mm

1481PL/A

pinza in plastica per occlusione tubi e manicotti

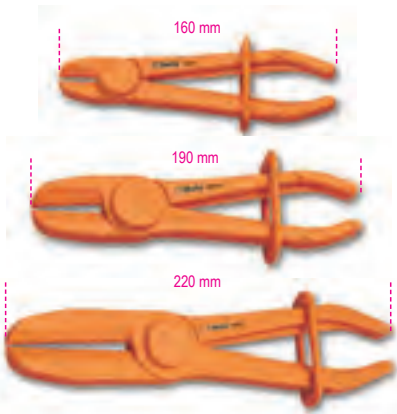

	Ø mm	
1481PL/A	8÷15	3 014810110
1481PL/B	15÷25	3 014810120
1481PL/C	25÷45	3 014810130

1481PL/S3

serie di 3 pinze in plastica per occlusione tubi e manicotti

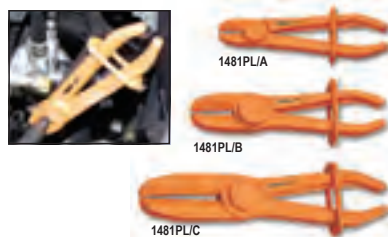

	Ø mm	
1481PL/S3		1 014810200
1481PL-A	Ø 8÷15 mm	
1481PL-B	Ø 15÷25 mm	
1481PL-C	Ø 25÷45 mm	

1482

chiave regolabile autoserrante per ghiera galleggianti serbatoio



Ø mm
89÷170

1 014820001

1482A/1

chiave a 3 zampe per ghiera galleggianti serbatoio con ghiera in alluminio per agire sulla ghiera in alluminio montata dal 2011 su vetture dei gruppi Fiat, Volkswagen, Opel, Chevrolet, Mercedes e BMW



12°

Ø mm
185

1 014820005

1482A/2

chiave per ghiera galleggianti serbatoio a 12 settori per agire sulla ghiera senza intagli laterali montata su vetture e furgoni del gruppo Fiat e Ford



12°

Ø mm
132

1 014820006

1482A/3

chiave per ghiera galleggianti serbatoio gruppo PSA il disegno permette di operare sull'asse decentrato rimuovendo la ghiera, senza danneggiare il delicato pescante



Ø mm
157

1 014820007

1482/8 - 1482/10

pinze per raccordi rapidi
tubi carburante

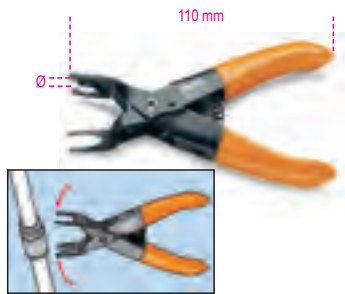

	Ø mm		
1482/8	8	2	014820008
1482/10	10	2	014820010

1482B

pinza per raccordi rapidi
tubi carburante



1482B	1	014820021
-------	---	-----------

1482C

2 coppie di cunei per sgancio raccordi filtri
gasolio gruppo Fiat, Volkswagen, Jeep,
Chrysler e Volvo

rapida sostituzione del filtro senza danneggiare
irrimediabilmente i raccordi



1482C	1	014820022
-------	---	-----------

1483K/12

kit per smontaggio valvole
impianto aria condizionata
con serie di inserti pentalobati

- Il kit include:
- 2 bussole femmina ottagonali Ø 12 e 15 mm per valvole alta pressione
 - 2 bussole maschio a forchetta sezione 2,2 e 3,2 mm per valvole a farfalla
 - 1 serie di inserti pentalobati misura: PT10, PT15, PT20, PT25, PT27, PT30, PT40

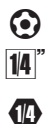

1483 K/12	1	014830012
-----------	---	-----------

120x80x35 mm

1483KV-PT/S7

serie di inserti pentalobati

misure incluse:
PT10 - PT15 - PT20 - PT25 - PT27 - PT30 - PT40



1483KV-PT/S7	1	014830117
--------------	---	-----------

1483K/22

kit per la separazione di raccordi su impianti di
condizionamento, alimentazione e
lubrificazione



1483K/22	1	014830022
----------	---	-----------

300x230x55 mm - 1 kg

1484

set di 2 utensili per la rimozione e il montaggio
delle cinghie elastiche

Permette una rapida rimozione
e un corretto montaggio della cinghia elastica
senza rischio di danneggiamento



1484	1	014840010
------	---	-----------

1485/KIT

kit attrezzi per controllo tensione
cinghia distribuzione



1485/KIT	1	014850100
----------	---	-----------

230x140x75 mm - 580 g

1485R

attrezzo per rotazione pulegge distribuzione
in acciaio forgiato
con 2 coppie di puntali



Ø mm	Ø1 mm	L mm	
30-120	10-17	500	1 014850025

1485R/P10

coppie di puntali

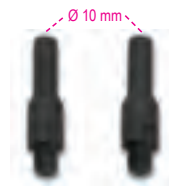

1485R/P10	1	014850035
-----------	---	-----------

1485R/P17

coppie di puntali



1485R/P17	1	014850038
-----------	---	-----------

1486/10

chiave per valvole bombole metano

- gruppo VW dal 2008
- Panda dal 2004 al 2012
- Grande Punto dal 2005 al 2012
- Ducato dal 2010
- nuovi Doblò e Combo
- Cubo e Fiorino

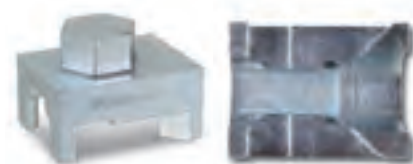

36 mm

1486/10	1	014860110
---------	---	-----------

Beta

1486/20

chiave per valvole bombole metano

- Multipla
- Ducato 1ª e 2ª serie fino al 2010
- Berlingo e Ranch
- C3 con bombole in ferro
- Punto dal 1999 al 2010
- Doblò 1ª serie
- Daily e gruppo Iveco
- Dr5

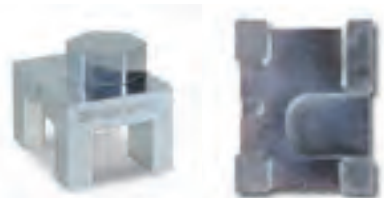

36 mm

1486/20



1 014860120

1486/30

chiave per valvole bombole metano

- Zafira 2ª serie
- Combo 1ª serie

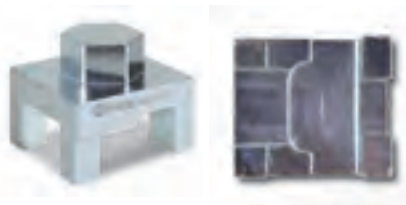

36 mm

1486/30



1 014860130

1486/40

chiave per valvole bombole metano

- Touran 1ª serie



36 mm

1486/40



1 014860140

1486/50

chiave per valvole bombole metano

- Panda dal 2012
- Nuova Ypsilon



36 mm

1486/50



1 014860150

1486/60

chiave per valvole bombole metano

- C4 Picasso
- impianti BRC

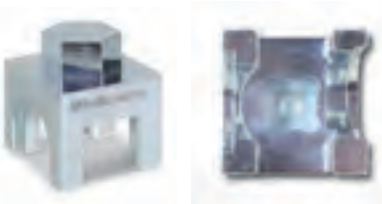

36 mm

1486/60



1 014860160

1486/70

coppia di chiavi per valvole bombole metano

- C3 con bombole in composito



36 mm

1486/70



1 014860170

1486/80

chiave per valvole bombole metano

- Classe B
- Zafira 3ª serie



36 mm

1486/80



1 014860180

1486/90

chiave per valvole bombole metano

- Zafira 1ª serie
- Kangoo 1ª serie
- Sprinter



36 mm

1486/90



1 014860190

1488 - 1488L

chiave snodata a catena doppia per filtri olio



	Ø mm		
1488	60÷110	1	014880001
1488L	60÷160	1	014880050

1488/1

chiave a catena doppia sottile per filtri olio



	Ø mm		
1488/1	60÷110	1	014880010

1488R...

catena di ricambio



1488RC	1488	1	014880101
1488R/L	1488/L	1	014880150
1488RC/1	1488/1	1	014880110

1489/31T

chiave per ruota libera puleggia alternatore



	15	31	
T50			1 014890016

1489/33

chiave per ruota libera puleggia alternatore Bosch



	33		
1489/33		3	014890010

1489/33P

chiave per ruota libera puleggia nuovo alternatore Bosch FIAT Grande Punto



	M	15	31	
1489/33P				1 014890015

1489/E

chiave per ruota libera
puleggia alternatore



mm	mm		
10	15	1	014890025

1489R

chiave per ruota libera
puleggia alternatore Renault



1489R	1	014890020
-------	---	-----------

1489/Y

chiave per ruota libera
puleggia alternatori Nippondenso



mm			
32		3	014890040

1489/C14

assortimento di 14 utensili per le pulegge
libere degli alternatori



1489/C14	1	014890100
----------	---	-----------

	867PE	8 mm
	867PE/L	8 mm
	867XZN/L	M10
	867TX/L	T50
	867/2	□1/2"
	920B	10 mm
	1489/33	
	1489/33P	M10
	1489R	
	1489/Y	
	1489/31T	T50
	1489/E	10 mm
	188	10 mm
	188	15 mm

420x250x45 mm - 1,9 kg

1490

chiavi a nastro per filtri olio

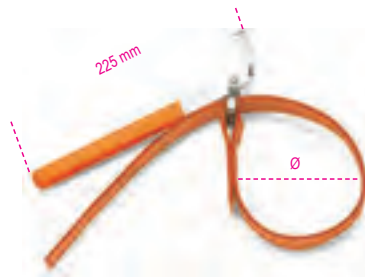

	Ø max mm		
1490/1	160	1	014900001
1490/2	240	1	014900002

1490/R1 - 1490/R2

nastri in tessuto di ricambio per 1490



	Ø mm		
1490 /R1	160	1	014900101
1490 /R2	240	1	014900102

1491

chiave a nastro metallico regolabile
per filtri olio



	Ø mm		
1491	65÷110	2	014910001

1491R

nastro metallico di ricambio per 1491



1491R	10	014910010
-------	----	-----------

1491C

pinza regolabile per filtri olio



	Ø mm	L mm		
1491C	60÷100	300	1	014910030

1492/1 - 1492/2

chiavi regolabili per filtri olio

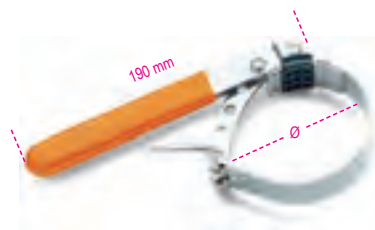

	Ø mm		
1492/1	60÷80	1	014920001
1492/2	80÷110	1	014920002

1492T

chiavi per filtri essiccatori



	Ø mm	H mm		
1492/T40	125÷145	40	1	014920540
1492/T75	120÷140	75	1	014920575

1493

chiave a bussola per filtri olio

N=numero lati



	Ø mm	N		
1493	65	14	1	014930200
	68	14	1	014930206
	73	14	1	014930208
	74	14	1	014930209
	74	15	1	014930210
	75-77	15	1	014930212
	76	8	1	014930214
	76	14	1	014930218
	76-74	15	1	014930220
	78	15	1	014930224
	80	15	1	014930226
	82-80	15	1	014930228
	86	16	1	014930230
	90	15	1	014930234
	92	10	1	014930236
	93	15	1	014930238
	95	15	1	014930244
	100	15	1	014930248
	106	15	1	014930250
	108	15	1	014930252
	135	18	1	014930256

1493/PF

chiavi a bussola per filtri olio
Purflux
N=numero lati

12"



Ø mm	N		
66	6	1	014930202
76	12	1	014930216
76	30	1	014930222
86	18	1	014930232
93	36	1	014930240
93	45	1	014930242
96	9	1	014930070
96	18	1	014930246
108	18	1	014930254

1493/C30

serie di 28 chiavi a bussola
per filtri olio

12"



Misure incluse nel kit (Ø mm / n° lati)
1493:

65/14 - 67/14 - 68/14 - 73/14 - 74/15
76/15 - 75.77/15 - 76/14 - 76/8 - 78/15 - 80/15
82/15 - 86/16 - 90/15 - 92/10 - 93/15 - 95/15
100/15 - 106/15 - 108/15

1493PF (Purflux)

66/6 - 76/12 - 76/30 - 86/18
93/36 - 93/45 - 96/18 - 108/18

- inclusa 1 chiave regolabile universale
Ø 65±120 mm

1493/C30 1 014930000

530x400x110 mm - 4 kg

1493AL

chiavi a bussola per filtri olio

N= numero lati

38"

12"



Ø mm	N		
64	14	27	1 014930310
66,5	14	27	1 014930315
74	14	27	1 014930320
79	15	27	1 014930325
84	14	27	1 014930330
87	16	27	1 014930335
92	15	27	1 014930340
94,5	15	27	1 014930345
100,5	15	27	1 014930350

1493AL 4S

chiavi a bussola per filtri olio
per auto asiatiche
profilo a 4 settori

38"

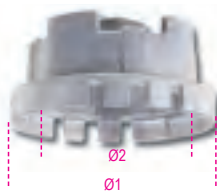

Ø1 mm	Ø2 mm		
70	64,5	27	1 014930304
80	64,5	27	1 014930305

1493AL CF

chiavi a bussola esagonale
per cartucce filtri olio

12"



Ø mm	H mm		
24	34	27	1 014930424
27	34	27	1 014930427
30	34	27	1 014930430
32,5	34	27	1 014930432
36	34	27	1 014930436
38	34	27	1 014930438

1493/C19

serie di 18 chiavi a bussola per filtri olio.
particolarmente indicate per auto asiatiche

Misure incluse nella serie:

Ø mm N lati

63-64 14

66,5 14

74 14

79 15

84 14

87 16

92 15

94,5 15

100,5 15

70 14 a settori per Toyota

80 14 a settori per Lexus

N° 6 bussole esagonali misura 24-27-30-32,5-36-38 mm per
cartucce filtro

Il kit include 1 chiave regolabile universale Ø 58±93 mm

12"

38"



1493 /C19 1 014930019

490x450x60 mm - 4 kg

1493FF

chiave per smontaggio/montaggio della sede
in plastica di filtri olio Ford Peugeot Citroën
motori: TDCi-HDi

permette di serrare correttamente la sede in plastica
con chiave dinamometrica a 25 Nm.

12"

12"



27

1 014930127

1493/S-U

chiave autoregolabile a tre bracci
per filtri olio destrorsa-sinistrorsa

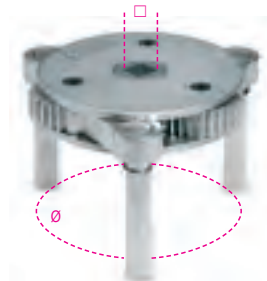

	Ø mm		
1493/S	3/8-1/2	80-115	1 014930074
1493/U	1/2	105-165	1 014930076

1493T

chiave autoregolabile a tre bracci
per filtri olio sinistrorsa



Ø mm
60±120

1 014930075

1493J

chiave per filtri gasolio Multijet

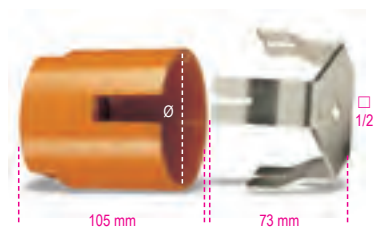

Ø mm
90

1 014930080

1493Z/1 - 2 - 3

chiavi autoserranti per filtri olio sinistrorse

12"



	Ø mm		
1493Z/1	60÷80	1	014930090
1493Z/2	80÷100	1	014930095
1493Z/3	100÷125	1	014930100

1494

chiave a bussola quadrata per tappi olio motore

12"



mm		
10	1	014940280

1494E

chiavi a bussola maschio esagonale per tappi olio motore

12"



mm		
8	1	014940208
9	1	014940209
10	1	014940210
11	1	014940211
12	1	014940212
14	1	014940214
17	1	014940217

1494Q

chiavi a bussola maschio quadrato per tappi olio motore

12"



mm		
8	1	014940258
9,5	1	014940259
12	1	014940262
13	1	014940263

1494T

chiave a bussola maschio triangolare per tappi olio motore

12"



mm		
9,5	1	014940289

1494XZN

chiave a bussola maschio con profilo XZN® per tappi olio motore

12"



M		
16	1	014940296

1494VW

chiave speciale per tappi olio in plastica motori gruppo Volkswagen

permette di rimuovere e installare il tappo in plastica dalla coppa dell'olio. Specifico per vetture del gruppo Volkswagen con motori TFSI e TDI



M		
16	1	014940305

1494/C14A

assortimento di 14 utensili per cambio olio

12"



M		
16	1	014940150

- 1494E 8-9-10-11-12-14-17
- 1494Q 8-9,5(3/8")-12-13
- 1494 10
- △ 1494T 9,5(3/8")
- 1494XZN M16

380x305x40 mm - 1,7 kg

1494M

attrezzo per tappi olio esagonali magnetico e flessibile

permette di svitare il tappo senza rischi di scottature e senza sporcarsi

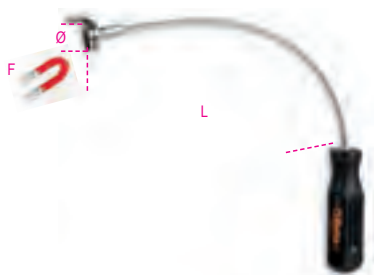

L mm	F kg	Ø mm	
293	2,5	19	1 014940401

1495/C6

assortimento di utensili per la riparazione dei filetti della coppa olio



• Il filetto danneggiato viene rimosso con il maschio filettato e allargato di una misura

• Consente la riparazione ed evita la sostituzione della coppa olio

Composto da:

- 1 maschio M13x1,25 + 6 viti + 12 rondelle
- 1 maschio M13x1,5 + 6 viti + 12 rondelle
- 1 maschio M15x1,5 + 6 viti + 12 rondelle
- 1 maschio M17x1,5 + 6 viti + 12 rondelle
- 1 maschio M20x1,5 + 6 viti + 12 rondelle
- 1 maschio M22x1,5 + 6 viti + 12 rondelle

M		
16	1	014950500

420x185x60 mm - 2,1 kg

1495M

maschio per filetti tappi olio



M		
13x1,25	1	014950553
13x1,50	1	014950563
15x1,50	1	014950565
17x1,50	1	014950567
20x1,50	1	014950570
22x1,50	1	014950572

1495T

kit di 6 tappi olio e rondelle



M		
13x1,25	1	014950503
13x1,50	1	014950513
15x1,50	1	014950515
17x1,50	1	014950517
20x1,50	1	014950520
22x1,50	1	014950522

1496/A

chiavi per tappi olio motore



□ 10 x	■ 10 mm	
		2 014960001

1496/C

chiavi per tappi olio motore



■ 8 x ■ 10 mm

3 014960010

1497D

pinza con becchi dritti per estrazione relé



A
min+Max
mm
1497 D 15÷50

1 014970150

1497P

pinza con becchi piegati a 60° per estrazione relé



A
min+Max
mm
1497 P 15÷50

1 014970160

1497/C23

assortimento di 23 utensili per sblocco connettori elettrici



1497/C23

1 014970200

■ 440x250x70 mm - ■ 1,7 kg

1497/C94

assortimento di 94 connettori per test su autovetture utilizzabili con i principali strumenti di diagnosi

- 2 rubacorrente
- 2 potenziometri
- 2 spie di segnalazione
- 2 connettori SRS
- 2 coccodrilli
- 2 sonde ad ago
- 2 puntali
- 2 connettori a banana doppi
- 4 connettori a banana singoli
- 24 terminali maschio piatti 0.6÷6 mm
- 12 terminali maschio tondi 1.6÷3.9 mm
- 24 terminali femmina piatti 0.6÷6 mm
- 12 terminali femmina tondi 1.6÷3.9 mm



1497/C94

1 014970300

■ 430x390x100 mm - ■ 3 kg

1497RC

coppia di rubacorrente

- sezione cavi: 1,5÷3,5 mm
- voltaggio: 0÷330V
- corrente massima 5A



1497RC

1 014970351

1498

provatensione

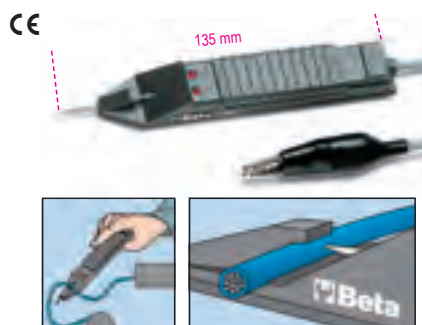

3÷48V

2 014980100

1498MN/12

avviatore portatile multifunzione

- Avviamento di veicoli con batteria 12 Volt (diesel e benzina fino a 2000 cc.)
- Ricarica di tablet, telefoni cellulari e apparecchi elettronici in genere
- Torcia LED multifunzione



CE



DOTAZIONE

- batteria con tecnologia Lito-Cobalto
- cavi di avviamento con pinze isolate e dispositivo di protezione contro inversione di polarità e corto circuito
- uscita USB per caricare dispositivi elettronici
- display digitale e indicatore di carica della batteria
- cavo USB con adattatori di ricarica
- alimentatore da rete e da auto

DATI TECNICI

Corrente di spunto: 600A
Tipo di batteria: LiCoO2
Uscita per avviamento: 12 Volt

1498MN/12

1 014980000

1498MN/12-C

cavo di avviamento con pinze per 1498MN/12



1498MN/12-C

1 014980005

1498/12

avviatore per auto 12V portatile



CE

DATI TECNICI:

- Corrente di spunto 2200A
- Tracolla per trasporto inclusa
- Batteria ermetica al piombo electrolyte solido (AGM)

1498/12

1 014980480

■ 13 kg

1498/24

avviatore per auto e veicoli commerciali
12-24V portatile



DATI TECNICI:

- Corrente di spunto 4200A (12V) - 2100A (24V)
- Tracolla per trasporto inclusa
- Batteria ermetica al piombo electrolyte solido (AGM)

1498/24 1 014980490

17 kg

1498B12/R02

batteria di ricambio 12V
per avviatori 12-24V



1498B12/R02 1 014980502

1498C/24

avviatore carrellato 24V



- struttura carrellata per facilitare gli spostamenti e ridurre al minimo gli sforzi
- prestazioni molto elevate per numerosi avviamenti anche particolarmente impegnativi
- caricabatterie elettronico in dotazione
- segnalazioni led e acustiche in caso di inversione di polarità
- sistema di protezione contro i picchi di tensione
- indicazione del livello di carica della batteria
- batteria ermetica al piombo electrolyte solido (AGM)

Amperaggio continuo	1700 A
Tensione utilizzo	24 V
Amperaggio di spunto	4000 A
Lunghezza cavi	2000 mm
Sezione cavi	70 mm ²
Tensione di ricarica	230 V
Caricabatterie automatico	24 V - 10 A

1498C/24 1 014980244

1498/4A

caricabatterie elettronico 6-12V auto-moto



- protezione di inversione polarità, corto circuito
- selezione automatica della tensione 6 o 12 Volt
- selezione automatica del tipo di batteria
- display digitale retroilluminato
- gancio di fissaggio reclinabile

DATI TECNICI

Tensione di alimentazione: 220V-240V
 Frequenza: 50-60 Hz
 Corrente nominale (min-max): 1-4 Amp
 Tensione della batteria: 6V/12V
 Capacità batteria: 4Ah-80Ah
 Tempo di ricarica: 12 ore
 Grado di protezione: IP65

1498/4A 1 014980104

1498/8A

caricabatterie elettronico 12V auto-veicoli
commerciali



- carica lenta e veloce (2A-8A)
- funzione recupero batterie scariche
- funzione alimentatore 13,8V-5A
- protezione di inversione polarità e corto circuito
- selezione manuale tipo batteria
- display digitale retroilluminato
- gancio di fissaggio reclinabile

DATI TECNICI

Tensione di alimentazione: 220V - 240V
 Frequenza: 50-60 Hz
 Corrente nominale (min-max): 2-8 Amp
 Tensione della batteria: 12V
 Capacità batteria: 5Ah-160Ah
 Funzione Memory Saver: 13,8V - 5A
 Grado di protezione: IP65

1498/8A 1 014980108

1498/40A

caricabatterie avviatore multifunzione 12-24V
carrellato



- 3 cicli di carica programmati e 1 ciclo manuale
- potenziometro di regolazione elettronica
- processi specifici di carica WET-SPIRAL/GEL-AGM
- sistema di controllo e protezione elettronico
- processo di carica a 10 fasi
- funzione desolfatazione e recupero batteria
- funzione supply
- doppia tensione 12-24V
- idoneo anche per batterie Start&Stop
- pinze professionali in ottone isolate in gomma

DATI TECNICI

Alimentazione: 230V
 Tensione in uscita: 12-24V
 Corrente di carica: 1-40A
 Corrente di avviamento: 350A max cc
 Capacità di ricarica: 4-450Ah

1498/40A 1 014980140

330x250x792

1498/50A

caricabatterie elettronico 12V multifunzione

Per la carica e l'alimentazione dei veicoli
durante tutte le fasi di riprogrammazione e autodiagnosi



CARATTERISTICHE

- corrente max di carica/alimentazione 50 Ampere
- carica
- funzione recupero batterie scariche
- alimentazione per protocolli diagnosi ECU
- gestione elettronica con microprocessore
- protezione contro inversione polarità e corto circuito

DATI TECNICI

Lunghezza cavi: 3m
 Sezione: 10 mm²
 Capacità di carica: 5+500Ah
 Capacità mantenimento: 5+1500Ah
 Tensione: 12V

1498/50A 1 014980050

150x100x250 mm

1498SM

salva memorie 12 V

evita la perdita dei dati memorizzati dal computer di bordo delle autovetture durante le operazioni di manutenzione o sostituzione della batteria.



DATI TECNICI:

- autoalimentato
- batteria interna Pb 5 Ah
- 12 Volt
- connessione professionale con presa OBD

1498SM 1 014980020

1498TB/12

tester digitale per batteria 12V

- permette di effettuare i seguenti test: batteria, alternatore e avviamento
- dotato di software per stampare il test eseguito da PC
- display retroilluminato
- struttura compatta e antiurto
- software in 10 lingue
- dotato di un apposito ingresso per il collegamento di una mini stampante estraibile (accessorio opzionale)



DATI TECNICI:

- **applicazioni:** Test batterie 12V - Test alternatore 12V carica - Test sistemi avviamento
- **intervallo di funzionamento:** 100-1700 CCA
- **normative di riferimento:** CCA, SAE, DIN, EN, IEC, JIS
- **batterie supportate:** PB, Wet, Gel, Agm, Mf, Vrla, Sli
- **voltmetro:** 9V-15V
- **lunghezza cavi:** 180 cm
- **lingue:** Italiano, Inglese, Francese, Tedesco, Spagnolo, Polacco, Rumeno, Olandese, Svedese e Finlandese
- **accessori inclusi:** Cavo USB e Software

1498TB/12 1 014980400

320x270x100 mm

1498ST/TB

mini stampante termica per Tester 1498TB/12

- possibilità di collegare la mini stampante direttamente sul tester
- permette di stampare i risultati del test effettuato



1498ST/TB 1 014980410

1498TC

tester digitale per candele di preriscaldamento

- Permette un rapido e preciso test delle candele di preriscaldamento
- adatto a tutti i tipi di candele 4,4-5-7-8,5-10-11 Volt
- display digitale retroilluminato
- adatto alle candele in acciaio e in ceramica
- protetto contro il cortocircuito e inversione di polarità
- spegnimento automatico quando inutilizzato

- dotato di segnalatore acustico
- dotato di torcia a led SMD
- struttura compatta ed antiurto



DATI TECNICI:

- **range di misura:** 0.00±25.0Ω
- **tolleranza:** ± 2%
- **risoluzione:** 0.01
- **led Display:** 1.8"
- **temperatura di esercizio:** 0°C+50°C
- **alimentazione:** 1 batteria 9V (non inclusa)

1498TC 1 014980450

1499

stetoscopio



1499 1 014990001

1500/...

estrattori universali a due gire

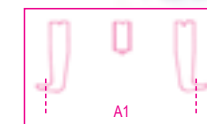

	L mm	
1500/1	100	1 015000301
1500/2	100	1 015000302
1500/3	150	1 015000303
1500/4	150	1 015000304
1500/5	205	1 015000305
1500/6	205	1 015000306
1500/7	205	1 015000307
1500/8	230	1 015000308

	A min+Max mm	A1 min+Max mm
1500/1	25÷80	70÷130
1500/2	25÷130	80÷180
1500/3	50÷160	105÷220
1500/4	60÷200	120÷270
1500/5	80÷250	160÷330
1500/6	80÷350	160÷420
1500/7	110÷520	195÷600
1500/8	170÷640	260÷715

1500/SP5 1 015000325

1500/1-1500/2-1500/3

1500/4-1500/5

1500/SPV 1 015000001

1500G/...

coppia di griffe tipo normale per 1500 e 1580/81



	mm	griffe	1500		
1500G/1	35	/1-2	1	015000311	
1500G/3	35	/3-4	1	015000313	
1500G/5	35	/5-6-7	1	015000315	
1500G/8	50	/8	1	015000317	
		1580/81			

1500N/...

estrattori universali a 2 griffe scorrevoli

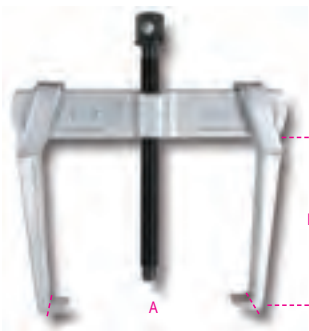

	A min+Max mm	L mm		
1500N/0	18÷65	70	1	015000600
1500N/1	23÷70	100	1	015000601
1500N/2	23÷100	100	1	015000602
1500N/3	35÷140	150	1	015000603
1500N/4	35÷190	150	1	015000604
1500N/5	43÷250	205	1	015000605
1500N/6	43÷320	205	1	015000606



1500N/SP6	1	015000626
1500N/0-1500N/1-1500N/2-1500N/3		
1500N/4-1500N/5		
1500N/SPV	1	015000006

1500N/G...

griffe per estrattori 1500N



	mm	griffe	1500N		
1500N/G0	10	/0	2	015000650	
1500N/G1-2	12	/1-2	2	015000651	
1500N/G3-4	17	/3-4	2	015000653	
1500N/G5-6	23	/5-6	2	015000655	

1501/1 - 2 - 3

estrattori a griffe sottili



	L mm		
1501/1	100	1	015010101
1501/2	200	1	015010102
1501/3	250	1	015010103

	A min+Max mm
1501/1	25÷130
1501/2	25÷130
1501/3	25÷130

1501G/1 - 2 - 3

coppie di griffe per 1501



	L mm		
1501G/1	100	1	015010111
1501G/2	200	1	015010112
1501G/3	250	1	015010113

1501Z/S - P - R

terminali per griffe 1501G



	mm	D mm		
1501Z/S	2,0	27	2	015010211
1501Z/P	3,6	27	2	015010212
1501Z/R	3,6	14	2	015010213

1505V

estrattore per bracci tergilicristalli e tergilunotti

puntale in ottone forato removibile per estrazione bracci con ugello lavavetro integrato



	A Max mm	L mm		
1505V	43	37	1	015050001

1505/C5

kit per estrazione tergilicristalli

1 estrattore a 2 griffe Ø 25÷40 mm
4 mezzalune Ø 25 mm, Ø 30 mm, Ø 35 mm, Ø 41 mm



	mm		
12		1	015050300

320x150x60 mm - 1,2 kg

1506

estrattore autoserrante a due griffe

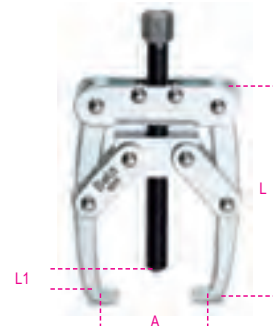

	A min+Max mm	L mm	L1 mm		
1506	10÷50	80	40	1	015060001

1508/1 - 1508/2

estrattori a due griffe
tipo leggero



	L mm		
1508/1	105	1	015080001
1508/2	130	1	015080002

	A min=Max mm	L1 mm
1508/1	6÷100	105
1508/2	10÷140	130

1511/1 - 2 - 3

estrattori a due griffe reversibili
per esterni

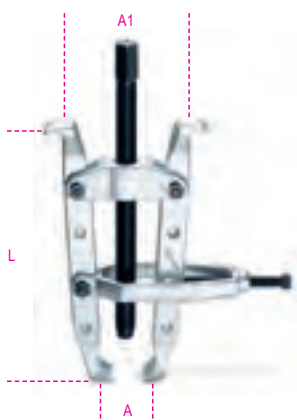

	L mm		
1511/1	235	1	015110001
1511/2	350	1	015110002
1511/3	405	1	015110003

	A min=Max mm	A1 min=Max mm
1511/1	20÷100	65÷95
1511/2	40÷150	103÷190
1511/3	40÷150	103÷175

1515/1 - 2 - 3

estrattori a due griffe
oscillanti

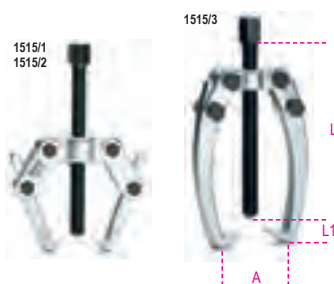

	L mm		
1515/1	85	1	015150101
1515/2	85	1	015150102
1515/3	105	1	015150103

	A Max mm	L1 mm
1515/1	60	105
1515/2	70	105
1515/3	90	105

1516/1 - 2 - 3

estrattori a tre griffe
oscillanti



	L mm		
1516/1	85	1	015160001
1516/2	85	1	015160002
1516/3	105	1	015160003

	A Max mm	L1 mm
1516/1	60	85
1516/2	70	85
1516/3	90	105

1517

estrattori 3 griffe autoserranti

- per elevati carichi d'estrazione.
- effetto autoserrante.



	L mm	L1 mm	O mm		
1517/90	182	60	22	1	015170000
1517/150	242	115	22	1	015170010
1517/200	307	150	22	1	015170020
1517/260	395	180	30	1	015170030

	● mm	A mm	kg	N
1517/90	19	18÷90	6000	59000
1517/150	19	25÷150	6000	59000
1517/200	19	40÷200	6000	59000
1517/260	27	50÷260	8000	78500

1518/...

estrattori a tre griffe



	L mm		
1518/1	105	1	015180001
1518/2	135	1	015180002
1518/3	235	1	015180003
1518/4	270	1	015180004
1518/5	270	1	015180005
1518/6	270	1	015180006

	A min=Max mm	L1 mm
1518/1	24÷100	105
1518/2	32÷160	150
1518/3	40÷220	220
1518/4	80÷250	240
1518/5	80÷300	350
1518/6	80÷350	400

1520/1 - 1520/2

estrattori a due griffe reversibili

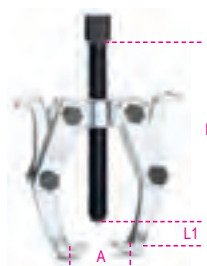

	L mm		
1520/1	135	1	015200101
1520/2	235	1	015200102

	A Max mm	L1 mm
1520/1	110	85
1520/2	160	140

1521/1 - 1521/2

estrattori a tre griffe reversibili

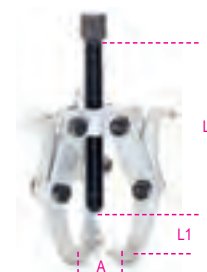

	L mm		
1521/1	135	1	015210101
1521/2	235	1	015210102

	A Max mm	L1 mm
1521/1	110	90
1521/2	160	140

Beta

1529

estrattore per pulegge multigola

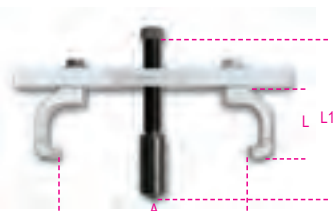

A	L	L1
min+Max	min+Max	min+Max
mm	mm	mm
24÷240	60÷95	90÷135

260x210x60 mm - 2,6 kg

1529PI

estrattore universale per puleggia pompa iniezione

- permette un rapido e preciso smontaggio della puleggia pompa iniezione carburante.
- particolarmente indicato per Fiat, Ford, Volkswagen, Citroen e Peugeot

Include 3 coppie di viti per serrare l'estrattore alla puleggia:
 M6 x 1.0 x 49 mm
 M7 x 1.0 x 75 mm
 M8 x 1.25 x 76 mm



1529PI

1 015290051

1530/C5

kit per estrazione mozzi e cuscinetti ruote a 3, 4, 5 fori

Il kit comprende:

- 1 flangia universale 96÷138 mm
- 1 vite idraulica da 12 tonnellate
- 1 massa battente da 2,8 kg indispensabile per mozzetti senza bullone di fissaggio centrale



1530/C5

1 015300300

760x320x120 mm - 11,5 kg

1532

utensile per rimozione guarnizioni e paraoli



1532

2 015320001

1533/...

tiranti per separatori 1534



	L	
	mm	
1533/2	150	1 015330002
1533/3	210	1 015330003
1533/4	315	1 015330004
1533/5	305	1 015330005

	A	L1
	min+Max	mm
	mm	mm
1533/2	45÷130	110
1533/3	85÷225	175
1533/4	80÷285	175
1533/5	145÷370	235

1533PR/1 - 2 - 3

prolunghe per tiranti 1533



1533PR/1	1 015330011
1533/2	
1533PR/2	1 015330012
1533/3	
1533PR/3	1 015330013
1533/4-5	

1534/...

separatori

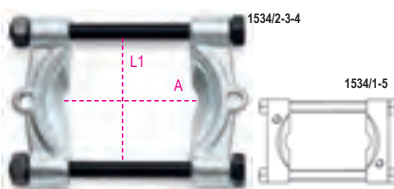

	A	
	min+Max	
	mm	mm
1534/1	5÷60	88
1534/2	12÷75	118
1534/3	22÷115	160
1534/4	25÷155	205
1534/5	30÷220	290

	A	L1
	min+Max	mm
	mm	mm
1534/1	5÷60	88
1534/2	12÷75	118
1534/3	22÷115	160
1534/4	25÷155	205
1534/5	30÷220	290

1535/C...

estrattori combinati



1535/C1

1 015350001

1533/2
1533PR/1
1534/1

260x180x40 mm - 2,5 kg

1535/C2

1 015350002

1533/2
1533PR/1
1534/2

260x180x40 mm - 2,8 kg

1535/C3

1 015350003

1533/3
1533PR/2
1534/3

380x280x55 mm - 8,0 kg

1535/C4

1 015350004

1533/4
1533PR/3
1534/4

420x380x65 mm - 14,8 kg

1535/C5

1 015350005

1533/5
1533PR/3
1534/5

530x510x85 mm - 27,4 kg

1539

tiralamiere a percussione



1539

1 015390001

1540

estrattore a percussione

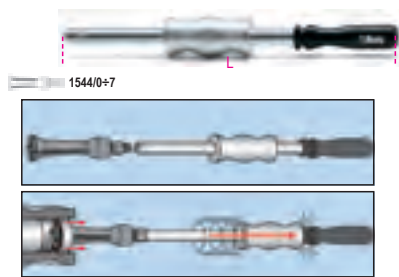

1540	L mm	Ø mm	1544		
	390	M10	0÷7	1	015400001

1542/1 - 1542/2

estrattori per griffe ed espansori



	A	1544		
	min+Max			
1542/1	35÷75	0÷7	1	015420001
1542/2	60÷130	9C-10C	1	015420002

	L	L1
	mm	mm
1542/1	140	140
1542/2	175	160

1544/...

espansori a settori per interni

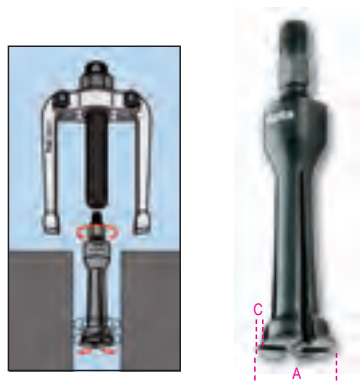

	C	Ø		
	mm			
1544/0	0,25	M10	1	015440100
A= 5÷7				
1544/A	0,80	M10	1	015440105
A= 7÷9				
1544/1	0,80	M10	1	015440110
A= 9÷12				
1544/2	1,15	M10	1	015440120
A= 13÷17				
1544/2B	1,00	M10	1	015440121
A= 14÷19				
1544/3	1,70	M10	1	015440130
A= 16÷21				
1544/4	1,65	M10	1	015440140
A= 20÷25				
1544/5	2,00	M10	1	015440150
A= 25÷30				
1544/6	3,00	M10	1	015440160
A= 30÷37				
1544/7	3,80	M10	1	015440170
A= 38÷45				
1544/9C	2,60	G 3/8"	1	015440189
A= 40÷75				
1544/10C	7,30	G 3/8"	1	015440199
A= 70÷115				

1545/C5M

estrattore 1542/1 con 5 espansori 1544



1545/C5M		1	015450011
----------	--	---	-----------

1542/1	● 24 mm
1544/1	9÷12 mm
1544/2	13÷17 mm
1544/3	16÷21 mm
1544/4	20÷25 mm
1544/5	25÷30 mm

265x180x45 mm - 2,4 kg

1547/C6

estrattori per cuscinetti con false sfere

Cuscinetti:
1547/1
6011-6014, 6206-6211, 6303-6308, 6403-6405
1547/2
6004-6010, 6200-6205, 6300-6304

• utilizzabile solo dopo aver "sgabbiato" le sfere.



1547/C6		1	015470006
---------	--	---	-----------

420x185x60 mm - 3 kg

1547KP

set di 3 coppie di terminali a falsa sfera



	Ø		
	mm		
1547KP/1	9-11-12,5	1	015470106
1547KP/2	5-6-8	1	015470206

1547P

prolunghe esagonali



	L			
	mm			
1547 P/1	205	1547/1	1	015470101
1547 P/2	102	1547/2	1	015470201

1547PC/2

prolunghe tonde corte



	L			
	mm			
1547PC/2	42	1547/2	1	015470202

1547PL/2

prolunghe tonde lunghe



	L			
	mm			
1547PL/2	106	1547/2	1	015470203

1549

kit per smontaggio e montaggio ammortizzatori a doppio effetto con rientro a gas

permette di mantenere lo stelo in estensione durante il montaggio delle molle



1549		1	015490001
------	--	---	-----------

310x270x110 mm - 3 kg

1550U

smonta ammortizzatori pneumatico per autoveicoli, SUV e veicoli commerciali

CE

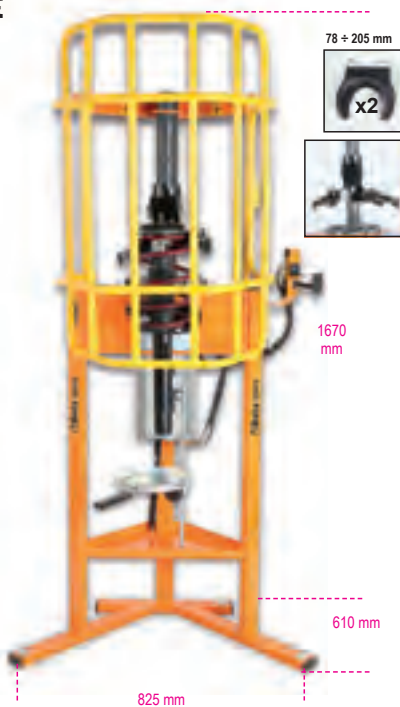

MAGGIOR POTENZA: potenza spinta massima 2 ton (10 bar)
SISTEMA UNIVERSALE DI PRESA SUPERIORE: consente con un'unica piastra adattabile superiore di comprimere tutti i diametri di molla sia destrorse che sinistrorse
SISTEMA DI SICUREZZA ATTIVA SULLA MOLLA: attraverso il gancio di sicurezza e le 3 valvole di blocco è garantito il corretto posizionamento/alloggiamento della molla mantenendo tale posizione per tutta l'operazione di compressione. In caso di posizionamento "non conforme" della molla il sistema ferma la macchina.
GRIGLIA DI PROTEZIONE "FULL BODY": garantisce la massima sicurezza e copertura della zona di lavoro
AZIONAMENTO CON LEVA DI COMANDO: maggior precisione e sensibilità durante la fase di compressione
POSIZIONE DI LAVORO: altezza di lavoro sulla staffa posteriore alzata fino a 875 mm

Fornito di 2 staffe inferiori per diametri 78-205 mm

DATI TECNICI

Potenza spinta: 2 ton (10 bar) - 1.6 ton (8 bar) - 1.2 ton (6 bar)
 Corsa di compressione molla: 335 mm

1550U

1 015500010

1550U/S...

staffa inferiore per 1550U



	Ø mm	
1550U/S130	78÷130 mm	1 015500014
1550U/S182	105÷182 mm	1 015500015
1550U/S205	125÷205 mm	1 015500016

1550U/SS187

staffa sinistrorsa per 1550U

particolarmente indicata per molle con profilo sinistro tipo Nissan Qashqai e Renault Koleos



1550U/SS187

1 015500018

1550U/M

morsa per smonta ammortizzatori 1550U

permette il bloccaggio dello stelo dell'ammortizzatore



1550U/M

1 015500021

1555/Q

pressore per molle ammortizzatori MacPherson ed equivalenti

spinta massima 1500 Kg

CE

1/2

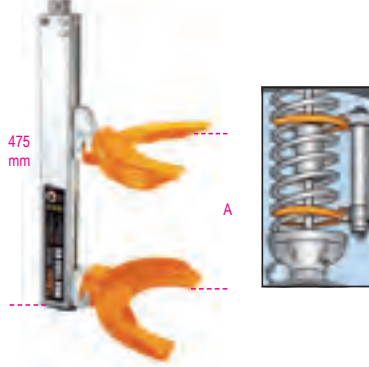

A	Ø	
min+Max mm	min+Max mm	
65÷354	80÷195	1 015550006

1555/QS

pressore per molle ammortizzatori Mac Pherson ed equivalenti

Dotato di protezioni in plastica per l'utilizzo in morsa

CE



A	Ø	
min+Max mm	min+Max mm	
70÷300	90÷205	1 015550005

1555S/MRC-C

staffa per ammortizzatori Mercedes W203, W209 (Classe C e E) per 1555Q e 1555/QS



1555S/MRC-C

1 015550301

1555S/BMW-RNT

staffa per ammortizzatori BMW E39, E46 e Renault Megane II per 1555Q e 1555/QS



1555S/BMW-RNT

1 015550303

1555C

pressore telescopico per molle ammortizzatori con 4 staffe e barra di torsione

12"



A	Ø	
min+Max mm	min+Max mm	
80÷225	90÷160	25000 8,5

1 015550202

1556/1A

coppia di pressori per molle ammortizzatori

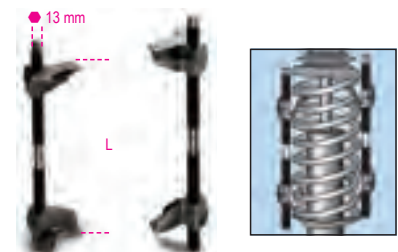

min L Max mm
65÷320

1 015560101

1556/2A

coppia di pressori per molle ammortizzatori

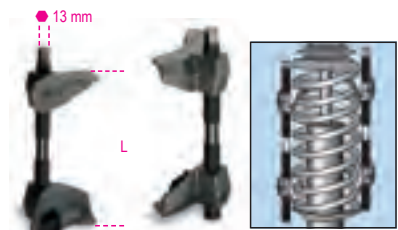

min L Max mm
65÷200

1 015560102

1557

chiavi a bussola Macchina
per perni balestre Truck



L mm	L1 mm	
37	28	1 015570137
46	34	1 015570146
56	34	1 015570156

1557V

chiave a bussola Macchina
per perni balestre Truck Volvo



mm	
27	1 015570299

1557/S3

serie di 3 chiavi
per ghiera ammortizzatori

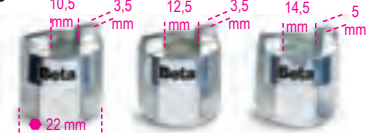

1557/S3	
1	015570010

1559

estrattori per snodi sferici



	A Max mm	Ø mm	
1559/22	50	18÷22	1 015590001
1559/36	90	36	1 015590036
1559/45	115	45	1 015590045

1559V/8T

vite idraulica per estrattore snodi sferici
1559/36 e 1559/45

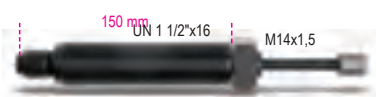

Nm	t	
80000	8	1 015590145

1560/1 - 1560/2

estrattori per snodi sferici
modello professionale



	A min+Max mm	Ø mm	
1560/1	12÷50	20	1 015600001
1560/2	60÷85	20	1 015600002

1560A

estrattore per snodi sferici



1560A	
1	015600601

1561/...

estrattori per snodi sferici



	L mm	A mm	Ø mm	
1561/1	39	36,6	18	1 015610001
1561/2	47	45,7	25	1 015610002
1561/3	63	62	30	1 015610003
1561/4	75	63	40	1 015610004

1562D

estrattore per snodi sferici

Fornito con 2 viti per l'estrazione di giunti sospensione e sterzo



A max mm	Ø mm	mm	L mm	
50	39	26	155	1 015620239

1565/1 - 2 - 3

estrattori a percussione
per snodi sferici



	Ø mm	L1 mm	
1565/1	18	65	1 015650001
1565/2	23	65	1 015650002
1565/3	30	88	1 015650003

1566N

attrezzo per smontaggio/montaggio
braccetti sterzo



Ø x L mm	mm		
28÷35 x 400	27	12"	1 015660005
35÷45 x 190	27	-	1 015660008
35÷45 x 400	27	12"	1 015660010

1566/G01

estrattore per giunti omocinetic



L mm	A mm	Ø1 mm	Ø2 mm	
250	115	29	36	1 015660052

1566P

pinza per anelli elastici
millerighe semiassi
la pinza comprime l'anello elastico semplificando
l'inserimento del semiassie nel giunto omocinetico



L mm	A Max mm	
280	36	1 015660091

1567

leva per estrazione testine braccio oscillante
e ammortizzatori dal montante

Utilizzabile da un solo operatore



A mm	B min+Max mm	
1060	100÷300	1 015670001

1568/C15

kit per smagliatura e ribaditura catene

Ø 3-4-5 + kit Regina



1568/C15	
1	015680015

420x185x60 mm

1568R/CS3

cacciaspina per smagliatene



1568R/CS3 1 015680503

1569/A

assortimento di utensili per l'estrazione e l'introduzione di: silent block ponte posteriore, paraoli albero motore e cuscinetti ruota

• le boccole possono essere utilizzate sia direttamente sul veicolo che alla pressa idraulica

• il kit comprende:

4 barre filettate: M10-M12-M14-M16

4 rondelle

boccole per diametri da 44 a 82 mm



1569/A 1 015690011

530x415x115 mm

1569/F

assortimento di utensili per l'estrazione e l'introduzione dei silent block di Fiat Panda, Panda 4x4, Panda Metano e Cross, Fiat 500, Ford Ka e Opel Adam



1569/F 1 015690021

1569CP

inseritori a percussione per cuscinetti conici e paraoli

regolazione rapida

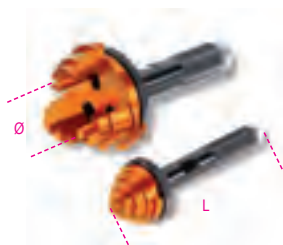

	Ø min+Max mm	L mm	
1569 CP/50	9,5÷50	130	1 015690750
1569 CP/90	18÷90	145	1 015690790

1570/3

martinetto idraulico per estrattori



t	L mm	L1 mm	• mm	
30	243	36	19	1 015700003

1580/8I

estrattore universale idraulico a due griffe

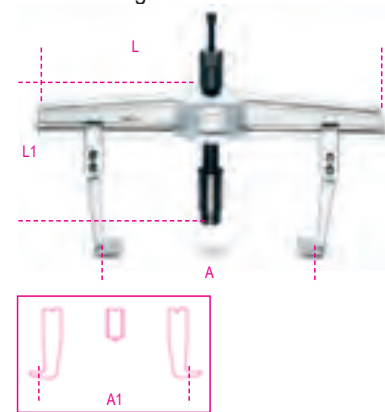

1580/8I 1 015800008

	A min+Max mm	L mm	L1 mm	A1 min+Max mm	N Max
1580/8I	170÷640	715	280	260÷715	180000

1580GL

griffe tipo lungo per estrattori 1580/8I - 1500/8



	L mm	
1580GL/8A	300	1 015800227
1580GL/8B	400	1 015800228
1580GL/8C	500	1 015800229

1585/5I - 6I - 7I

estrattori a tre griffe per azionamento idraulico

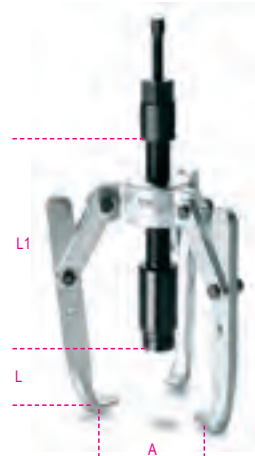

1585/5I 1 015850005
1585/6I 1 015850006
1585/7I 1 015850007

	A min+Max mm	L1 mm	L mm	N Max
1585/5I	50÷350	135	280	150000
1585/6I	50÷350	235	280	150000
1585/7I	50÷350	335	280	150000

1585GI/5 - 6 - 7

griffe per estrattori idraulici 1585/5I - 1585/6I - 1585/7I

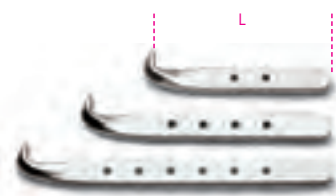

	L mm	
1585GI/5	135	1 015850205
1585GI/6	235	1 015850206
1585GI/7	335	1 015850207

1589VI

vite idraulica per estrattori 1580/8I e 1585/5I - 1585/6I - 1585/7I

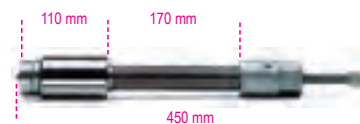

1589VI 1 015890001

1589PI/50 - 100 - 150

prolunghe per vite idraulica



	L mm	L1 mm	
1589PI/50	50	70	1 015890005
1589PI/100	100	120	1 015890010
1589PI/150	150	170	1 015890015

1590

morsetti standard



A max mm	L1 mm		
60	55	2	015900305
80	65	2	015900307
100	65	2	015900310
120	85	2	015900312
150	95	2	015900315

1591

stretti a vite

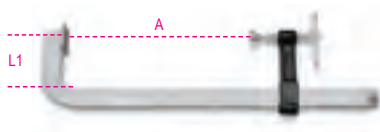

A mm	A max mm	L1 mm		
200	200	80	2	015910020
300	310	85	2	015910030
400	410	85	2	015910040
500	500	95	2	015910050
600	600	95	2	015910060
800	800	95	2	015910080
1000	1000	110	2	015910100

1593

serragianti a vite

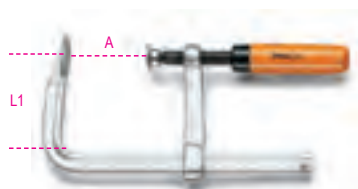

A mm	A max mm	L1 mm		
160	170	80	2	015930016
200	240	100	2	015930020
300	320	145	2	015930030

1594

serragianti a leva

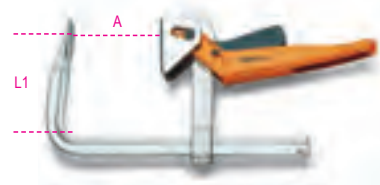

A mm	A max mm	L1 mm		
200	240	145	1	015940020
250	290	145	1	015940025
300	340	145	1	015940030
400	430	150	1	015940040
500	530	150	1	015940050
600	630	150	1	015940060

1595

serragianti a vite

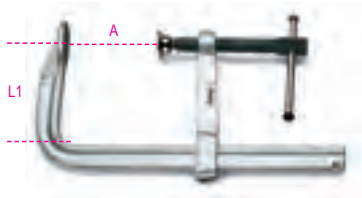

A mm	A max mm	L1 mm		
200	230	100	2	015950020
250	270	120	2	015950025
300	330	120	2	015950030
400	420	120	2	015950040
500	520	125	2	015950050
600	620	125	2	015950060
800	820	125	1	015950080
1000	1030	125	1	015950100

1599F

morsetti paralleli da banco forgiati

con piano e guide temprate



L1 mm	BxH mm	Ø mm		
100	92x46	11	1	015990100
125	108x54	13	1	015990125
150	125x62	13	1	015990150
175	140x70	15	1	015990175

1599P

morsetti paralleli da banco forgiati

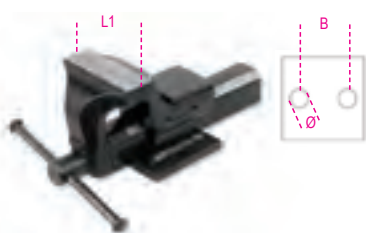

L1 mm	B mm	Ø mm		
100	92	11	1	015990000
125	108	13	1	015990025
150	130	15	1	015990050

1599B

basi girevoli per morsetti 1599P



	1599P		
1599B100	100	1	015990810
1599B125	125	1	015990812
1599B150	150	1	015990815

1599T

morsetti paralleli da trapano



L1 mm	B mm	Ø mm		
80	111	11	1	015990480
100	120	13	1	015990500

1599G

coppie di copriangoste in alluminio



A mm		
100	1	015990910
125	1	015990912
150	1	015990915
180	1	015990917

1601/PC

pinza a cricchetto per capicorda telefonia e trasmissione dati



RJ11-RJ12-RJ45

2	016010011
---	-----------

1602

pinza per capicorda preisolati modello leggero



mm²
0,75+6

5	016020001
---	-----------

1602/C9T

pinza per capicorda 1602
con assortimento di 450 capicorda



1602/C9T 1 016020013

1602		n.
1602	R/6,3	50
1620	B/6,3	50
1620	G/6,3	50
1624	R/6,3	50
1624	B/6,3	50
1624	G/6,3	50
1628	R/1,6	50
1628	B/2,3	50
1628	G/3,6	50

420x350x35 mm - 1,5 kg

1602A

pinza per capicorda preisolati
modello standard

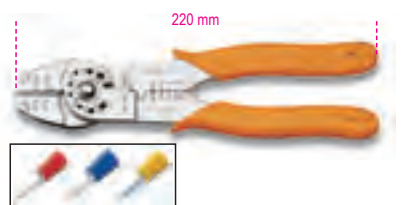

mm²
0÷6 2 016020005

1603

pinza per capicorda
non isolati modello leggero

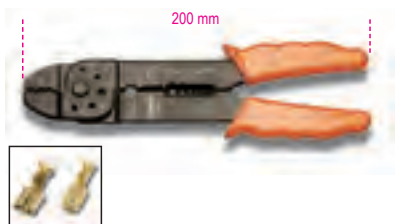

mm²
1,25÷5,5 5 016030001

1603A

pinza per capicorda non isolati chiusi
modello standard

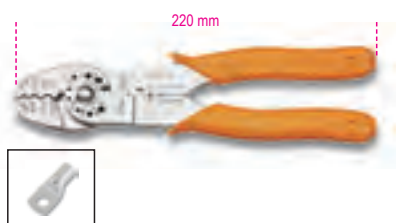

mm²
0÷8 2 016030005

1603B

pinza per capicorda non isolati aperti
modello standard



mm²
0÷8 2 016030010

1604

pinza autobloccante
per capicorda preisolati



mm²
0,5÷6 1 016040001

1604/C9T

pinza per capicorda 1604
con assortimento di 450 capicorda



1604/C9T 1 016040013

1604		n.
1604		1
1620	R/6,3	50
1620	B/6,3	50
1620	G/6,3	50
1624	R/6,3	50
1624	B/6,3	50
1624	G/6,3	50
1628	R/1,6	50
1628	B/2,3	50
1628	G/3,6	50

420x350x35 mm - 2 kg

1605

pinza autobloccante
per capicorda non isolati

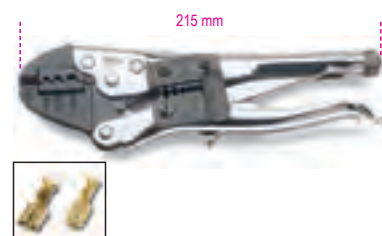

mm²
0,5÷6 1 016050001

1606

pinza a grande effetto
per capicorda a tubetto



mm²
0,5÷6 1 016060001

1606A

pinza per capicorda a tubetto



mm²
1606A6 0,5÷6 1 016060010
1606A16 6÷16 1 016060016



1606A/C9

Pinza per capicorda a tubetto 1606A6 con assortimento di 450 capicorda



1606A/C9 1 016060100

1606A	n.
1632 W/0,5K	50
1632 N/1,5K	100
1632 B/2,5K	100
1632 G/4K	100
1632 Y/6K	100

420x350x35 mm - 2,5 kg

1607

pinza a grande effetto per connettori BNC per cavi coassiali RG 58, RG 59, RG 62, RG 71



1607 1 016070001

L	A	B
mm	mm	mm
220	73	19

1608

pinza per capicorda preisolati, con regolatore di pressione



1608 1 016080001

1608/C9T

pinza per capicorda 1608 con assortimento di 450 capicorda



1608/C9T 1 016080013

1608	n.
1620 R/6,3	50
1620 B/6,3	50
1620 G/6,3	50
1624 R/6,3	50
1624 B/6,3	50
1624 G/6,3	50
1628 R/1,6	50
1628 B/2,3	50
1628 G/3,6	50

420x350x35 mm - 2 kg

1608A

pinza a grande effetto per capicorda preisolati



1608A 1 016080005

1609

pinza per capicorda non isolati



1609 1 016090001

1609A

pinza a grande effetto per capicorda non isolati



1609A 1 016090005

1609B

pinza per capicorda non isolati

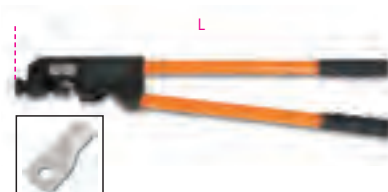

1609B 1 016090101

1609C/C5

pinza oleodinamica per capicorda

crimpature esagonali



1609C/C5 1 016090210

500x300x110 mm - 4 kg

1609M

coppia di matrici per 1609C

crimpature esagonali



1609M	mm ²	n.
1609M/16	10-16	1 016090221
1609M/35	25-35	1 016090223
1609M/70	50-70	1 016090225
1609M/120	95-120	1 016090227
1609M/150	150	1 016090229
1609M/185	185	1 016090231
1609M/240	240	1 016090233

1610

terminali con attacco tondo

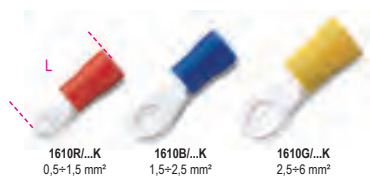

	D mm	mm ²	L mm		
1610R/4K	4	0,5-1,5	17	1	016100104
1610R/5K	5	0,5-1,5	20	1	016100105
1610B/5K	5	1,5-2,5	22	1	016100115
1610B/6K	6	1,5-2,5	27	1	016100116
1610B/8K	8	1,5-2,5	27	1	016100118
1610G/6K	6	2,5-6	31	1	016100126
1610G/8K	8	2,5-6	34	1	016100128

I prezzi indicati sono relativi a 100 pezzi

1614

terminali a puntale

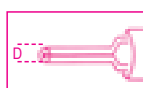
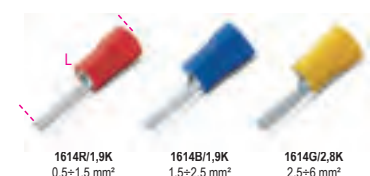

	D mm	mm ²	L mm		
1614R/1,9K	1,9	0,5-1,5	21	1	016140101
1614B/1,9K	1,9	1,5-2,5	21	1	016140102
1614G/2,8K	2,8	2,5-6	25	1	016140103

I prezzi indicati sono relativi a 100 pezzi

1616

terminali cilindrici maschio



	D mm	mm ²	L mm		
1616R/4K	4	0,5-1,5	21	1	016160104

I prezzi indicati sono relativi a 100 pezzi

1618

terminali cilindrici femmina

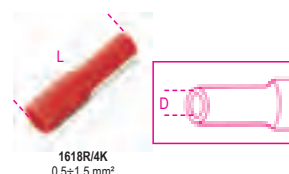

	D mm	mm ²	L mm		
1618R/4K	4	0,5-1,5	24	1	016180104

I prezzi indicati sono relativi a 100 pezzi

1620

raccordi maschio

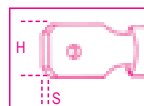
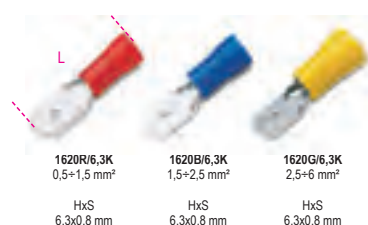

	mm ²	L mm		
1620R/6,3K	0,5-1,5	22	1	016200101
1620B/6,3K	1,5-2,5	22	1	016200102
1620G/6,3K	2,5-6	22	1	016200103

I prezzi indicati sono relativi a 100 pezzi

1622

raccordi femmina

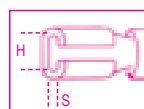
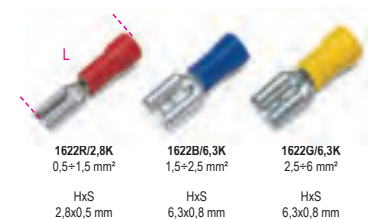

	mm ²	L mm		
1622R/2,8K	0,5-1,5	20	1	016220101
1622R/6,3K	0,5-1,5	22	1	016220103
1622B/6,3K	1,5-2,5	22	1	016220106
1622G/6,3K	2,5-6	22	1	016220108

I prezzi indicati sono relativi a 100 pezzi

1624

raccordi femmina isolati

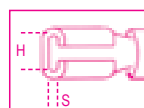

	mm ²	L mm		
1624R/6,3K	0,5-1,5	23	1	016240102
1624B/6,3K	1,5-2,5	24	1	016240104
1624G/6,3K	2,5-6	24	1	016240105

I prezzi indicati sono relativi a 100 pezzi

1628

connettori di linea

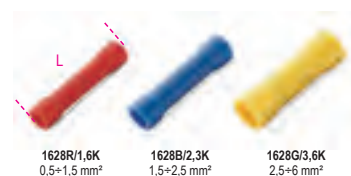

	D mm	mm ²	L mm		
1628R/1,6K	1,6	0,5-1,5	25	1	016280101
1628B/2,3K	2,3	1,5-2,5	26	1	016280102
1628G/3,6K	3,6	2,5-6	26	1	016280103

I prezzi indicati sono relativi a 100 pezzi

1630

connettori rapidi



	mm ²	L mm		
1630R/K	0,5-1,5	20	1	016300101
1630B/K	1,5-2,5	20	1	016300102

I prezzi indicati sono relativi a 100 pezzi

1632

terminali a tubetto



	mm ²	L mm		
1632W/0,5K	0,5	14	1	016320005
1632G/0,75K	0,75	14	1	016320007
1632R/1K	1	14	1	016320010
1632N/1,5K	1,5	15	1	016320015
1632B/2,5K	2,5	15	1	016320025
1632G/4K	4	17	1	016320040
1632Y/6K	6	20	1	016320060

I prezzi indicati sono relativi a 100 pezzi

1634

terminali doppi a tubetto



	mm ²	L mm		
1634W/0,5K	0,5	15	1	016340005
1634G/0,75K	0,75	15	1	016340007
1634R/1K	1	15	1	016340010
1634N/1,5K	1,5	16	1	016340015
1634B/2,5K	2,5	19	1	016340025
1634G/4K	4	23	1	016340040
1634Y/6K	6	26	1	016340060

I prezzi indicati sono relativi a 100 pezzi

1639NS-N

nastro isolante nero



L m	10	016390025
25		

1639S

sonda tirafili in nylon

con teste intercambiabili



L m	∅ mm	1	016390010
10	4		

1640K

foralamiera oleodinamica con 4 fustelle

forature tonde
22,5-25,5-32,5-55,5 mm



1640K	1	016400001
470x400x100 mm		

1640

punzonatrice per lamiera



1640	1	016400100

1640A

adattatore per 1640



1640A	1	016400080

1640P

perno filettato per 1640



	∅ mm	1	016400088
1640P/9	9,5		
1640P/19	19		016400089

1640Q

fustelle quadre per 1640
con perno incluso



1640Q/45	45x45	1	016400065

1640T

fustelle tonde per 1640

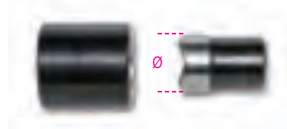

	∅ mm	1	016400022
1640T/22,5	22,5		
1640T/25,5	25,5		016400025
1640T/32,5	32,5		016400032
1640T/55,5	55,5		016400055

1650

calibro a corsoio
lettura ventesimale



UNI EN ISO 13385-1DIN 862

A max mm	L mm	1	016500001
150	235		
200	290		016500002

1650FD

calibro a corsoio per dischi freni
lettura decimale

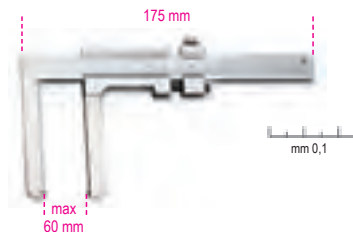

1650FD	1	016500050

1650FT

calibro a corsoio per tamburi freni
lettura ventesimale



	A max mm	L mm	1	016500060
1650FT	350	438		
1650FT/2	500	550		016500070

1651DGT

calibro digitale a corsoio
lettura centesimale



UNI EN ISO 13385-1DIN 862CE

A Max mm	L mm	1	016510111
150	225		
200	285		016510112

1651DGT/IP

calibro digitale a corsoio
lettura centesimale grado di protezione IP67

Totale protezione dalle polveri e dai liquidi, funziona anche in caso di totale immersione dello strumento.



UNI EN ISO 13385-1 DIN 862CE

1651DGT/IP	1	016510611
270x115x35 mm - 450 g		

1652

calibro a corsoio con comparatore
lettura cinquantalesimale



UNI EN ISO 13385-1DIN 862

1652



1 016520016

1654

calibri a corsoio
lettura cinquantalesimale



UNI EN ISO 13385-1DIN 862

A max mm	L mm
200	330
300	410



1 016540020
1 016540030

1654DGT

calibro digitale a corsoio
lettura centesimale

- Lettura centesimale
- Bloccaggio a vite del corsoio
- Conversione mm/pollici

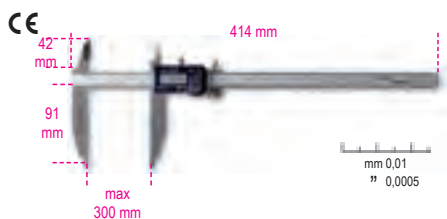

UNI EN ISO 13385-1DIN 862CE

1654DGT



1 016540111

1656

calibri a corsoio di profondità
lettura cinquantalesimale



UNI EN ISO 13385-2DIN 862

A max mm	L mm
200	260
300	360



1 016560020
1 016560030

1657DGT/2

calibro a corsoio di profondità digitale
lettura centesimale

- Lettura centesimale
- Bloccaggio a vite del corsoio
- Conversione mm/pollici

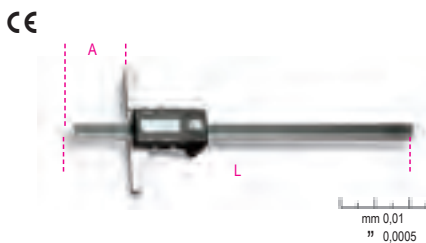

UNI EN ISO 13385-2DIN 862CE

A max mm	L mm
200	270



1 016570002

1658/...

micrometri per esterni
lettura centesimale



DIN 863/II

A mm	
1658/25	0÷25
1658/50	25÷50
1658/75	50÷75
1658/100	75÷100

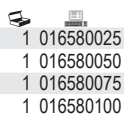

1658/C4

assortimento di 4 micrometri 1658



DIN 863

1658/C4



1 016580001

1658/25	0÷25 mm
1658/50	25÷50 mm
1658/75	50÷75 mm
1658/100	75÷100 mm

365x245x35 mm - 2,5 kg

1658DGT

micrometri digitali per esterni
lettura millesimale



DIN 863CE

A mm	
1658DGT/25	0÷25
1658DGT/50	25÷50



1 016580325
1 016580350

1658SP/1

supporto per micrometro

- Morsetto con inserti in gomma
- Rotazione a 90°



1658SP/1



1 016580910

1659

misuratore di spessore
con comparatore
lettura centesimale
C = Campo di comparazione

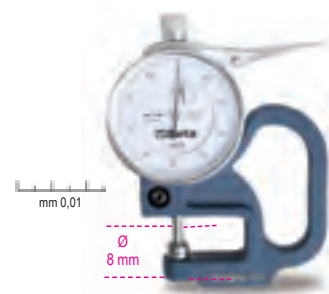

C mm	
1659	0÷10



1 016590001

1662/1 - 1662/2

comparatori
lettura centesimale
C = Campo di comparazione



DIN 878

C mm	
1662/1	0÷5
1662/2	0÷10



1 016620001
1 016620010

1662DGT

comparatore digitale
lettura centesimale
C = Campo di comparazione



DIN 878

C mm	
1662DGT	0÷12,5



1 016620310

1662AN

comparatore a tastatore orientabile
lettura centesimale

C = Campo di comparazione



DIN 2270

1662AN	C mm	1	016620200
	0=0,8		

1662SP0

supporto a base magnetica



1662SP0	1	016620800

1662SP2

supporto a base magnetica
snodato



1662SP2	1	016620910

1666

squadre semplici
in acciaio inossidabile
rettificate e lappate



DIN 875/0

L mm	L1 mm	1	016660210
100	70		
150	100		
200	130		
250	165		
300	200		

1666A

squadre a cappello
in acciaio inossidabile
rettificate e lappate



DIN 875/0

L mm	L1 mm	1	016660110
100	70		
150	100		
200	130		
250	170		
300	200		

1668A

squadre a cappello
in acciaio normalizzato
rettificate



DIN 875/2

L mm	L1 mm	2	016680110
100	70		
150	100		
200	130		
250	165		
300	176		

1670

squadre semplici
in acciaio non normale



L mm	L1 mm	3	016700010
100	70		
150	100		
200	130		
250	160		
300	180		
400	200		
500	250		
600	300		
750	375		
1000	500		

1670A

squadre a cappello
in acciaio non normale



L mm	L1 mm	3	016700110
100	70		
150	100		
200	130		
250	160		
300	180		
400	200		
500	250		
600	300		
800	400		
1000	500		

1672

squadra falsa
a lama orientabile e scorrevole
lama e base in acciaio

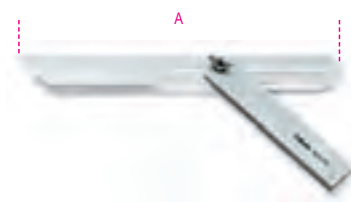

A mm	2	016720030
300		

Beta

1672A

squadre false
a lama orientabile e scorrevole
lama in acciaio cromata
base in alluminio

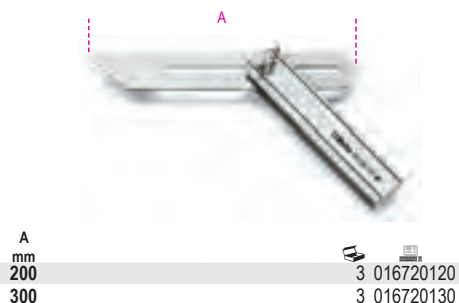

A mm		
200	3	016720120
300	3	016720130

1674A

squadre per falegnami
lama in acciaio, base in alluminio
doppia scala millimetrata

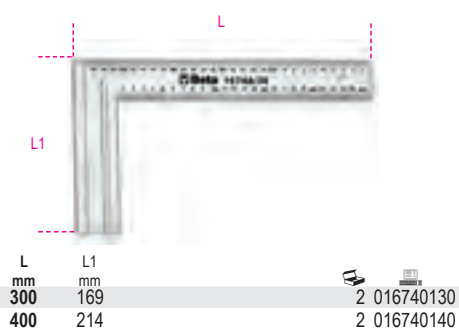

L mm	L1 mm	
300	169	2 016740130
400	214	2 016740140

1676

goniometri semplici
in acciaio

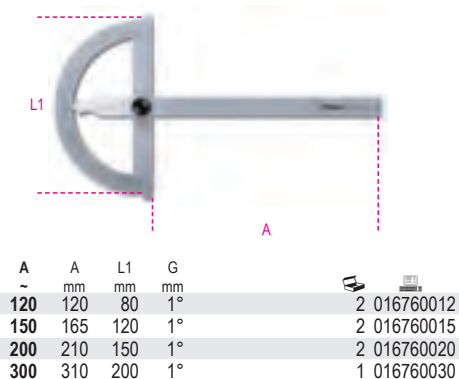

A mm	A mm	L1 mm	G mm	
120	120	80	1°	2 016760012
150	165	120	1°	2 016760015
200	210	150	1°	2 016760020
300	310	200	1°	1 016760030

1678/C3

rapportatore d'angoli
in acciaio inossidabile

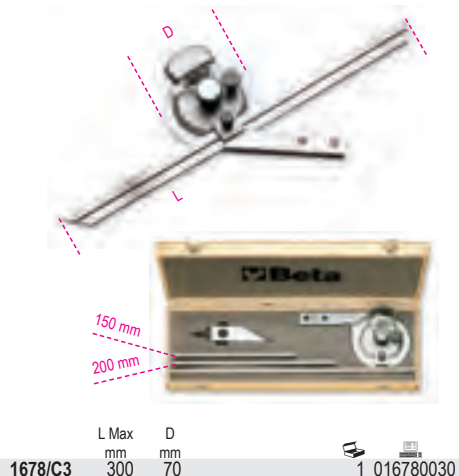

L Max mm	D mm	
1678/C3	300	70

1679

calibro a tracciare con rotella
in acciaio inossidabile
lettura decimale

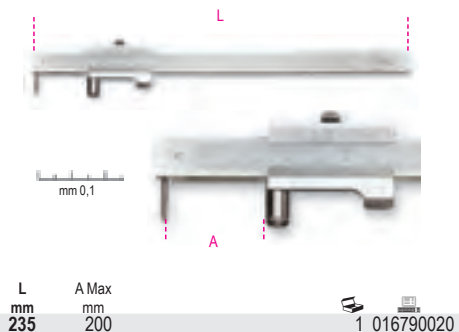

L mm	A Max mm	
235	200	1 016790020

1679/PR

punta di ricambio per calibro 1679



1679/PR	1	016790021
---------	---	-----------

1680

compasso a verga
corpo e punte di tracciatura
in acciaio temprato

• Regolazione fine cinquantessimale

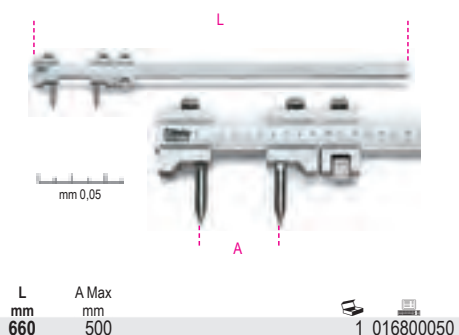

L mm	A Max mm	
660	500	1 016800050

1680A

compassi di precisione per interni

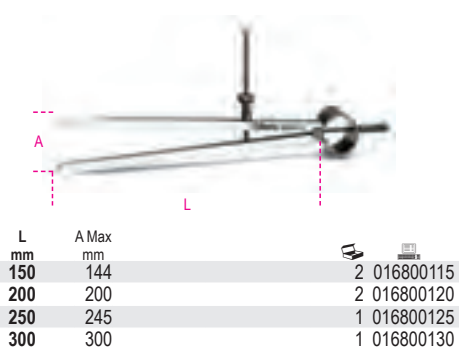

L mm	A Max mm	
150	144	2 016800115
200	200	2 016800120
250	245	1 016800125
300	300	1 016800130

1680B

compassi di precisione per esterni

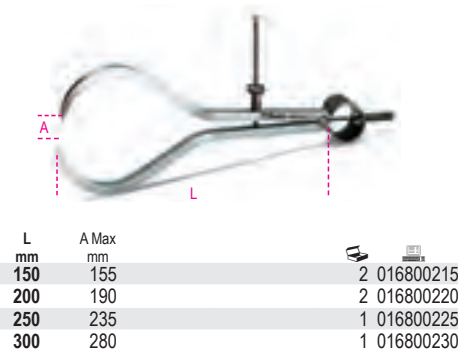

L mm	A Max mm	
150	155	2 016800215
200	190	2 016800220
250	235	1 016800225
300	280	1 016800230

1680C

compassi di precisione per tracciatori
punte diritte in acciaio temprato

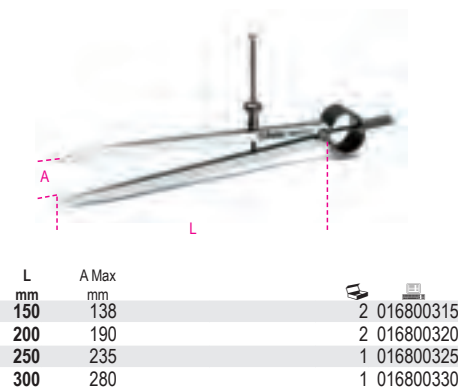

L mm	A Max mm	
150	138	2 016800315
200	190	2 016800320
250	235	1 016800325
300	280	1 016800330

1682

righe flessibili graduate
in acciaio inossidabile

• doppia scala millimetrata
• antiriflesso



L mm	H mm	\pm mm	
150	13	0,5	5 016820015
200	13	0,5	5 016820020
250	13	0,5	5 016820025
300	13	0,5	5 016820030
500	13	0,5	2 016820050
1000	13	0,5	2 016820100

1683

righe semirigide graduate
in acciaio inossidabile

• doppia scala millimetrata
• antiriflesso

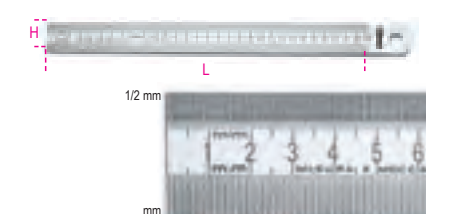

L mm	H mm	\pm mm	
300	30	1	5 016830030
500	30	1	2 016830050
1000	30	1	2 016830100
1500	30	1	1 016830150

Beta

1685/C7

assortimento di 7 strumenti per misurare e tracciare



1685/C7 1 016850110

	1650	160 mm
	1658/25	0+25 mm
	1670	100 mm
	1680C	150 mm
	1682	150 mm
	1688BC	165 mm
	1688BC/R	

320x210x37 mm - 1,2 kg

1687A

punta di precisione piegata a 90° con impugnatura



1687A L mm 153 L1 mm 80 1 016870120

1687AC

punta di precisione piegata corta con impugnatura



1687AC L mm 153 L1 mm 80 1 016870125

1687D

punta di precisione diritta con impugnatura



1687D L mm 153 L1 mm 80 1 016870110

1687U

punta di precisione ad uncino con impugnatura



1687U L mm 153 L1 mm 80 1 016870115

1687/S4

serie di 4 punte di precisione con impugnatura



1687/S4 1687A-1687AC 1687D-1687U 1 016870150

1688

punta per tracciare in acciaio temprato



1688 L mm 250 Ø mm 2 5 016880020

1688A

punta per tracciare in acciaio temprato con punte in carburo di tungsteno



1688A L mm 200 Ø mm 4 5 016880120

1688PC

punta per tracciare a penna in acciaio temprato cromato



1688PC L mm 150 Ø mm 1 1 016880300

1688PC/R

punta di ricambio per 1688PC

1688PC/R 1 016880310

1688M

matita per falegnami



1688M L mm 180 50 016880880

1690F

metro pieghevole in fibra di vetro classe di precisione III



1690F/2 L m 2 S mm 17 5 016900220

1690L

metro pieghevole in legno di betulla classe di precisione III



1690L/2 L m 2 S mm 17 5 016900200

1691BM

flessometri
cassa bimateriale in ABS antiurto
nastro in acciaio
classe di precisione II



1691BM/5 L m 5 S mm 25 1 016910205
1691BM/8 8 32 1 016910208
1691BM/10 10 32 1 016910210

1692

flessometri
cassa bimateriale in ABS antiurto
nastro in acciaio
classe di precisione II



1692/2 L m 2 S mm 16 5 016920052
1692/3 3 16 5 016920053
1692/5 5 19 5 016920055
1692/8 8 25 5 016920058

1694/L

rotelle metriche
cassa in ABS antiurto
nastro in fibra di vetro ricoperto in PVC
classe di precisione III

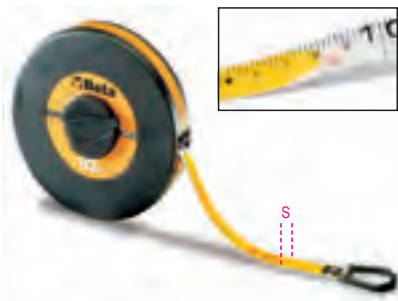

	L m	S mm		
1694/L10	10	13	1	016940110
1694/L20	20	13	1	016940120

1694A/L

rotelle metriche con impugnatura
cassa in ABS antiurto
nastro in fibra di vetro ricoperto in PVC
classe di precisione III



	L m	S mm		
1694A/L30	30	13	1	016940230
1694A/L50	50	13	1	016940250

1694B/L

rotella metrica con impugnatura
cassa in alluminio
nastro in acciaio smaltato
classe di precisione II



	L m	S mm		
1694B/L	50	12,5	1	016940350

1695XS

livella tascabile con base a "V"
magnetica in alluminio profilato
2 file infrangibili
precisione 1mm/m

- ideale per tubi e sezioni tonde in genere
- fornita con clip



L mm	H mm	S mm		
70	48,5	20	5	016950250

1696

livelle in alluminio profilato anodizzato
con file infrangibili
precisione 1mm/m



L mm	H mm	S mm		
200	50	19	2	016960002
400	50	19	2	016960004
500	50	19	2	016960005
600	50	19	2	016960006
800	50	19	2	016960008
1000	50	19	2	016960010

1696A

livelle in alluminio pressofuso
con 1 base rettificata a 2 file infrangibili
precisione 1 mm/m



L mm	H mm	S mm		
300	43	23	2	016960103
400	43	23	2	016960104
500	43	23	2	016960105
600	43	23	2	016960106
800	43	23	1	016960108
1000	43	23	1	016960110

1696B

livelle con base magnetica
in alluminio profilato
anodizzato a 2 file infrangibili
precisione 1 mm/m



L mm	H mm	S mm		
200	49	22	2	016960202
300	49	22	2	016960203
400	49	22	2	016960204
500	49	22	2	016960205
600	49	22	2	016960206

1696D

livelle in alluminio pressofuso con
impugnatura, (tranne la versione da 300 mm)
4 basi rettificcate 3 file infrangibili
precisione 1 mm/m



L mm	H mm	S mm		
300	47	25	2	016960353
400	47	25	2	016960354
500	47	25	2	016960355
600	47	25	2	016960356

1696S

stadi in alluminio con impugnatura
a due file infrangibili
precisione 1 mm/m

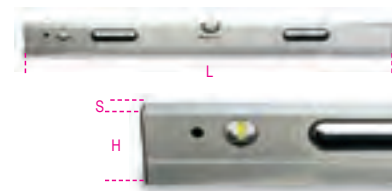

L mm	H mm	S mm		
1500	90	25	1	016960415
2000	90	25	1	016960420
2500	90	25	1	016960425
3000	90	25	1	016960430

1699L

livella lineare di precisione
in ghisa con base prismatica rettificata
a 2 file infrangibili
precisione 0,05 mm/m



DIN 877

	L mm	A mm		
1699L	200	49	1	016990002

1699L/1

livella lineare di precisione
in ghisa con base prismatica rettificata
a 2 file infrangibili
precisione 0,02 mm/m



DIN 877

	L mm	A mm		
1699L/1	200	49	1	016990005

1699Q

livelle quadre di precisione
in ghisa con 2 basi prismatiche
e 2 basi piane rettificate
a 2 file infrangibili
precisione 0,05 mm/m



DIN 877

L mm	A mm		
150	40	1	016990015
200	48	1	016990020

1700N

punte per edilizia



L mm	S mm		
250	16	5	017000005
300	16	5	017000006

1700N/PM

punte per edilizia
con paramano



L mm	S mm		
250	16	2	017000105
300	16	2	017000106

1701N

scalpelli per edilizia



L mm	A mm	S mm		
250	23	16	5	017010001
300	23	16	5	017010003

1701N/PM

scalpelli per edilizia
con paramano



L mm	A mm	S mm		
250	23	16	2	017010101
300	23	16	2	017010103

1701PMR

paramano per 1700N e 1701N

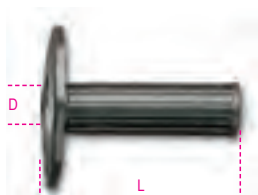

D mm	L mm		
16	115	1	017010206

1701NE/...

scalpelli per elettricisti



	SxL mm		
1701NE/3	10x200	5	017010406
1701NE/4	10x250	5	017010409

1702N

scalpelli a tagliante extrapiatto



A mm	SxH mm		
50	12x25	2	017020005
70	12x25	2	017020007

1702N/PM

scalpelli a tagliante extrapiatto
con paramano

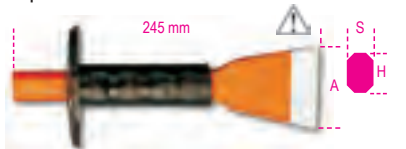

A mm	SxH mm		
50	12x25	2	017020105
70	12x25	2	017020107



Si raccomanda di raffreddare
frequentemente l'utensile durante
la riaffilatura.

1702PMR

paramano per 1702N



L mm			
115		1	017020200

1704

leve piegate per carpentieri

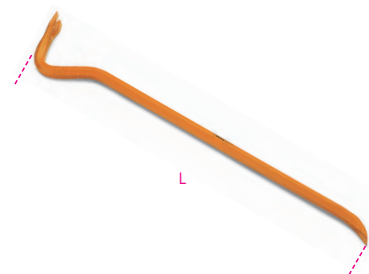

L mm			
500		2	017040050
600		2	017040060
800		2	017040080

1704A

leve con estremità a punta
e a scalpello

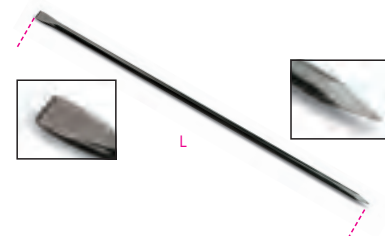

L mm			
1500		1	017040110
2000		1	017040120

1704C

leve con estremità a punta
e penna chiusa

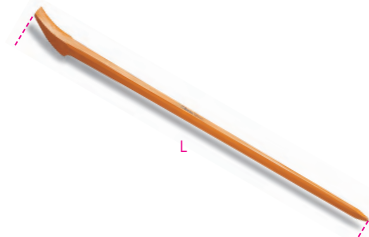

L mm			
1200		1	017040210
1400		1	017040212
1600		1	017040215

1705

traccialinea
in alluminio



L m			
1705	30	4	017050001

1705PT

polvere traccialinea



g
250

5 017050025

1706DGT

calibro digitale di profondità per battistrada pneumatici



1706DGT

1 017060011

1707

contafilletti

Per filetti metrici ISO a 60° e Whitworth a 55°



P (ISO)
0,25÷6

W
62÷4x1"

5 017070001

1707A/1 - 2 - 3

raggimetri

lame concave e convesse, in acciaio



R
mm
1707A/1 1,0÷7,0

2 017070007

1707A/2 7,5÷15

2 017070015

1707A/3 15,5÷25

2 017070025

1708/8 - 13 - 20

spessimetri

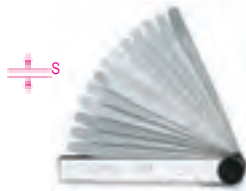

1708/8
S = 0,05±0,50 mm

5 017080008

1708/13
S = 0,05±1,00 mm

5 017080013

1708/20
S = 0,05±1,00 mm

5 017080020

1709/10 - 1709/18

spaccadadi



L mm A max mm
1709/10 90 17 (M10)
1709/18 108 25 (M16)

1 017090010
1 017090018

1710

spaccadadi idraulico



C min mm C max mm
7(M4) 22(M14)

1 017100001

1712E/1 - 2 - 3

flessibili magnetici

F = forza magnetica



L mm D mm F kg
1712E/1 420 7,5 0,5
1712E/2 530 15 1,8
1712E/3 532 19 3,0

2 017120011
2 017120012
2 017120013

1712E/L1

flessibile magnetico con illuminazione LED

F = forza magnetica
pile: 2X LR48

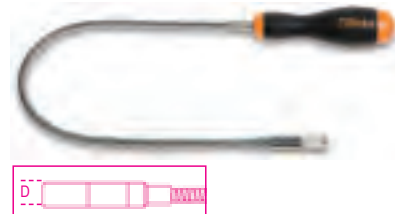

L mm D mm F kg
1712E/L1 500 11 0,75

2 017120111

1712E/R-L1

testine di ricambio per 1712E/L1, con LED e magnete

1712 E/R-L1

1 017120611

1712TF

magnete telescopico con testa flessibile

• Con pulitore per ugelli lavavetri
F= forza magnetica



L mm
150÷590

D mm
11

F kg
1

1 017120600

1713M

artigli prensili flessibili

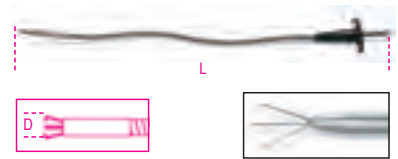

L mm D mm
500 7
1000 7

2 017130011
1 017130015

1714

specchietto rigido in materiale plastico



L mm D mm
1714 155 25

5 017140001

1715

specchietto telescopico articolato corpo in metallo cromato



L mm D mm
1715 180÷540 30

1 017150001

1715FL/A

specchietto flessibile rettangolare



L mm A mm B mm
1715FL/A 600 53 90

1 017150110

1715R/FL

kit di 2 specchietti di ricambio per 1715FL/A e 1715FL/B

1715 R/FL

1 017150151

1715FL/B

specchietto flessibile rettangolare con illuminazione
con pile: **2X AAA**



	L mm	A mm	B mm		
1715FL/B	553	53	90	1	017150115

1715B/R5L

kit di 5 lampadine di ricambio per 1715FL/B

1715 B/R5L	5	017150152
------------	---	-----------

1716A

punta angolata per usi generici



	L mm	L1 mm	■ mm		
1716A	240	125	6	3	017160040

1716P

raschietto per guarnizioni

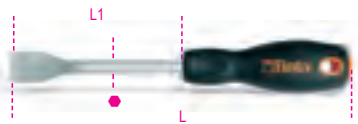

	L mm	L1 mm	● mm		
1716P	250	125	6	3	017160020

1716Q

punteruolo a punta quadra



	L mm	L1 mm	Ø mm		
1716Q	215	100	6	5	017160010

1716R

punteruolo a punta tonda

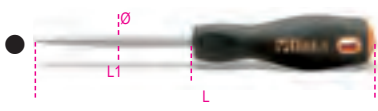

	L mm	L1 mm	Ø mm		
1716R	215	100	6	5	017160001

1716U

punta ad uncino per usi generici

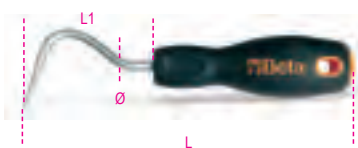

	L mm	L1 mm	Ø mm		
1716U	195	80	6	3	017160025

1717A

raschietti a due taglianti



	L mm	L1 mm	L2 mm		
1717A	150	70	260	2	017170015
	200	75	310	2	017170020
	250	100	360	2	017170025

1717B

raschietti a tre taglianti



	L mm	L1 mm	L2 mm		
1717B	150	75	260	2	017170115
	200	85	310	2	017170120
	250	100	360	2	017170125

1717C

raschietti piatti



	L mm	S mm	L1 mm		
1717C	150	18	270	2	017170215
	200	20	320	2	017170220
	250	25	370	2	017170225

1717D

raschietto piatto a tagliente frontale

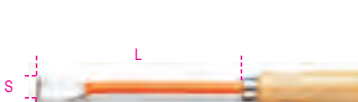

	L mm	S mm	L1 mm		
1717D	150	23	240	2	017170320

1718D...Q

lime quadre a taglio grossolano, senza impugnatura



	L mm	L' mm		
1718D6/Q	150	6	5	017180121
1718D8/Q	200	8	5	017180131
1718D10/Q	250	10	5	017180141

1718A...Q

lime quadre a taglio mezzodolce, senza impugnatura



	L mm	L' mm		
1718A6/Q	150	6	5	017180021
1718A8/Q	200	8	5	017180031
1718A10/Q	250	10	5	017180041

1718D...T

lime triangolari a taglio grossolano, senza impugnatura

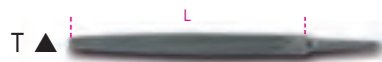

	L mm	L' mm		
1718D6/T	150	6	5	017180123
1718D8/T	200	8	5	017180133
1718D10/T	250	10	5	017180143

1718A...T

lime triangolari a taglio mezzodolce, senza impugnatura

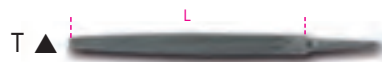

	L mm	L' mm		
1718A6/T	150	6	5	017180023
1718A8/T	200	8	5	017180033
1718A10/T	250	10	5	017180043

1718D...P

lime piatte a taglio grossolano, senza impugnatura

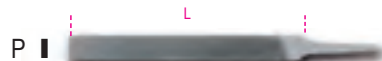

	L mm	L' mm		
1718D6/P	150	6	5	017180125
1718D8/P	200	8	5	017180135
1718D10/P	250	10	5	017180145

1718A...P

lime piatte a taglio mezzodolce, senza impugnatura

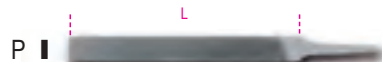

	L mm	L' mm		
1718A6/P	150	6	5	017180025
1718A8/P	200	8	5	017180035
1718A10/P	250	10	5	017180045

1718D...M

lime mezzotonde a taglio grossolano, senza impugnatura

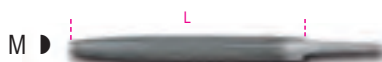

	L mm	L' mm		
1718D6/M	150	6	5	017180127
1718D8/M	200	8	5	017180137
1718D10/M	250	10	5	017180147

1718A...M

lime mezzotonde a taglio mezzodolce, senza impugnatura

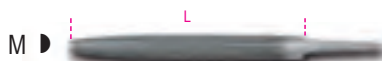

	L mm	L' mm		
1718A6/M	150	6	5	017180027
1718A8/M	200	8	5	017180037
1718A10/M	250	10	5	017180047

1718D...R

lime tonde a taglio **grossolano**, senza impugnatura

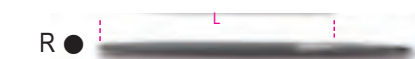

	L mm	L "		
1718D6/R	150	6	5	017180129
1718D8/R	200	8	5	017180139
1718D10/R	250	10	5	017180149

1718A...R

lime tonde a taglio **mezzodolce**, senza impugnatura

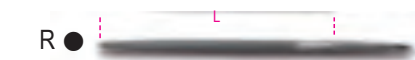

	L mm	L "		
1718A6/R	150	6	5	017180029
1718A8/R	200	8	5	017180039
1718A10/R	250	10	5	017180049

1718D...S5

serie di 5 lime a taglio **grossolano**, senza impugnatura

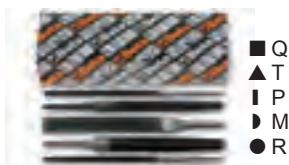

	L mm	L "		
1718D6/S5	150	6	1	017180130
1718D8/S5	200	8	1	017180140
1718D10/S5	250	10	1	017180150

1718A...S5

serie di 5 lime a taglio **mezzodolce**, senza impugnatura

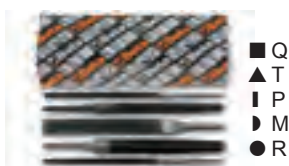

	L mm	L "		
1718A6/S5	150	6	1	017180030
1718A8/S5	200	8	1	017180040
1718A10/S5	250	10	1	017180050

1719BMD...Q

lime quadre a taglio **grossolano**, con impugnatura



	L mm	L "		
1719BMD6/Q	150	6	5	017190191
1719BMD8/Q	200	8	5	017190221
1719BMD10/Q	250	10	5	017190241
1719BMD12/Q	300	12	3	017190325

1719BMA...Q

lime quadre a taglio **mezzodolce**, con impugnatura



	L mm	L "		
1719BMA6/Q	150	6	5	017190021
1719BMA8/Q	200	8	5	017190052
1719BMA10/Q	250	10	5	017190071
1719BMA12/Q	300	12	3	017190311

1719BMX...Q

lime quadre a taglio **dolce**, con impugnatura



	L mm	L "		
1719BMX6/Q	150	6	5	017190022
1719BMX8/Q	200	8	5	017190053
1719BMX10/Q	250	10	5	017190072

1719BMD...T

lime triangolari a taglio **grossolano**, con impugnatura

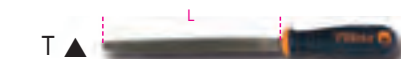

	L mm	L "		
1719BMD6/T	150	6	5	017190193
1719BMD8/T	200	8	5	017190223
1719BMD10/T	250	10	5	017190243
1719BMD12/T	300	12	3	017190326

1719BMA...T

lime triangolari a taglio **mezzodolce**, con impugnatura

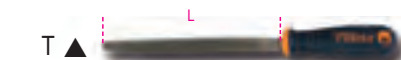

	L mm	L "		
1719BMA6/T	150	6	5	017190023
1719BMA8/T	200	8	5	017190054
1719BMA10/T	250	10	5	017190073
1719BMA12/T	300	12	3	017190313

1719BMX...T

lime triangolari a taglio **dolce**, con impugnatura

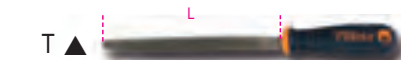

	L mm	L "		
1719BMX6/T	150	6	5	017190024
1719BMX8/T	200	8	5	017190055
1719BMX10/T	250	10	5	017190074

1719BMD...P

lime piatte a taglio **grossolano**, con impugnatura



	L mm	L "		
1719BMD6/P	150	6	5	017190195
1719BMD8/P	200	8	5	017190225
1719BMD10/P	250	10	5	017190245
1719BMD12/P	300	12	3	017190327

1719BMA...P

lime piatte a taglio **mezzodolce**, con impugnatura



	L mm	L "		
1719BMA6/P	150	6	5	017190025
1719BMA8/P	200	8	5	017190056
1719BMA10/P	250	10	5	017190075
1719BMA12/P	300	12	3	017190315

1719BMX...P

lime piatte a taglio **dolce**, con impugnatura

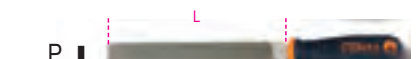

	L mm	L "		
1719BMX6/P	150	6	5	017190026
1719BMX8/P	200	8	5	017190057
1719BMX10/P	250	10	5	017190076

1719BMD...M

lime mezzotonde a taglio **grossolano**, con impugnatura

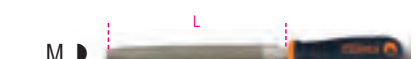

	L mm	L "		
1719BMD6/M	150	6	5	017190197
1719BMD8/M	200	8	5	017190227
1719BMD10/M	250	10	5	017190247
1719BMD12/M	300	12	3	017190328

1719BMA...M

lime mezzotonde a taglio **mezzodolce**, con impugnatura

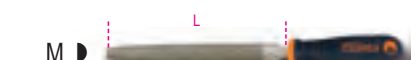

	L mm	L "		
1719BMA6/M	150	6	5	017190027
1719BMA8/M	200	8	5	017190058
1719BMA10/M	250	10	5	017190077
1719BMA12/M	300	12	3	017190317

1719BMX...M

lime mezzotonde a taglio **dolce**, con impugnatura



	L mm	L "		
1719BMX6/M	150	6	5	017190028
1719BMX8/M	200	8	5	017190059
1719BMX10/M	250	10	5	017190078

1719BMD...R

lime tonde a taglio **grossolano**, con impugnatura

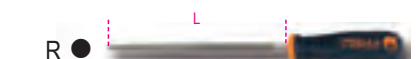

	L mm	L "		
1719BMD6/R	150	6	5	017190199
1719BMD8/R	200	8	5	017190229
1719BMD10/R	250	10	5	017190249
1719BMD12/R	300	12	3	017190329

1719BMA...R

lime tonde a taglio **mezzdolce**, con impugnatura



	L mm	L "		
1719BMA6/R	150	6	5	017190029
1719BMA8/R	200	8	5	017190060
1719BMA10/R	250	10	5	017190079
1719BMA12/R	300	12	3	017190319

1719BMX...R

lime tonde a taglio **dolce**, con impugnatura



	L mm	L "		
1719BMX6/R	150	6	5	017190031
1719BMX8/R	200	8	5	017190061
1719BMX12/R	250	10	5	017190081

1719BMD...S5

serie di 5 lime a taglio **grossolano**, con impugnatura



	L mm	L "		
1719BMD6/S5	150	6	1	017190200
1719BMD8/S5	200	8	1	017190230
1719BMD10/S5	250	10	1	017190250
1719BMD12/S5	300	12	1	017190363

1719BMA...S5

serie di 5 lime a taglio **mezzdolce**, con impugnatura



	L mm	L "		
1719BMA6/S5	150	6	1	017190030
1719BMA8/S5	200	8	1	017190070
1719BMA10/S5	250	10	1	017190080
1719BMA12/S5	300	12	1	017190361

1719BMX...S5

serie di 5 lime a taglio **dolce**, con impugnatura



	L mm	L "		
1719BMX6/S5	150	6	1	017190032
1719BMX8/S5	200	8	1	017190069
1719BMX10/S5	250	10	1	017190082

1719BMB/P

lime piatte a taglio universale
impugnatura in materiale plastico



	L mm	L "		
1719BMB/P250	250	10	5	017190152
1719BMB/P300	300	12	5	017190153

1719BMC

lime mezzotonde e piatte a mazzo
impugnatura in materiale plastico



UNI 5569 - UNI 5568

	L mm	L "		
1719BMC/M250	250	10	6	017190252
1719BMC/M300	300	12	4	017190253
1719BMC/P250	250	10	6	017190262
1719BMC/P300	300	12	4	017190263

1719BM/RR

raspa tonda
impugnatura in materiale plastico



	L mm	L "		
1719BM/RR	200	8	5	017190351

1719BM/RL

raspa piatta
impugnatura in materiale plastico



	L mm	L "		
1719BM/RL	200	8	5	017190360

1719BMR

impugnature per lime



	L mm	A mm		
1719BMR/0	95	25	10	017190950
1719BMR/0B	110	29	10	017190955
1719BMR/1	110	29	10	017190951
1719BMR/1B	110	29	10	017190953
1719BMR/2	123	31	10	017190952
1719 BMR/2B	123	31	10	017190954

	mm	"		
1719BMR/0	100/150	4/6	▲ D	
1719BMR/0B	100/150	4/6	■●	
1719BMR/1	150/200	6/8	▲ D	
1719BMR/1B	150/200	6/8	■●	
1719BMR/2	250/300	10/12	▲ D	
1719 BMR/2B	250/300	10/12	■●	

1720/...

lime ad ago



UNI 5569 UNI 5670

	L mm		
1720T	160	5	017200004
1720P	160	5	017200006
1720M	160	5	017200008
1720Q	160	5	017200009
1720R	160	5	017200010
1720C	160	5	017200012
1720B	160	5	017200005
1720ML	160	5	017200007
1720BT	160	5	017200011
1720F	160	5	017200013
1720PP	160	5	017200014
1720RM	160	5	017200015



1720/S3	1	017200000
---------	---	-----------

1720/B



1720/B6	1	017200002
1720/B12	1	017200003

1720D/...

lime ad ago diamantate

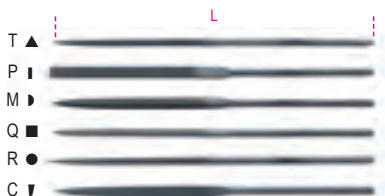

	L mm	
1720D/T	160	2 017200104
1720D/P	160	2 017200106
1720D/M	160	2 017200108
1720D/Q	160	2 017200109
1720D/R	160	2 017200110
1720D/C	160	2 017200112



1720D/B6 1 017200120

1721/B6

serie di 6 lime per contatti
in busta di plastica



1721/B6 1 017210010

1723

tenditore per molle



1723 210 5 017230001

1725

seghetto



1725 420 300 4 017250001

1725CR

miniseghetto



1725CR 250 150 5 017250010

1726

seghetto
con sistema di tensionamento della lama
incorporato nell'impugnatura

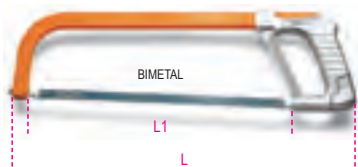

1726 440 300 4 017260001

1726BM

seghetto con sistema di tensionamento
della lama a sgancio rapido

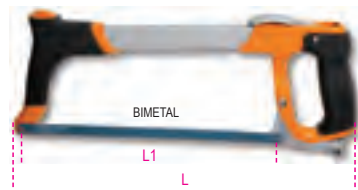

1726BM 400 300 1 017260050

1727

seghetto tipo pesante

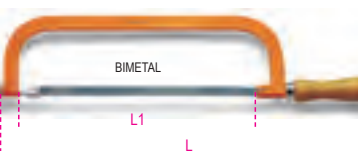

1727 515 300 4 017270001

1727BM

seghetto
portalama



1727BM 315 300 5 017270020

1728...

lame per seghetti



1728LA	100 017280001
1725CR	
1725MQ	
1728BM	100 017280010
1725-1726	
1727-1727M	
1728CO	50 017280030
1725-1726	
1727-1727M	

1729

segoncino ad arco



1729 710 610 5 017290001

1729LR

lama per segoncino 1729

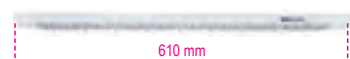

1729LR 10 017290010

1729CG

seghetto per cartongesso



1729CG 310 160 2 017290200

1729DM 450

segaccio per legno

dentatura media, 12 denti per pollice



1729DM 450 400 4 017290450

1736A

spazzola per lime



1736A 240 10 017360010

1737

spazzolino con fili di ottone



1737 145 10 017370001

1737NX

spazzola curva a fili di acciaio



L
mm
1737NX 270 5 017370010

1737AC

spazzola a fili di acciaio



L
mm
1737AC 275 5 017370020

1737B

coppie di spazzole per pulizia morsetti e poli batteria veicoli



1737B 1 017370050

1738

pennello



L mm H mm
1738 210 30 10 017380001

1739B

rivettatrice estensibile fornita con 5 testine intercambiabili



max 830 mm
Ø mm 3,2 4 4,8 5 6 6,4
Alluminio • • • • •
Inox • • • •

1739B 1 017390151

1740A

rivettatrice di potenza fornita con 5 testine intercambiabili



525 mm
Ø mm 3,2 4 4,8 5 6 6,4
Alluminio • • • • •
Inox • • • •

1740A 1 017400101

1740B

rivettatrice di potenza compatta con serbatoio porta-steli fornita con 5 testine intercambiabili



Ø mm 2,4 3 3,2 4 4,8
Alluminio • • • • •
Acciaio • • • • •
Inox • • • • •

L mm
1740 B280 280 1 017400280

Ø mm 3,2 4 4,8 5 6 6,4
Alluminio • • • • •
Acciaio • • • • •
Inox • • • • •

L mm
1740 B330 330 1 017400330

1741B

rivettatrice fornita con 4 testine intercambiabili



250 mm
Ø mm 2,4 3,2 4 4,8 5
Alluminio • • • • •
Acciaio • • • • •
Inox • • •

1741B 1 017410000

1741B/C5

rivettatrice 1741B con assortimento di 700 rivetti in alluminio



1741B/C5 1 017410025

	Ø mm	L mm	n.
1741RV2,9K	3,0	6	200
1741RV3,2K	3,2	8	200
1741RV3,8K	4,0	10	100
1741RV4K	4,0	12	100
1741RV4,8K	4,8	12	100

415x155x60 mm - 3,1 Kg

1741BP

rivettatrice fornita con 4 testine intercambiabili



260 mm
Ø mm 2,4 3,2 4 4,8 5
Alluminio • • • • •
Acciaio • • • • •
Inox • • • • •

1741BP 1 017410350

1741U

rivettatrice ultra compatta con regolazione dello sforzo fornita con 4 testine intercambiabili



200 mm
Ø mm 2,4 3 3,2 4 4,8
Alluminio • • • • •
Acciaio • • • • •
Inox • • • •

1741U 1 017410450

1741RV...K

rivetti in alluminio

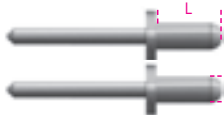

1741RV2,9K	1 017410191
ØxL = 3x6 mm	
1741RV3,2K	1 017410192
ØxL = 3,2x8 mm	
1741RV3,8K	1 017410193
ØxL = 4x10 mm	
1741RV4K	1 017410194
ØxL = 4x12 mm	
1741RV4,8K	1 017410195
ØxL = 4,8x12 mm	

I prezzi indicati sono relativi a 500 pezzi

1742

rivettatrice per inserti filettati
fornita con 4 testine intercambiabili
e 4 perni (1x M3;M4;M5;M6)



1742 1 017420001

M	Ø mm	L mm
3	5	11
4	6	11
5	7	13
6	9	17

1742KR

kit di 4 perni di ricambio per 1742



M3	1 017420043
M4	1 017420044
M5	1 017420045
M6	1 017420046

1742R-AL/M...

rivetti in alluminio filettati per
1742-1742A-1946KF



1742R-AL/M3	1 017420023
ØxL = 5x10 mm	
M = 3	
1742R-AL/M4	1 017420024
ØxL = 6x12 mm	
M = 4	
1742R-AL/M5	1 017420025
ØxL = 7x13 mm	
M = 5	
1742R-AL/M6	1 017420026
ØxL = 9x15 mm	
M = 6	

I prezzi indicati sono relativi a 20 pezzi

1742R-A/M...

rivetti in acciaio filettati per
1742-1742A-1946KF



1742R-A/M3	1 017420013
ØxL = 5x11 mm	
M = 3	
1742R-A/M4	1 017420014
ØxL = 6x11 mm	
M = 4	
1742R-A/M5	1 017420015
ØxL = 7x13 mm	
M = 5	
1742R-A/M6	1 017420016
ØxL = 9x17 mm	
M = 6	
• 1742R-A/M8	1 017420018
ØxL = 11x17 mm	
M = 8	
• 1742R-A/M10	1 017420020
ØxL = 13x24 mm	
M = 10	

I prezzi indicati sono relativi a 20 pezzi
• I prezzi indicati sono relativi a 10 pezzi

1742/C4

rivettatrice 1742 con assortimento
di 400 inserti filettati in acciaio



1742/C4 1 017420005

	Ø		n.
	M	mm	
1742R-A/M3	3	5	100
1742R-A/M4	4	6	100
1742R-A/M5	5	7	100
1742R-A/M6	6	9	100

415x155x60 mm - 2,9 kg

1742A

rivettatrice di potenza per inserti filettati
fornita con 4 testine intercambiabili



1742A 1 017420100

M	Ø mm	L mm
5	7	13
6	9	17
8	11	17
10	13	24

1742A/KR

kit di 4 perni di ricambio per 1742A

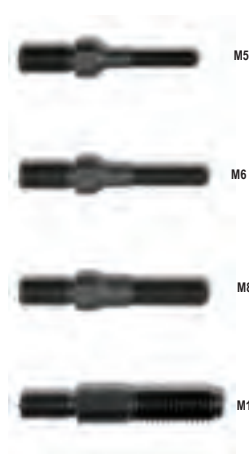

1742A/KR	M5	1 017420143
1742A/KR	M6	1 017420144
1742A/KR	M8	1 017420145
1742A/KR	M10	1 017420146

1742A/C

rivettatrice 1742A con assortimento
di 60 inserti filettati in acciaio



1742A/C 1 017420105

	Ø		n.
	M	mm	
1742R-A/M5	5	7	20
1742R-A/M6	6	9	20
1742R-A/M8	8	11	10
1742R-A/M10	10	13	10

536x310x80 mm - 2,1 kg

1743

pinza per fascette in Nylon

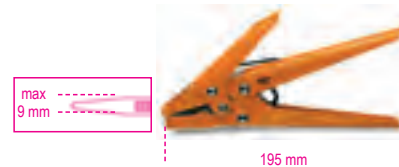

1743 1 017430001

1743T

pinza tagliafascette

• Adatta anche per il taglio di piccoli cavi
(3x1.5mm²; 1x17mm²)



1743T 1 017430100

1748/...K

fascette in Nylon
a testa autobloccante nere

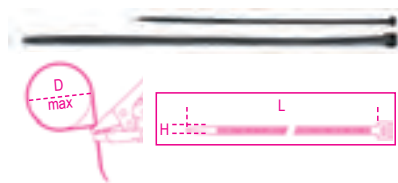

Model	QTY	Part No.
1748/3K	1	017480203
HxL = 2,5x100 mm D = 18 mm		
1748/6K	1	017480206
HxL = 2,5x160 mm D = 40 mm		
1748/7K	1	017480207
HxL = 3,6x150 mm D = 33 mm		
1748/8K	1	017480208
HxL = 3,6x200 mm D = 46 mm		
1748/9K	1	017480209
HxL = 3,6x300 mm D = 70 mm		
1748/14K	1	017480214
HxL = 4,8x190 mm D = 43 mm		
1748/17K	1	017480217
HxL = 4,8x300 mm D = 72 mm		
1748/18K	1	017480218
HxL = 4,8x360 mm D = 85 mm		
1748/23K	1	017480223
HxL = 7,6x300 mm D = 67 mm		
1748/24K	1	017480224
HxL = 7,6x368 mm D = 88 mm		

I prezzi indicati sono relativi a 100 pezzi

1748B/...K

fascette in Nylon, a testa autobloccante
bianche

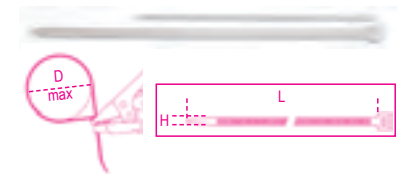

Model	QTY	Part No.
1748B/3K	1	017480303
HxL = 2,5x100 mm D = 18 mm		
1748B/6K	1	017480306
HxL = 2,5x160 mm D = 40 mm		
1748B/7K	1	017480307
HxL = 3,6x150 mm D = 38 mm		
1748B/8K	1	017480308
HxL = 3,6x200 mm D = 46 mm		
1748B/9K	1	017480309
HxL = 3,6x300 mm D = 70 mm		
1748B/14K	1	017480314
HxL = 4,8x190 mm D = 44 mm		
1748B/17K	1	017480317
HxL = 4,8x300 mm D = 72 mm		
1748B/18K	1	017480318
HxL = 4,8x360 mm D = 86 mm		

I prezzi indicati sono relativi a 100 pezzi

1749

pistola per sigillante



Model	L min mm	QTY	Part No.
1749	340	2	017490001

1749A

pistola per sigillante
modello professionale
tubo in alluminio.
anche per sacchetti



Model	L min mm	QTY	Part No.
1749A	360	1	017490010

1749A/RB

beccucci di ricambio per 1749A

Model	QTY	Part No.
1749 A/RB	2	017490051

1749A/RT

tappi frontali avvitabili per 1749A

Model	QTY	Part No.
1749A/RT	1	017490052

1749AC

pistola ad alta spinta per ancoranti chimici
e cartucce standard



Model	L min mm	QTY	Part No.
1749AC	360	1	017490005



1750

compressori a leva per grasso



cc	L mm	QTY	Part No.
500	380	1	017500500
750	450	1	017500750

1750R/1 - 1750R/2

tubi flessibili di ricambio
in Nylon



Model	L mm	QTY	Part No.
1750R/1	310	2	017500030
1750R/2	410	2	017500040

1750RC

tubo rigido piegato



Model	L mm	M mm	QTY	Part No.
1750RC	150	10x1	2	017500050

1750RT

testina a 4 griffe
tipo "Hydraulic"



Model	M mm	QTY	Part No.
1750RT	10x1	5	017500110

1750RP/1 - 1750RP/2

testine per raccordi piatti

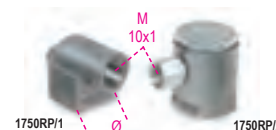

Model	Ø mm	M mm	QTY	Part No.
1750RP/1	16	10x1	2	017500115
1750RP/2	22	10x1	2	017500120

1750CG

cartucce di grasso per 1750



cc	QTY	Part No.
400	18	017500140
600	18	017500160

1750M

mini ingrassatore

- Con microugello
- Particolarmente indicato per utensili pneumatici



cc	D mm	L mm		
1750M	100	43	145	1 017500025

1751

oliatori metallici a pressione
cannuccia flessibile



cc	D mm	L mm		
200	62	140	4	017510002
300	75	140	4	017510003
500	85	140	4	017510005
750	100	140	2	017510007
1000	100	140	2	017510011

1751R

cannuccia di ricambio
per 1751



200÷1000	5	017510010
----------	---	-----------

1752

oliatori in plastica a pressione
cannuccia rigida



cc	D mm	L mm		
200	67	140	4	017520002
300	77	140	4	017520003
500	95	140	4	017520005
700	95	140	2	017520007

1752R

cannuccia di ricambio
per 1752



200÷700	5	017520020
---------	---	-----------

1753

oliatori in plastica a pressione
cannuccia flessibile



cc	D mm	L mm		
200	65	190	4	017530002
300	80	190	4	017530003
500	95	190	4	017530005
700	95	190	2	017530007

1753R

cannuccia di ricambio
per 1753



200÷700	5	017530020
---------	---	-----------

1754

oliatori in plastica a pressione
cannuccia flessibile



cc	D mm	L mm		
150	60	130	5	017540015
250	65	130	5	017540025

1755

oliatori in plastica
cannuccia rientrante



cc	L mm	A mm		
30	160	30	5	017550003
80	170	47	5	017550008
150	230	58	5	017550015

1756

oliatore a stilo



cc	L mm		
5	140	2	017560001

1756B

siringa per olio



cc	L mm		
500	280	2	017560220

1756C

siringa per olio da 200 ml
in polipropilene

- Adatta anche al liquido impianto freni
- Doppia guarnizione in EPDM
- Temperatura di funzionamento: +0 - +50°C
- Non adatta per carburanti e oli minerali



1756C	1	017560502
-------	---	-----------

1756D

siringa per olio da 1500 ml
in polipropilene

- Doppia guarnizione in NBR
- Temperatura di funzionamento: +0 - +50°C
- Non adatta per carburanti

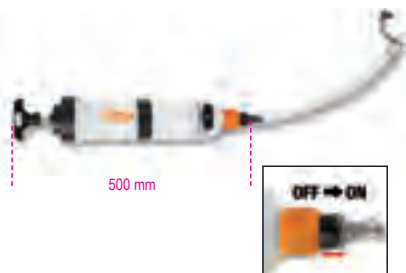

1756D	1	017560515
-------	---	-----------

1756C-2OR

coppia di O-ring per siringhe 1756C

1756C-2OR	1	017560503
-----------	---	-----------

1756D-2OR

coppia di O-ring per siringhe 1756D

1756D-2OR	1	017560516
-----------	---	-----------

1757

rabbocicatori per liquidi batterie



cc	D mm		
250	60	4	017570002
500	75	4	017570004
1000	90	2	017570006

1757A

colmatore per liquidi batterie



cc			
2000		1	017570020

1758A

imbuto antiriflusso
con attacco rapido Ø 38 mm
Particolarmente indicato per vetture
del gruppo Volkswagen



1758A		1	017580010
-------	--	---	-----------

1758LG

lamina modellabile in alluminio rivestita in
gomma, per la canalizzazione dei liquidi



L mm	H mm		
365	168	1	017580006

1758M

imbuto



	L mm		
1758 M	350	1	017580000

1758R

recipienti per liquidi

pratico beccuccio flessibile removibile



	lt		
1758R/3	3	1	017580203
1758R/5	5	1	017580205

1758VT

kit per la verifica delle testate

segnala rapidamente se nella vaschetta d'espansione è
presente anidride carbonica.



1758VT		1	017580100
--------	--	---	-----------

290x190x50 mm - 1kg

1758VT/L

liquido di contrasto per verifica testate



1758VT/L		1	017580101
----------	--	---	-----------

1759

analizzatore ottico per liquidi di
raffreddamento, batteria, lavavetri e AdBlue®
in astuccio rigido

Compensazione automatica della temperatura

Acido batteria: intervallo di misura
da 1,1 a 1,3 kg/l

Liquido di raffreddamento propilene:
da -25°C a -50°C

Liquido di raffreddamento etilene: da -25°C a -50°C

Liquido lavavetri: da -10°C a -40°C

AdBlue(R): Misurazione percentuale di urea da 30% a 35%



1759		1	017590251
------	--	---	-----------

1759A

densimetro per liquido anticongelante



	L mm		
1759A	340	1	017590001

1759B

densimetro per liquidi batteria



	L mm		
1759B	280	1	017590005

1759HD/3

strumenti per controllo tenuta impianto di raffreddamento e riempimento circuito

Permette di verificare sotto pressione le perdite del circuito (tubi, giunti, pompe, radiatori) e riempire velocemente il circuito evitando la formazione di bolle d'aria



1759HD/3

600x500x140 mm - 6,5 kg

1759HD/RR

strumento per riempimento impianto di raffreddamento



1759HD/RR

450x310x110 mm - 2,2 kg

1759HD/TRUCK

strumento per controllo e tenuta impianto di raffreddamento Truck



1759 HD/TRUCK

440x330x100 mm - 3 kg

1759TT

kit 4 coppie tappi verifica circuito turbo utilizzabile con pistole gonfiagomme



1759 TT

400x160x100 mm - 1,8 kg

1760DGT

multimetro digitale automotive



195 mm

92 mm

DATI TECNICI

RPM (tachimetro):

Per motori a 2 e 4 cilindri
RPM4 600 - 4000 RPM
RPM4 600 - 12000 RPM (x10 RPM)
RPM2/DIS 300 - 4000 RPM
RPM2/DIS 300 - 6000 RPM (x10 RPM)
Angolo Dwell: 4-8 CYL

Tensione DC: 400mV-4/40/400/1000V
Tensione AC: 4/40/400/700V
Corrente DC: 40/400mA-4/20A
Corrente AC: 40/400mA-4/20A
Resistenza: 400Ω-4/40/400kΩ-4/40MΩ
Capacità: 40/400nF-4/40/100μF
Frequenza: 5/50/500Hz-50/500-10MHz
Duty Cycle: 0.1 - 99,9%

Ampiezza pulsazioni: 1 - 10ms
Prova diodi: Corrente test 0,3mA
Continuità: <150Ω - Corrente test <0,3mA
Display: LCD ad alto contrasto 4 digit retro-illuminato
Sovratensione: Categoria II 1000V
Autospegnimento: 30 minuti
Alimentazione: 1 batteria 9V (inclusa)
Pinza induttiva (inclusa)
2 Puntali (inclusi)
Custodia morbida in tela (inclusa)
Manuale d'uso

1760DGT

440x330x100 mm - 3 kg

1760B

multimetro digitale



CE



PARAMETRI RILEVABILI

Tensione DC: 200 mV-2/20/200/1000V
Tensione AC: 2-20/200/700V
Corrente DC: 2/20/200 mA-20 A
Corrente AC: 2/200 mA- 20 A
Resistenza: 200Ω - 2/20/200 kΩ - 2/20 MΩ
Capacità: 2/20/200 nF - 2/200 μF
Temperatura: -20° + 1000°C/ -4 °F ~ +2000°F
Frequenza: 20kHz
Alimentazione: 1 batteria da 9V (inclusa)

1760B

440x330x100 mm - 3 kg

1760/OHM

multimetro/megaohmetro per test isolamento ad alta tensione.

con lettura a valore efficace TRUE RMS



CE

CAT. IV
600V
CAT. III
1000V



	Campo di misura	Precisione base
Tensione AC/DC:	50mV - 1000V	±0.06% - ±0.1% rdg
Corrente AC/DC:	0.01μA - 10A	±0.5% - ±1% rdg
Resistenza :	0.01Ω - 50MΩ	±0.2% - ±2% rdg
Meg OHM:	0.01 - 5000MΩ	±4% rdg. max current
1mA		
Capacità:	5nF - 10mF	±1.5% - ±3% rdg
Frequenza:	50Hz - 100 MHz	±0.02% - ±0.1% rdg
Temperatura:	-50°C - +1350°C	±0.5% rdg
Test diodi:	3V dc	
Test continuità:	<30 Ω	

1760/OHM

440x330x100 mm - 3 kg

1760/RMS

multimetro industriale IP67

con lettura a valore efficace TRUE RMS



CE

Campo di misura Precisione base
Tensione AC/DC 110mV - 600V $\pm 0.8\%$ - $\pm 2\%$ rdg
Corrente AC/DC 110 μ A - 10A $\pm 1.5\%$ - $\pm 2\%$ rdg
Resistenza 110 Ω - 40M Ω $\pm 1.2\%$ - $\pm 2.5\%$ rdg
Capacità 11nF - 40mF $\pm 5\%$ - $\pm 10\%$ rdg (fino a 11mF)
Frequenza 1100Hz - 110 MHz $\pm 1.2\%$ - $\pm 1.5\%$ rdg
Temperatura -32°C - +1000°C $\pm 3\%$ - $\pm 5\%$ rdg
Test diodi 3V dc $\pm 10\%$ rdg
Test continuità <30 Ω

1760/RMS 1 017600020

1760PA/80

pinza amperometrica AC/DC 80A

per misurazione di bassi valori di dispersione della corrente o assorbimenti sui veicoli



CE

- range: 1mA-80A AC/DC
- funzione torcia con LED bianco
- display LCD retroilluminato
- funzione azzeramento
- funzione Hold
- autospegnimento
- alimentazione: 2 batterie 1,5V tipo AAA

1760PA/80 1 017600002

Beta

1760PA/AC

pinza amperometrica e multimetro digitale

A: AC
V: AC/DC



CE



PARAMETRI RILEVABILI
Tensione DC: 400 mV - 4/40/400/600 V
Tensione AC: 400 mV - 4/40/400/600 V
Corrente AC: 40/400/1000 A
Resistenza: 400 Ω - 4/40/400 k Ω - 4/40 M Ω
Frequenza: 5/50/500 Hz - 5/50/500 kHz - 5/10 MHz
Capacità: 40/400 nF - 4/40/100 μ F
Temperatura: -20°C \pm 1000°C / - 4 °F \pm 1832 °F
Alimentazione: 1 batteria da 9V (inclusa)

1760PA/AC 190 mm 1 017600050

1760PA/AC-DC

pinza amperometrica e multimetro digitale

A: AC/DC
V: AC/DC



CE



PARAMETRI RILEVABILI
Tensione DC: 0.1mV \pm 600V
Tensione AC: 0.1mV \pm 600V
Corrente AC: 0.01A \pm 1000A
Corrente DC: 0.01A \pm 1000A
Resistenza: 0.1 Ω \pm 40M Ω
Capacità: 0.001nF \pm 40 μ F
Frequenza: 0.001kHz \pm 4kHz
Temperatura: -40°C \pm 1000 °C -40°F \pm 1832°F
Alimentazione: 1 batteria da 9V (inclusa)

1760PA/AC-DC 1 017600000

1760/TC2

tachimetro digitale a distanza e a contatto



DATI TECNICI
• Per misurazione di:
- rotazione a distanza (g/min - rpm)
- rotazione (g/min - rpm) e velocità lineare (m/min o ft/min) a contatto.
• Display LCD a 5 cifre.
• Scala:
- a distanza 2,5+99.999 g/min
- a contatto 0,5+19.999 g/min
- velocità lineare 0,05+1.999,9 m/min.
• Frequenza: 0,8 sec.
• Alimentazione: 4 batterie 1,5V (AA) (incluse) o alimentatore 6V (non incluso)
• Fornito con:
- adattatore per misurazioni a contatto
- 2 puntali maschio in gomma
- 1 puntale femmina in gomma
- 1 rotella per rilevazioni lineari
- etichette riflettenti
- manuale di istruzioni
- custodia in plastica.

1760/TC2 230 mm 74 mm 1 017600161

1760R/TC2

etichette riflettenti per 1760/TC2



1760R/TC2 1 017600561

Beta

1760/IR800

termometro digitale ad infrarossi
con doppio puntamento laser



CE

DATI TECNICI

Gamma: da -50°C a 800°C / da -58°F a 1472°F
Selezione scala: °C/°F
Precisione: ±1,0% o ±1,0°C a 20°C
Potenza Laser: <1mW
Risposta: 150ms
Emissività: 0,10-1,0 regolabile
Rapporto distanza: (D:S) 20:1
Temperatura operativa: 0°C ± 50°C / 32°F ± 122°F
Umidità operativa: da 10% a 90% RH
Display LCD retro-illuminato
Funzione di mantenimento dei dati
Auto spegnimento
Alimentazione: 1 batteria 9V (inclusa)
Custodia morbida in tela (inclusa)
Manuale d'uso

1760/IR800

1 017600380

1760/IR1600

termometro digitale ad infrarossi
con puntamento laser



CE

DATI TECNICI

Gamma: da -50°C a 1600°C / da -58°F a 2912°F
Selezione scala: °C/°F
Precisione: ±1,5% o ±2°C a 20°C
Potenza Laser: <1mW
Risposta: 1sec
Emissività: 0,10-1,0 regolabile
Rapporto distanza: (D:S) 50:1
Temperatura operativa: 0°C ± 50°C / 32°F ± 122°F
Umidità operativa: da 10% a 90% RH
Display LCD retro-illuminato
Funzione di mantenimento dei dati
Auto spegnimento
Alimentazione: 1 batteria 9V (inclusa)
Custodia rigida e treppiede in alluminio
Manuale d'uso

1760/IR1600

1 017600460

1761

pinza torcifilo
a ritorno automatico



L
mm
255

1 017610101

1761RS/1

pinza torcifilo reversibile
a ritorno automatico



L
mm
220

1 017610130

1762

pinza fustellatrice



Ø
mm
2-2,5-3
3,5-4-4,5

L
mm
210

2 017620001

1765/C24

cassetta di 24 attrezzi
per estrazione autoradio



1765/C24

1 017650001

1766

ventosa doppia



max
kg
50

2 017660001

1766A

ventosa singola



max
kg
30

2 017660005

1766/8

assortimento di 8 utensili
per cristalli auto



1766/8

1 017660100

1766ER

estrattore per raschiavetri
con impugnatura
permette di rimuovere agevolmente
i raschiavetri senza rischi di danneggiamenti



1766ER

1 017660501

1766L

leva per cristalli



1766L

1 017660015

1766LI

leva per inserimento cavo tagliacrystalli

bordi affilati per taglio sigillante



1766LI 1 017660016

1766I

impugnatura per cavo d'acciaio 1766G

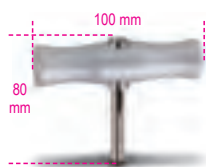

1766I 2 017660020

1766G

cavo d'acciaio per cristalli

sezione quadrata



50 m 1 017660025

1766T

cavo d'acciaio per cristalli

sezione triangolare



50 m 1 017660026

1767PMC

portaminuterie magnetico tondo



1767PMC 1 017670020

1767PMR

portaminuterie magnetico rettangolare



1767PMR 1 017670010

1770

cutter extra piatto
fornito con 2 lame



1770 L mm 140 A mm 9 10 017700001

1770A

cutter 9mm con blocco automatico della lama,
fornito con 3 lame

• cursore di sicurezza antiritorno



1770A L mm 135 A mm 9 10 017700025

1770RL

10 lame a settori 9 mm
per cutter 1770 e 1770A



1770RL 5 017700010

1770BM

cutter 9 mm,
fornito con 6 lame

caricamento automatico della lama



1770BM L mm 140 A mm 9 10 017700050

1771

cutter 18 mm
fornito con 3 lame



1771 10 017710000

1771BM

cutter 18 mm
fornito con 6 lame
caricamento automatico della lama



1771BM L mm 170 A mm 18 10 017710050

1771RL

10 lame a settori 18 mm
per cutter 1771 e 1771BM



1771RL 5 017710010

1772R

cutter a lama trapezoidale retrattile,
fornito con 5 lame
caricamento automatico della lama



1772R L mm 125 A mm 18 5 017720006

1772H

cutter a lama retrattile di sicurezza,
fornito con 2 lame



1772H L mm 170 A mm 18 5 017720029

1772RL/2

10 lame trapezoidali lunghe, in astuccio,
per cutter 1772R, 1772H, 1774, 1777BMT, 1777T



1772RL/2 5 017720017

1773A

cutter 25 mm

- sistema bloccalama a ghiera
- lama da 25 mm



1773A	L mm	A mm	10	017730000
	180	25		

1773RL

10 lame a settori 25 mm per cutter 1773A



1773RL	5	017730015
--------	---	-----------

1774

raschietto multiuso con salvalama di protezione



1774	L mm	L1 mm	5	017740001
	165	60		

1774A

raschietto multiuso con impugnatura bimateriale



1774A	L mm	L1 mm	1	017740011
	300	40		

1774A/RL

10 lame per raschietto 1774A

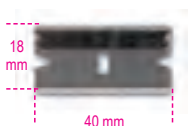

1774A/RL	1	017740511
----------	---	-----------

1777BM

coltello a serramanico con gola spellafili lama in acciaio inossidabile



1777BM	L mm	L1 mm	A mm	5	017770100
	190	80	16		

1777T

cutter a serramanico con lama trapezoidale impugnatura in alluminio, fornito con 5 lame



1777T	L mm	A mm	L1 mm	5	017770030
	160	19	65		

1777BMT

cutter a serramanico con lama trapezoidale 4 profondità regolabili della lama 4; 9.5; 15.5; 21.5 mm fornito con 3 lame



1777BMT	L mm	L1 mm	A mm	5	017770050
	170	80	19		

1778

coltello a serramanico impugnatura in alluminio • in astuccio



1778	L mm	A mm	L1 mm	5	017780045
	195	24	80		

1778CM

coltello a serramanico mimetico lama in acciaio temprato • in astuccio



1778CM	L mm	A mm	L1 mm	5	017780099
	195	24	80		

1778D

coltello a serramanico lama ed impugnatura in acciaio inossidabile • in astuccio



1778D	L mm	A mm	L1 mm	5	017780060
	180	22	78		

1778SCL

coltello a serramanico con finitura soft carbon look lama in acciaio temprato • in astuccio



1778SCL	L mm	A mm	L1 mm	5	017780089
	180	22	78		

1778SAFE

coltello a serramanico lama in acciaio temprato con funzione martello frangicristallo, tagliacinture di sicurezza e punzone scioglinodi • in astuccio



1778SAFE	L mm	A mm	L1 mm	5	017780090
	210	25	85		

1778SOS

coltello soccorso auto con funzione martello frangicristallo e tagliacinture di sicurezza • in astuccio



1778SOS	L mm	A mm	L1 mm	5	017780080
	205	25	85		

1778W

coltello a serramanico
lama in acciaio inossidabile
impugnatura con inserti in legno
•in astuccio



	L	A	L1		
	mm	mm	mm		
1778W	180	22	78	5	017780025

1778X

coltelli per nautica in acciaio inossidabile
impugnatura in alluminio



	L	L1	A		
	mm	mm	mm		
1778X	185	85	25	2	017780050

1781

forbici a lame lunghe sottili



	L		
	mm		
1781	132	2	017810001

1783

forbici modello leggero



	L		
	mm		
215		5	017830021
240		5	017830024

1784

forbici modello pesante



L			
mm			
175	2	017840017	
200	2	017840020	
250	2	017840025	
300	2	017840030	

1800/100

cuscini sollevatori (max 135 kg)

- sollevare- livellare
- bloccare porte ed ante



A	B	S		
mm	mm	mm		
160	150	2÷55	3	018000000

1808

saldatore a doppia potenza
con punta acciata 1824 R08



W	V		
mm	mm		
20/130	230	1	018080001

1812 150

saldatore istantaneo



W	V		
mm	mm		
150	230	1	018120015

1814M

saldatori a stilo
con punta acciata



W	V		
mm	mm		
25	230	1	018140225
30	230	1	018140230
40	230	1	018140240

1820

saldatori a stilo



1820 30	30W	L = 210mm	1	018200003
1820 60	60W	L = 220mm	1	018200006
1820 80	80W	L = 260mm	1	018200008

1822

saldatori a martello



1822 120	120W	LxA = 250x125 mm	1	018220012
1822 180	180W	LxA = 250x125mm	1	018220018
1822 320	320W	LxA = 250x140mm	1	018220032

1823 60

stazione di saldatura
a controllo digitale
fornita con saldatore

- Regolazione continua della temperatura da 160°C a 480°C con precisione ±1%.
- Funzione di memoria per salvataggio temperatura selezionata al momento dello spegnimento.
- 3 tasti di selezione rapida (200-300-400°C).



W	V		
mm	mm		
60		1	018230060

1823R/60

saldatore di ricambio per 1823 60



1823 R/60 1 018230066

1824R

punte di ricambio per saldatori



1824R08 1808	1 018240100
1824R 1812/150	1 018240301
1824R14-M25 1814M/25	1 018240152
1824R14-M30 1814M/30	1 018240153
1824R14-M40 1814M/40	1 018240154
1824 R30 1820/30	1 018240302
1824 R60 1820/60	1 018240303
1824 R80 1820/80	1 018240304
1822 R120-180 1822/120 -/180	1 018240305
1824 R320 1822/320	1 018240307
1824 RST-60 1823-60	1 018240308

1825B

filo per saldatura a stagno con antiossidante

- filo da 1mm²; 250g
- Sn 99.3%; Cu 0.7%



1825B 1 018250251

1827

saldatore a gas regolabile

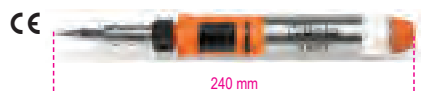

1827 1 018270001

1827PC

punte di ricambio coniche per 1827

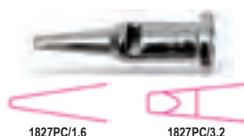

1827PC/1,6 1 018270501
1827PC/3,2 1 018270502

1827PCL

punta di ricambio a coltello per 1827



1827PCL/2,4 1 018270503

1827PFL

punte di ricambio a fiamma libera per 1827



1827PFL 1 018270504

1827/K

saldatore a gas con 7 accessori in valigetta con base morbida di polietilene espanso



- Potenza: da 30 Watt a 125 Watt.
- Temperatura della punta regolabile da 250°C a 500°C.
- Regolatore del flusso di gas.
- Tempo di riscaldamento: 15 secondi dopo l'accensione.
- Il serbatoio contiene gas per 120 minuti di utilizzo continuato.
- Serbatoio trasparente per monitorare il livello di gas.
- Ricaricabile con gas butano.

1827/K 1 018270100

1830T

pompetta per dissaldare con ugello antistatico in materiale plastico (PTFE)



1830T 5 018300021

1834L/USB

torcia LED ricaricabile ad alta luminosità in robusto alluminio anodizzato, fino a 450 Lumen ricarica con presa micro-USB



IPX6
L mm 220 1 018340075

1834RB-L/USB

batteria di ricambio per 1834L/USB

1834RB-L/USB 1 018340975

1834PS

torcia LED ad alta luminosità in robusto alluminio anodizzato, fino a 300 Lumen

- batterie (non include): 2xAA (durata 9/29 h)
- lumen: 300>100>OFF
- IPX6



L mm 150 1 018340310

1834PM

torcia LED ad alta luminosità in robusto alluminio anodizzato, fino a 350 Lumen

- batterie (non include) :
- 1xAAA (durata 11/33 h)
- 2xAAA (durata 13/39 h)
- 3xAAA (durata 15/45 h)
- lumen: 350>40>OFF
- indicatore di carica
- IPX6



L mm 140 1 018340320

1834PL

torcia LED ad alta luminosità in robusto alluminio anodizzato, fino a 500 Lumen

- batterie (non include) :
- 1xAA (durata 20/60 h)
- 2xAA (durata 28/84 h)
- 3xAA (durata 36/108 h)
- lumen: 500>40>OFF
- indicatore di carica

•IPX6



L mm 210 1 018340325

1834PXL

torcia LED ad alta luminosità
in robusto alluminio anodizzato,
fino a **1350 Lumen**

- batterie (non incluse) : 3xD (durata 40/120 h)
- lumen: 1350>450>OFF
- indicatore di carica
- IPX6



L
mm
315

1 018340330

1835/1

torcia LED per ispezioni,
in robusto alluminio anodizzato

- pile 1xAAA (non inclusa)
- IPX6



L
mm
105

3 018350030

1835/2

torcia LED per ispezioni,
in robusto alluminio anodizzato

- pile 2xAAA (non incluse)
- IPX6



L
mm
145

3 018350060

Beta

1836A

lampada da testa a LED, con doppia
luminosità e sensore ON/OFF contactless

- 120/65 lumen
- IP54
- pile : 3xAAA incluse



1836A

1 018360050

1836B

lampada da testa ricaricabile a LED,
con doppia luminosità e sensore ON/OFF

- Sensore ON/OFF contactless
- 160 Lumen
- Autonomia : 3-6 h
- IP65

CE



1836B

1 018360200

1837N

lampada magnetica snodata con LED ad alta
luminosità
fino a **400 Lumen**

- batterie (non incluse) :
 - 1xAA (durata 25/69 h)
 - 2xAA (durata 33/96 h)
 - 3xAA (durata 43/124 h)
- lumen: 400>40>OFF
- Indicatore di carica
- cono luminoso regolabile
- IPX6



L
mm
450

1 018370002

1837/USB

lampada **ricaricabile** magnetica snodata con
LED ad alta luminosità
caricatore non incluso

- doppia luminosità: 150/450 Lumen
- fuoco regolabile
- batteria ai polimeri di litio
- indicatore di carica (verde >85%; rosso <15%)
- durata 4-8 ore (dipendente dalla luminosità)
- ricarica con attacco Micro USB

IPX6



1837/USB

1 018370051

1837RB/USB

batteria di ricambio per 1837/USB

1837RB/USB

1 018370901

1837PLUS

faretto a LED da cantiere

- luminosità: 3000 lumen;
regolabile (10%; 25%; 50%; 75%; 100%)
- alimentazione: 100-240V AC - 50/60Hz; 26W
- protezione impatti: IK07
- cavo: 5m / 3x1mm²
- dimensioni: 235 x 83 x 233 mm

CE



1837PLUS

1 018370026

Beta

1838/11LED

lampada ricaricabile con LED ad altissima luminosità
batteria ai polimeri di litio

- corpo compatto in gomma antiscivolo
- vetrino frontale facilmente sostituibile
- gancio orientabile
- con stazione di ricarica 110-230Vac
- 320 Lumen
- con led in testa per illuminazione multidirezionale



1838/11LED 1 018380111

1838RA/10-11LED

alimentatori di ricambio per 1838/10LED e 1838/11LED

1838RA/10-11LED 1 018380903

1838RB/10LED

batteria di ricambio per 1838/10LED e 1838/11LED

1838 RB/10LED 1 018380902

1838RR/11LED

basi di ricarica per 1838/11LED

1838RR/11LED 1 018380914

1838RV/11LED

vetrino paragraffi di ricambio per lampada 1838/11LED



1838RV/11LED 2 018380905

1838COB

lampada a LED portatile ricaricabile

- appendibile, con corpo in gomma antiscivolo e antiurto
- batteria ai polimeri di Litio
- 55/110 lumen



IP20

1838COB 1 018380010

1838P

lampada ricaricabile a penna, con doppia emissione luminosa: a lampada o a torcia

- Corpo compatto in gomma antiscivolo
- 50/80 Lumen
- Gancio da taschino
- Base magnetica orientabile a 180 gradi
- Fornita con cavo di ricarica USB/microUSB
- Autonomia: 2.5 ore
- IP20



1838P 1 018380005

1838FLASH

faretto ricaricabile ultracompatto, studiato per offrire la migliore soluzione possibile in ogni utilizzo.

ILLUMINAZIONE ABBONDANTE E SEMPRE PRONTA: con una capacità illuminante massima di 720 lumen e la possibilità di lavorare a batteria o a cavo è sempre pronto all'uso

POSIZIONABILE OVUNQUE:

- su piani: grazie ai piedini di gomma e all'attacco da 1/4" per cavalletto (attacco standard tipo macchina fotografica)
- su strutture metalliche: grazie al magnete svitabile e al gancio orientabile a 360°

COMPATTO: con soli 85x100x155 mm di ingombro può essere comodamente alloggiato nella borsa degli attrezzi ed utilizzato anche in spazi ristretti.

ROBUSTO: studiato per resistere alle sollecitazioni meccaniche più severe.

- 720 Lumen



IP65

1838FLASH 1 018380300

1838RB/FLASH

batteria di ricambio per 1838FLASH

1838RB/FLASH 1 018380930

1838LED/120

lampada sottocofano orientabile a LED

- Cavo antiolio da 5m
- Striscia LED da 600 Lumen, 7.5W
- Apertura ganci: 120 ÷ 170 cm



IP65

1838LED/120 1 018380250

1838LED/120-AL

alimentatori con cavo di ricambio per 1838LED/120

1838LED/120-AL 1 018380251

1838SL

lampada ultrasottile con LED ad altissima luminosità.

Per lavori in spazi ristretti

- alimentazione 12V con spina accendisigari e morsetti per batteria
- cavo da 2,5 m
- spessore 6mm
- 345 Lumen

CE



1838SL

1 018380101

1838UV

lampada ricaricabile UV + luce bianca ideale per la ricerca di perdite

- Corpo compatto in gomma antiscivolo
- Con caricatore 100-240Vac / 50-60Hz
- 150 lumen / UV

CE



1838UV

1 018380150

1839/R1

trasformatore con uscita USB, ricambio per 1834L/USB; 1836B; 1837/USB; 1838COB; 1838P; 1838UV

IN: 100-240Vac / 50-60Hz
USB OUT: 5Vdc / 1A

1839/R1

1 018390501

1839/R2

cavo USB/jack 3.5mm, ricambio per 1836B; 1838P; 1838COB; 1838UV

1839/R2

1 018390502

1839/R3

cavo USB/MicroUSB, ricambio per 1834L; 1837/USB

1839/R3

1 018390503

1840BM

portalampada portatile per lampada con attacco E27 alimentazione 230V

- Lampada esclusa

CE

CE



IP20

1840BM

V 230 W 60 L mm 420

1 018400101

1842LED/BM

lampada con LED ad altissima luminosità, 100- 240 Vac

- cavo da 10 m
- corpo compatto in gomma antiscivolo
- vetrino frontale facilmente sostituibile
- gancio orientabile
- 340 Lumen
- con LED in testa per illuminazione multidirezionale



1842LED/BM

1 018420301

1842LED/ABM

lampada con LED ad altissima luminosità, 12-24 V AC/DC

- cavo da 10 m
- corpo compatto in gomma antiscivolo
- vetrino frontale facilmente sostituibile
- gancio orientabile
- 340 Lumen
- con LED in testa per illuminazione multidirezionale

CE



1842LED/ABM

1 018420311

1843BM

avvolgitore automatico completo di portalampada 230 Vac con attacco E27 e gabbia in acciaio

- Lampadina esclusa
- Max 60W

CE

CE



1843BM

1 018430101

1843R/BM

portalampada di ricambio per avvolgitore, con attacco lampada E27

- Lampadina esclusa

CE



IP20

1843 R/BM

1 018430131

1846LED/BM

avvolgitore automatico completo di lampada a LED, 100-240Vac

- con trasformatore di sicurezza 230/12V

CE

CE



1846LED/BM

1 018460301

Beta

1846LED/ABM

avvolgitore automatico completo di lampada a LED alimentazione 12-24V AC/DC

- Max 25W



1846LED/ABM

1 018460311

1846R-LED/BM

lampade di ricambio a LED

12-24V - AC-DC



1846R-LED/BM

1 018460331

1847P

tester combinato di tensione e di continuità

6÷690V AC/DC



DATI TECNICI

Campo di tensione: 6÷690V AC/DC
Gamma di frequenza: 0÷100Hz
Resistenza a tensioni di punta: 8 kV
Resistenza d'entrata: ≥300kΩ
Corrente d'entrata: Is < 2,5 mA a 690V
Prova di continuità: <500 kΩ
2 pile AAA

1847P

1 018470010

1847K

rilevatore di tensione AC senza contatto con mini-torcia LED



Campo di rilevamento: 200÷1000V AC
50/60 Hz

1847K
L mm
180

1 018470101

1848

avvolgitore automatico con presa Schuko

- Max 1600 W a cavo svolto
- Max 1200 W a cavo avvolto



1848

1 018480015

1850B

pistola termica 2 velocità

- Pos. I 240 l/min 300°C
- Pos. II 450 l/min 500°C



1850B
L mm
240
H mm
190

1 018500011

1850C

pistola termica con regolazione elettronica

- Pos. I 150-250 l/min 50°C
- Pos. II 150-500 l/min 50-650°C

- Display digitale.
- Pulsanti regolazione temperatura e portata del flusso.
- 4 programmi memorizzati in origine e possibilità di personalizzazioni

- Prog 1 250°C ca. 350 l/min
- Prog 2 350°C ca. 400 l/min
- Prog 3 450°C ca. 500 l/min
- Prog 4 550°C ca. 400 l/min



1850C
L mm
255
H mm
210

1 018500015

1850U...

ugelli per 1850B e 1850C

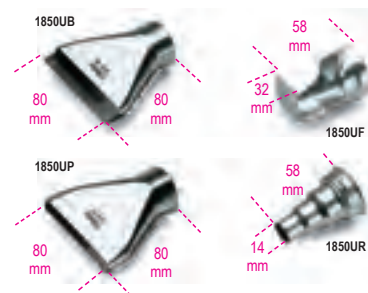

Model	Code	Qty	Part No.
1850UB	B-C	1	018500100
1850UF	B-C	1	018500101
1850UP	B-C	1	018500102
1850UR	C	1	018500103

1851VK

pistola per colla a caldo con 12 stick di colla termofusibile in valigetta
Ø 11 e 12 mm



1851VK

1 018510058

320x250x50 mm

1851VK-12C

12 stick di colla termofusibile

Ø 11 mm



1851VK-12C

1 018510062

1852R1750

riscaldatore ad induzione portatile

CE



- riscalda e sblocca bulloni, dadi, mozzi e cuscinetti particolarmente bloccati senza l'utilizzo di fiamme
- permette di scaldare qualsiasi tipo di metallo ferromagnetico

Dotazione:

- due serpentine frontali con diametro 19 e 26 mm per sblocco dadi
- una serpentina piatta per scaldare le superfici
- una serpentina flessibile lunga 800 mm
- fornito in valigetta di plastica

Dati tecnici:

- tensione di ingresso: 230V AC, 50/60 Hz
- corrente di ingresso: max. 7,5A
- potenza: max. 1.75 kW

VANTAGGI

Risparmio di tempo: riscaldamento veloce e con grande precisione

Sicurezza anti incendio: non genera fiamme, massima sicurezza per l'operatore

Praticità: utilizzabile con una sola mano e serpentine facilmente intercambiabili

CAMPI DI APPLICAZIONE

Automotive
Manutenzione industriale
Industria aeronautica
Industria navale
Industria petrolchimica

1852 R1750

1 018520175

200x140x75 mm - 4,5 kg

1852S-L

serpentine laterali



	Ø mm	
1852 S-L19	19	1 018520501
1852 S-L20	20	1 018520502
1852 S-L23	23	1 018520503
1852 S-L26	26	1 018520504
1852 S-L32	32	1 018520505
1852 S-L38	38	1 018520506
1852 S-L45	45	1 018520507

1852 S-F

serpentina frontale



	Ø mm	
1852 S-F19	19	1 018520508
1852 S-F20	20	1 018520509
1852 S-F23	23	1 018520510
1852 S-F26	26	1 018520511
1852 S-F32	32	1 018520512
1852 S-F38	38	1 018520513
1852 S-F45	45	1 018520514

1852 S-FLESS

serpentina flessibile



1852 S-FLESS

1 018520515

1852 S-PIATTE

serpentina piatta



1852 S-PIATTE

1 018520516

1860K/160A

saldatrici inverter ad elettrodo in corrente continua (DC).
adatte per **motogeneratori**, compatte e facili da trasportare
fornite di valigetta, cavi, martospazzola e traccolla.

funzioni arc force, hotstart, anti-sticking, protezione termostatica



Corrente di regolazione: 5+155A

Alimentazione: 1x230V

Potenza assorbita: MAX 3,7 KVA

Fattore di utilizzo (40°C):

35% - 150 A

60% - 130 A

100% - 100 A

Fusibile ritardato: 20 A

Protezione: IP21

Temperatura di esercizio: -15/+40° C (+5/+104° F)

Elettrodi utilizzabili: Ø 1.5 - 4mm rutilici, basici, inox, ghisa, ecc.

1860K/160A

1 018600160

500x400x150 mm 4,2 kg

1860R/C

cavi e pinze per inverter 1860K

1860R/C

1 018600501

7042LCD

maschera LCD ad oscuramento automatico, per saldatura ad elettrodo; MIG/MAG; TIG e plasma.

alimentazione a celle solari e batterie al litio per una durata eccezionale del filtro LCD

- area di visuale 98x43 mm
- tonalità di oscuramento DIN 9-13 con regolazione esterna
- protezione UV/IR
- tempo d'oscuramento 1/25000 s
- tempo di rischiaramento 0.25-1s
- sensibilità e ritardo dell'oscuramento regolabili
- accensione e spegnimento automatici
- funzione di smerigliatura
- forma ottimizzata per agevolare la respirazione a schermo abbassato



CE

7042LCD

1 070420001

7042LCD/RV

vetrino paragraffi esterno per 7042LCD

7042LCD/RV

2 070420101

7042LCD/RV-INT

vetrino interno per 7042LCD

7042LCD/RV-INT

2 070420102

Beta

1870

aspiratore 20 litri per solidi e liquidi

- motore by-pass monostadio
- tensione 230/240 V
- frequenza 50/60 Hz
- potenza Max 1200 W
- portata d'aria l/sec. 58
- depressione Max 190 mbar
- capienza Max bidone 20 l in PP antistatico
- emissioni acustiche <70 dB(A)
- lunghezza cavo 5 m
- carrello porta accessori

ACCESSORI IN DOTAZIONE Ø 36 mm

- 1 tubo corrugato completo di impugnatura ergonomica
- 2 tubi rigidi di prolunga
- 1 spazzola multiuso per pavimenti e liquidi
- 1 bocchetta a lancia

SISTEMI FILTRANTI

- 1 cartuccia filtro aria superficiale 1900 cm² - 12 micron nom.
- 1 filtro anti-schiuma PPI 45/PPI 30

CE



IPX4

1870

1 018700020

1872

aspiratore 35 litri per solidi e liquidi

- motore by-pass bistadio
- tensione 230/240 V
- frequenza 50/60 Hz
- potenza Max 1100 W
- portata d'aria l/sec. 55
- depressione Max 220 mbar
- capienza Max bidone 35 l in PE-HD antistatico
- emissioni acustiche <68 dB(A)
- lunghezza cavo 6 m

ACCESSORI IN DOTAZIONE Ø 45 mm

- 1 tubo corrugato completo di impugnatura ergonomica
- 2 tubi di prolunga in alluminio
- 1 spazzola snodata per pavimenti e moquette
- 1 telaio spazzola combinata
- 1 bocchetta imbottiti
- 1 inserto con gomme raccogli liquidi
- 1 bocchetta a lancia

SISTEMI FILTRANTI

- 1 sacco in carta filtro
- 1 cartuccia filtro superficiale 1900 cm² 12 micron nom.
- 1 filtro anti-schiuma PPI 45/PPI 30
- 2 post-filtri in PET accoppiato a PP

CE



IPX4

1872

1 018720035

1873

aspiratore 30 litri per solidi e liquidi, bidone in acciaio INOX

- motore by-pass bistadio
- tensione 230/240 V
- frequenza 50/60 Hz
- potenza Max 1100 W
- portata d'aria l/sec. 55
- depressione Max 220 mbar
- capienza Max bidone 30 l in acciaio Inox
- emissioni acustiche <61 dB(A)
- lunghezza cavo 6 m
- carrello porta accessori

ACCESSORI IN DOTAZIONE Ø 45mm

- 1 tubo corrugato completo di impugnatura ergonomica
- 2 tubi di prolunga in acciaio inox
- 1 telaio spazzola industriale
- 1 inserto industriale moquette
- 1 inserto industriale con gomme raccogli liquidi
- 1 bocchetta a lancia

SISTEMI FILTRANTI

- 1 sacco in carta filtro
- 1 cartuccia filtro superficiale 1900 cm² 12 micron nom.
- 1 filtro anti-schiuma PPI 45/PPI 30

CE



1873

1 018730030

1874

aspiratore 50 litri per solidi e liquidi, bidone in acciaio INOX

- motore by-pass bistadio
- tensione 230/240 V
- frequenza 50/60 Hz
- potenza Max 1350 W
- portata d'aria l/sec. 55
- depressione Max 240 mbar
- capienza Max bidone 50 l in acciaio Inox
- emissioni acustiche <63 dB(A)
- lunghezza cavo 6 m
- carrello porta accessori

ACCESSORI IN DOTAZIONE Ø 45mm

- 1 tubo corrugato completo di impugnatura ergonomica
- 2 tubi di prolunga in acciaio inox
- 1 telaio spazzola industriale
- 1 inserto industriale moquette
- 1 inserto industriale con gomme raccogli liquidi
- 1 bocchetta a lancia

SISTEMI FILTRANTI

- 1 sacco in carta filtro
- 1 cartuccia filtro superficiale 5200 cm² 12 micron nom.
- 1 filtro anti-schiuma PPI 45/PPI 30

CE



1874

1 018740050

1870-20/5S

5 sacchi in carta orizzontali per 1870



1870 20/5S

1 018700021

1870-72 /FC

filtro a cartuccia 1900 cm² 12 micron nominali per 1870 - 1872 - 1873



1870-72 /FC

1 018700026

Beta

1870-72/FL

filtro per aspirazione liquidi
per 1870 - 1872 - 1873 - 1874



1870-72/FL



1 018700027

1872-35/5S

5 sacchi in carta verticali per 1872



1872 35/5S



1 018720036

1873-30/5S

5 sacchi in carta verticali per 1873



1873 30/5S



1 018730031

1874-50/5S

5 sacchi in carta verticale per 1874



1874 50/5S



1 018740051

1874-50/FC

filtro a cartuccia 5200 cm² 12 micron nominali
per 1874



1874 50/FC



1 018740056

1877

recuperatore olio esausto carrellato
con serbatoio da 90 l

- indicatore di livello
- coppa di grande diametro con griglia scolafiltro capacità 12 l
- svuotamento pneumatico del serbatoio con tubo da 1,8 m
- vaschetta portautensili

CE



1877



1 018770008

1877A

recuperatore/aspiratore olio esausto, carrellato
con serbatoio da 90 l e precamera

- indicatore di livello
- coppa di grande diametro con griglia scolafiltro capacità 12 l
- precamera trasparente capacità 9,5 l
- tubo aspirazione da 1,8 m
- svuotamento pneumatico del serbatoio con tubo da 1,8 m
- vaschetta portautensili

In dotazione:

- 1 sonda rigida Ø 5x700 mm
- 1 sonda flessibile Ø 5x700 mm
- 1 sonda rigida Ø 6x600 mm
- 1 sonda flessibile Ø 6x700 mm
- 1 sonda flessibile Ø 7x700 mm
- 1 sonda flessibile Ø 8x700 mm
- adattatori per VW, BMW, CITROËN

CE



1877A



1 018770080

1878 3

vaschetta per recupero olio
mozzi truck
scarico dell'olio con salvagocia



1878 3

lit
3



1 018780003

1878 11

vaschetta per recupero liquidi

- capacità Massima 11 l
- tappo scarico liquidi
- paratia interna per evitare la fuoriuscita dei liquidi durante il trasporto



1878 11



1 018780011

1878 30

vasca per recupero liquidi

- capacità Massima 30 l
- griglia anti schizzi
- dotata di 4 ruote pivottanti

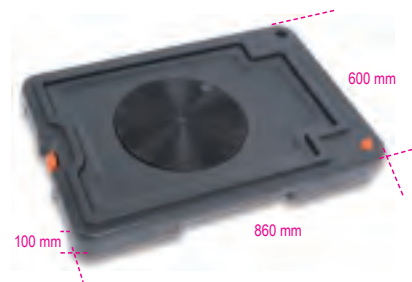

1878 30



1 018780030

1879

aspiratore liquidi manuale e pneumatico
da 9,5 Litri



1879



1 018790001

1879R/K4

kit di 4 tubi di ricambio per aspiratore liquidi 1879



1879R/K4

1 018790504

1880

pompa manuale per fusti olio

- per olio
- non usare con liquidi a base acquosa, solventi acidi, gasolio, benzina e simili
- completa di attacco fusto, tubo telescopico e beccuccio di mandata



1880 gr 240

1 018800001

1881

pompa pneumatica per fusti olio rapporto 3:1

- pressione di lavoro da 6 a 8 bar
- consumo aria 230 l/min
- per olio
- non usare con liquidi a base acquosa, solventi acidi, gasolio, benzina e simili
- completa di attacco fusto e tubo telescopico



1881 l/min 14

1 018810001

1882

pistola olio con estremità flessibile e salvagocchia automatico

- attacco 1/2"
- portata massima 65 l/min
- pressione massima di esercizio 100 bar
- possibilità di bloccare la leva di erogazione



1882

1 018820010

1883

contaltri digitale per olio

- attacco 1/2"
- rivestimento in gomma anti urto
- pila 1 CR2 (inclusa)
- portata Max: 0÷35 l/min (0÷9 gal/min)
- pressione Max: 50 bar (750 psi)
- viscosità: 8÷5000 mPas
- tolleranza: ±0,5%

CE



1883

1 018830035

1883NC

niplex maschio-maschio 1/2 per unire art. 1882 e 1883



1883NC

1 018830135

1884

attrezzo per l'inserimento di olio nei cambi manuali, automatici e nei differenziali con 12 adattatori per la connessione diretta



1884

1 018840010

AT-101	FORD
AT-102	UNIVERSAL (Bmw, Honda, Nissan...)
AT-103	VW-AUDI
AT-104	VW-AUDI-PORSCHE
AT-105	VW-AUDI-MINI COOPER
AT-106	MERCEDES
AT-107	DSG
AT-108	VW-AUDI CVT
AT-109	VOLVO
AT-110	TOYOTA-LEXUS
AT-111	SKODA
AT-112	VW Passat/Tiguan <2007

1884/C12

cassetta di 12 adattatori per 1884

- inclusa nel 1884



1884/C12

1 018840100

1889

base in acciaio per movimentazione e stoccaggio di 2 fusti da 200 l

- verniciata completamente a caldo a polvere epossidica
- facilmente trasportabile con carrello elevatore a forche o transpallet
- supporto non sovrapponibile

CE

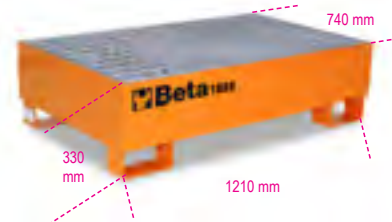

1889

1 018890200

2252

seggolino con rotelle

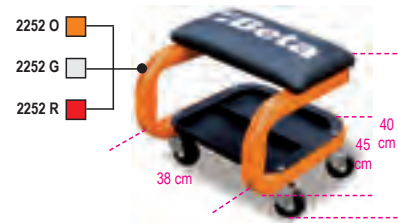

2252 O

1 022520001

2252 G

1 022520002

2252 R

1 022520003

2252KR4

4 ruote di ricambio seggiolino



2252KR4

1 022520900

3000M/LT

lettino sottomacchina

- Rivestimento in PVC con imbottitura in gomma piuma per un elevato comfort.

REGOLAZIONE DEL CUSCINO TRAMITE PISTONE A MOLLA PROGRESSIVA



3000M/LT 1 030000220
 7,3 kg

3000M/RLS

ruota di ricambio lettino sottomacchina



3000M/RLS 1 030000206

3002

lettino sottomacchina e seggiolino

- struttura in acciaio
- rivestimento in PVC con imbottitura
- possibilità di regolare la posizione rapidamente: lettino o seggiolino

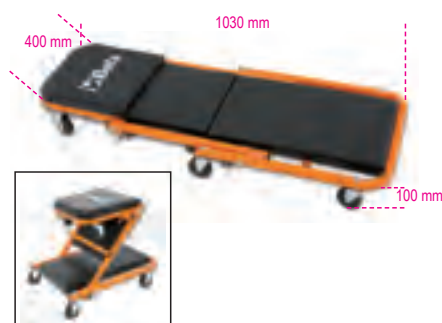

3002 1 030020001

3002/RLS

6 ruote di ricambio per lettino sottomacchina. 3002



3002/RLS 1 030020501

3003

lettino sottomacchina in plastica antiurto

- Ø ruote: 76 mm



3003 1 030030001

3003/RLS

6 ruote di ricambio per lettino sottomacchina 3003



3003/RLS 1 030030501

3007

carrello sottoscocca per veicoli senza meccanica anteriore/posteriore

- per movimentare agevolmente i veicoli privi di avantreno o retrotreno durante le fasi di lavorazione
- 4 ruote pivotanti, di cui 2 con freno, adatte all'uso in forno di verniciatura
- 2 supporti scorrevoli per adattarsi a tutti i telai
- portata massima 800 kg

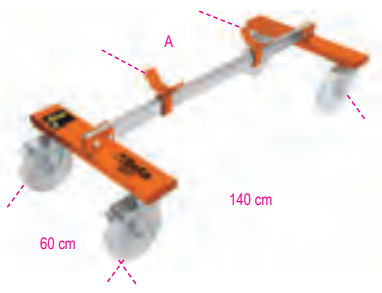

3007 1 030070001

3008

sollevatore e posizionario ruote Truck singole e gemellari

- portata massima 700 kg
- altezza minima 140 mm
- altezza massima 660 mm
- interasse rulli 470+740 mm
- sicurezza idraulica in caso di sovraccarico
- ruote anteriori pivotanti



3008 1 030080100

3009

carrello per movimentazione veicoli

- portata Max 550 kg
- 4 rulli basculanti
- larghezza rulli 200 mm
- per ruote fino a 240 mm di larghezza



A 400+850 mm B 600 mm 1 030090001

3009R/GR4

gruppi 4 ruote carrelli 3009 R/GR4



3009 R/GR4 1 030090501

3010/T...

coppia cavalletti



C max kg	H min mm	H Max mm	H1 mm	L mm	L1 mm
2000	280	425	245	185	165

3010/T2 1 030100002

C max kg	H min mm	H Max mm	H1 mm	L mm	L1 mm
3000	285	430	250	180	195

3010/T3 1 030100003

C max kg	H min mm	H Max mm	H1 mm	L mm	L1 mm
6000	400	580	340	245	280

3010/T6 1 030100006

C max kg	H min mm	H Max mm	H1 mm	L mm	L1 mm
10000	471	735	420	330	290

3010/T10 1 030100010

3011/T

sollevari idraulici a bottiglia

CE



C max	H min	H Max	L
kg	mm	mm	mm
3500	170	366	86

3011/T3,5 1 030110035

C max	H min	H Max	L
kg	mm	mm	mm
5000	203	467	118

3011/T5 1 030110050

C max	H min	H Max	L
kg	mm	mm	mm
10000	220	484	114

3011/T10 1 030110100

C max	H min	H Max	L
kg	mm	mm	mm
15000	230	497	113

3011/T15 1 030110150

C max	H min	H Max	L
kg	mm	mm	mm
20.000	245	521	115

3011/T20 1 030110200

3012

staffe sostegno motore



L	C max
mm	kg
1500	500
1800	400

3012C

staffa sostegno motore inferiore

ideale per auto e veicoli commerciali



3012C 1 030120255

3012I

staffa sostegno motore inferiore

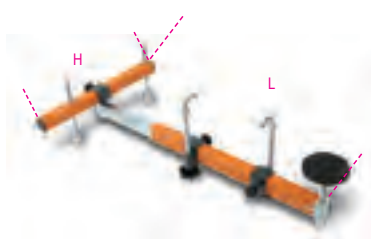

3012I	L	H
	mm	mm
	630+960	190

3014

cavalletto sostegno motore



3014 1 030140010

3014R/GR5

5 ruote di ricambio per cavalletto sostegno motore 3014



3014R/GR5 1 030140501

3014 SAR

cavalletto sostegno motore richiudibile

- facilmente richiudibile con notevole riduzione degli ingombri
 - permette la rotazione di 360° del motore o del cambio
 - garantisce la massima sicurezza e stabilità durante gli interventi
- Portata massima: 450 kg



3014 SAR 1 030140360

3014SAR/RR

4 ruote di ricambio per cavalletto sostegno motore 3014SAR



3014SAR/RR 1 030140370

3014SAR/1

vasca di raccolta liquidi per 3014 SAR

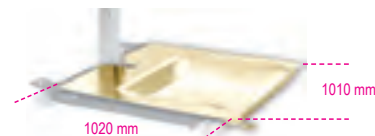

3014 SAR/1 1 030140361

1020x1010x11 mm

3014SAR/2

staffa per il fissaggio della trasmissione sul cavalletto 3014 SAR

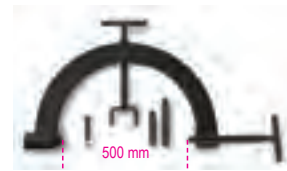

3014 SAR/2 1 030140362

3025

gru idraulica pieghevole con pompa a doppio effetto
Portata massima 1 t

CE



3025 3025 1 030250001

3025/RF

2 ruote fisse di ricambio per gru idraulica 3025



3025/RF 1 030250901

3025/RG

2 ruote girevoli di ricambio per gru idraulica 3025



3025/RG

1 030250902

3025/PF

pinza movimentazione fusti

portata massima 300 kg

CE



3025/PF A mm B mm
550+640 70

1 030250011

3026 0,3

sollevatore idraulico da fossa e sottoponte

Portata massima: 300 kg

CE



3026 0,3

1 030260003

3026/R0,3

4 ruote girevoli di ricambio per sollevatore idraulico 3026 0,3



3026/R0,3

1 030260903

3026 0,5

sollevatore idraulico da fossa e sottoponte

Portata massima 500 kg

CE



3026 0,5

1 030260005

3026/R0,5

4 ruote girevoli di ricambio per sollevatore idraulico 3026 0,5



3026/R0,5

1 030260905

3026 1,0

sollevatore idraulico da fossa e sottoponte

Portata massima 1t



3026 1,0

1 030260010

3026/S

supporto orientabile per trasmissioni con bocche di riduzione per sollevatori 3026

portata massima 500 kg



3026/S

1 030260501

3026/SP

supporto universale per trasmissioni

permette ad un solo operatore di smontare e rimontare le trasmissioni di autovetture, veicoli commerciali e fuoristrada con rapidità e sicurezza.



3026/SP

1 030260505

3027 10

pressa idraulica da banco con pistone mobile

capacità massima: 10 t

CE



3027 10

90 kg

1 030270010

3027 20

pressa idraulica con pistone mobile

capacità massima: 20 t

CE



3027 20

140 kg

1 030270020

3027 30

pressa idraulica con pistone mobile ed argano

capacità massima: 30 t

CE



3027 30

1 030270030

230 kg

3027 50

pressa idraulica con pistone mobile ed argano

capacità massima: 50 t

CE



3027 50

1 030270050

350 kg

3027/KP

serie di cacciapine e piastra per pressa 3027

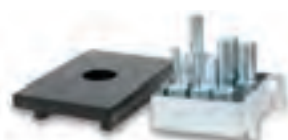

3027/KP10	3027 10	1	030270510
3027/KP20	3027 20	1	030270520
3027/KP30	3027 30	1	030270530
3027/KP50	3027 50	1	030270550

1 030270510
1 030270520
1 030270530
1 030270550

3027/KPP50

comando a pedale per pressa idraulica 3027 20-30-50



3027/KPP50

1 030270555

3030/2T

sollevatore idraulico ribassato 2 t a 6 ruote

- doppie ruote anteriori basculanti in materiale plastico (PTFE)
- ottima manovrabilità del sollevatore su pavimentazioni sconnesse e irregolari
- portata massima: 2 tonnellate

CE



3030

1 030300020

43 kg

3030/2T-R5

ruota anteriore con perno per sollevatore 3030 2T



3030/2T-R5

1 030300505

3030/2T-R6

ruota posteriore di ricambio per 3030/2T



3030/2T-R6

1 030300506

3030/2TRP

piattello di ricambio in gomma 85 mm per 3030/2T



3030/2TRP

5 030300501

3033/3T

sollevatore idraulico 3t versione lunga

- per utilizzo su veicoli commerciali
- portata massima: 3 tonnellate
- ruote in poliammide

CE



3033

1 030330030

3035

carrello trasporta pneumatici

- per trasportare agevolmente pneumatici fino ad un massimo di 980 mm di diametro
- la solida struttura permette di movimentare i pneumatici senza doverne sopportare fisicamente il peso
- utilizzabile come piano d'appoggio, grazie al blocco della posizione in orizzontale
- 2 ruote Ø 260 mm
- 2 ruote Ø 125 mm
- altezza massima trasportabile 1,60 m
- portata massima 200 kg
- forche regolabili in 2 posizioni: prima posizione apertura massima 880 mm seconda posizione apertura massima 980 mm



3035

1 030350100

3040

cavalletto posteriore per moto regolabile

- Verniciatura nera opaca
- Porta cursore in poliammide
- 4 ruote in gomma termoplastica



3040 1 030400001

3040A/1

coppia cursori a V per 3040



3040A/1 1 030400501

3040A/2

coppia cursori a L in gomma per 3040



3040A/2 1 030400502

3040A/6-8-10

coppia nottolini in alluminio per 3040A/1



3040A/6 1 030400506

M6x1 mm
Aprilia, Yamaha, Triumph

3040A/8 1 030400508

M8x1.25 mm
Suzuki, Honda, Ducati

3040A/10 1 030400510

M10x1.25 mm
Kawasaki

3041

cavalletto anteriore per moto regolabile

- Verniciatura nera opaca
- Porta cursore in poliammide
- 4 ruote in gomma termoplastica



3041 1 030410001

3041A/11

coppia cursori a rulli per 3041



3041 A/11 1 030410511

3041A/15

coppia cursori a cono per 3041



3041 A/15 1 030410515

3041T

cavalletto anteriore alto regolabile per moto con pinza radiale

- Verniciatura nera opaca
- Porta cursore in poliammide
- 4 ruote in gomma termoplastica



3041T 1 030410011

3041T/17

coppia cursori a L in gomma per pinze radiali per 3041T



3041T/17 1 030410517

3042

cavalletto anteriore per canotto di sterzo moto

- Verniciatura nera opaca
- 4 ruote in gomma termoplastica
- Include kit di 6 perni Ø 13 - 14 - 16 - 20 - 26,5



3042 1 030420001

3042/K6P

kit di 6 perni per cavalletto moto 3042

(già inclusi nel 3042)



3042/K6P 1 030420101

3043

cavalletto per moto con monobraccio sinistro

- Porta cursore in acciaio
- Verniciatura nera opaca
- 4 ruote in gomma termoplastica



3043 1 030430001

3043A/41÷47

perno per 3043



	Ø mm		
3043A/41 Ducati	21,8	1	030430541
3043A/42 Triumph	27,5	1	030430542
3043A/43 MV - Ducati	42	1	030430543
3043A/44 Ducati 1098	40	1	030430544
3043A/45 Honda	28,6	1	030430545
3043A/46 BMW F800S	30	1	030430546
3043A/47 BMW K,R,S	52,9	1	030430547

3061/2T

sollevatore pneumatico 2 t - 2 stadi



CE

Dotato di:

- membrana alta resistenza a tre strati e guida telescopica interna
- dispositivo d'arresto a fine corsa e valvola di sicurezza per carichi eccessivi
- possibilità di utilizzo anche sui ponti sollevatori

DATI TECNICI

portata: 2 t

peso: 14 kg

pressione di alimentazione: 8-10 bar

altezza: min.132 - max. 326 mm

3061/2T 1 030610020

3061/2T-P50

prolunga da 50 mm per 3061/2T



3061/2T-P50 1 030610021

3061/2T-P100

prolunga da 100 mm per 3061/2T



3061/2T-P100 1 030610022

3063/2,5T

sollevatore oleopneumatico a carrello da 2,5 t



Particolarmente indicato per l'utilizzo su autovetture e veicoli commerciali
Ideale per officine, gommisti e carrozzerie

DOTATO DI:

- rientro automatico del braccio
- controllo velocità a pieno carico

DATI TECNICI
portata: 2,5t
peso: 75 kg
pressione di alimentazione: 8-10 bar
consumo d'aria: 400 l/min

3063/2,5T 1 030630125

3065/40-20T

sollevatore oleopneumatico 40-20 t



- indicato per utilizzo su mezzi pesanti
- pratico e maneggevole per trasporto anche su officine mobili
- rientro automatico dei pistoni
- due valvole di discesa con controllo velocità sotto carico
- include due prolunghe da 70 e 120 mm

DATI TECNICI
portata: 40-20 tonnellate
peso: 39 kg
pressione di alimentazione: 8-10 bar
consumo d'aria: 400 l/min

3065/40-20T 1 030650200

3067/70-13T

sollevatore oleopneumatico 70-43-23-13 t



Versione lunga, adatta all'utilizzo su autocarri, autoarticolati, autobus e macchine agricole

- rientro automatico dei pistoni
- due valvole di discesa con controllo velocità sotto carico
- include due prolunghe da 70 e 120 mm

DATI TECNICI
portata: 70-43-23-13 tonnellate
peso: 74 kg
pressione di alimentazione: 8-10 bar
consumo d'aria: 600 l/min

3067/70-13T 1 030670130



Beta

UTENSILI ISOLATI ⚡ 1000 V

● Gli utensili isolati Beta sono prodotti studiati per garantire la sicurezza di installatori e manutentori elettrici. Tutti gli utensili isolati permettono di operare su impianti in tensione fino a 1000V in corrente alternata e 1500V in corrente continua.

Per garantire il massimo livello di qualità e di prestazioni e accertare l'idoneità e la conformità alla norma EN 60900, ogni singolo utensile è sottoposto a un approfondito processo di verifica che comprende: prove di resistenza dell'impugnatura allo sfilamento e alla propagazione della fiamma e prova di tensione applicata a 10000 Volt.

Per assortimenti e termoformati vedere le rispettive sezioni.

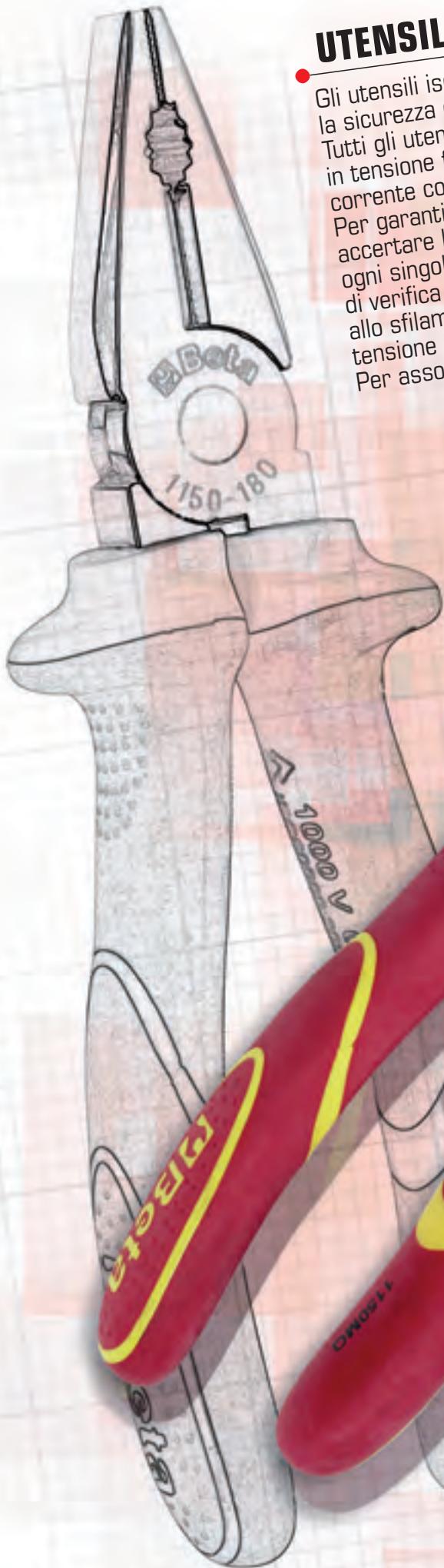

Istituto Italiano del Marchio di Qualità - I



Verband der Elektrotechnik
Elektronik Informationstechnik - D

52MQ

chiavi a forchetta semplici



EN 60900

mm	L mm		
10	110	1	000520110
11	120	1	000520111
12	132	1	000520112
13	140	1	000520113
14	146	1	000520114
15	166	1	000520115
17	168	1	000520117
19	176	1	000520119
22	200	1	000520122
24	225	1	000520124

89MQ

chiavi poligonali semplici



EN 60900

mm	L mm		
10	170	1	000890110
11	180	1	000890111
12	190	1	000890112
13	195	1	000890113
14	200	1	000890114
15	210	1	000890115
17	218	1	000890117
19	240	1	000890119
22	255	1	000890122
24	280	1	000890124

110MQ

chiave regolabile a rullino con scala graduata



EN 60900

L mm	A max mm		
250	30	1	001100525

606MQ/50

chiave dinamometrica a scatto con cricchetto reversibile



EN 60900
UNI EN 26789
ISO 6789

Nm	Kgfm	lbf.ft	L1 mm	L mm	g
5÷50	0,5÷5	4÷40	90	375	1130

L mm	Ø mm		
606MQ/50		1	006060705

850MQ

portainseri magnetico isolato con impugnatura bimateriale

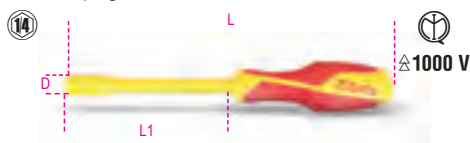

IMQ CSV

L mm	L1 mm	D mm		
233	125	12,5	1	008500910

920MQ/A

chiavi a bussola esagonali



EN 60900

mm	Ø mm	L mm	Ø1 mm		
8	21,5	57	27,5	1	009200238
10	21,5	57	27,5	1	009200240
11	21,5	57	27,5	1	009200241
12	23,0	57	27,5	1	009200242
13	23,0	57	27,5	1	009200243
14	23,0	57	27,5	1	009200244
17	30,0	57	27,5	1	009200247
19	32,2	57	27,5	1	009200249
22	36,0	57	27,5	1	009200252
24	39,0	57	27,5	1	009200254

920MQ/PE

chiavi a bussola maschio esagonale



EN 60900

Ø mm	L mm	L1 mm			
5	28,5	94,5	10,5	1	009200265
6	28,5	94,5	10,5	1	009200266
8	28,5	94,5	10,5	1	009200268

920MQ/21

prolunga quadro maschio e femmina 1/2"



EN 60900

L mm	Ø mm		
135	28	1	009200804

920MQ/22

prolunga quadro maschio e femmina 1/2"



EN 60900

L mm	Ø mm		
264	30	1	009200805

920MQ/T

quadro maschio 1/2", a T



EN 60900

L mm	L1 mm		
200	163	1	009200807

920MQ/55A

cricchetto reversibile con attacco quadro maschio 1/2" con sistema di bloccaggio bussola



EN 60900

L mm	D mm	A mm		
240	50	89	1	009200809

920MQ/C16

9 chiavi a bussola esagonali
3 chiavi a bussola esagonali maschio e 4 accessori



EN 60900

920MQ/C16		
	1	009200917

920MQ/A 8 - 10 - 12 - 13 - 14 - 17 - 19 - 22 - 24 mm

920MQ/PE 5 - 6 - 8 mm

920MQ/21 135 mm

920MQ/22 264 mm

920MQ/55A

920MQ/T

420x280x60 mm - 5,2 kg

943MQ

chiavi a bussola esagonale con impugnatura



EN 60900

mm	L mm	L1 mm	D mm		
5,5	233	125	12,2	1	009430235
6	233	125	12,5	1	009430236
7	240	125	14,3	1	009430237
8	240	125	15,3	1	009430238
10	252	125	17,3	1	009430240
13	252	125	21,3	1	009430243

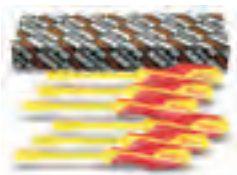

943MQ/S6
5,5-6-7-8-10-13 mm

1 009430250

951MQ

chiavi a T maschio esagonale

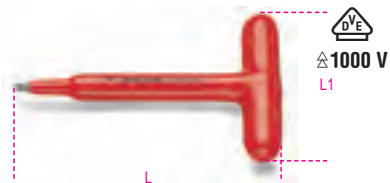

1000 V
L1

EN 60900

mm	L mm	L1 mm	
4	165	105	1 009510704
5	170	105	1 009510705
6	168	105	1 009510706
8	165	105	1 009510708

993MQ

pinzetta a molla a punte curve arrotondate, zigrinate



1000 V
L

EN 60900

L mm	
147	1 009930040

994MQ

pinzetta a molla a punte diritte arrotondate, zigrinate



1000 V
L

EN 60900

L mm	
145	1 009940040

1010MQ

pinze a becchi tondi lunghi



1000 V
L1

EN 60900

L mm	L1 mm	
160	51,5	1 010100096

1048MQ

pinze regolabili a cerniera chiusa

• Finitura cromata



1000 V
L1

EN60900

L mm	A max mm	L1 mm	
250	48	39	1 010480315

1082MQ

tronchesi a taglienti diagonali



1000 V
L1

EN 60900

L mm	L1 mm	mm	
140	20	1,6	1 010820094
160	22	1,6	1 010820096

1084MQ

tronchesi a grande effetto a taglienti diagonali



1000 V
L1

EN 60900

L mm	L1 mm	mm	
200	26	2,0	1 010840100

1088MQ

tronchesi a taglienti frontali



1000 V
L1

EN 60900

L mm	L1 mm	mm	
160	7	1,6	1 010880096

2115P L-MQ32



2115P L-MQ32

235

1128MQ

forbici per elettricisti
lame in acciaio inossidabile
con microdentatura



1000 V
L1

IEC60900

L mm	L1 mm	
145	45	1 011280101

1132MQ

tagliacavi
per cavi flessibili in rame e alluminio



1000 V
L1

EN 60900

L mm	mm	
230	18	1 011320193

1142MQ

pinza spellafili



1000 V
L1

EN 60900

L mm	mm ²	
160	0,5÷6	1 011420096

1150MQ

pinze universali
cromate lucide



1000 V
L1

EN 60900

L mm	L1 mm	mm	
160	37	1,6	1 011500096
180	39	1,8	1 011500098
200	43	2,0	1 011500100
220	46	2,0	1 011500102

1162MQ

pinze a becchi piatti
lunghissimi dritti



1000 V
L1

EN 60900

L mm	L1 mm	mm	
160	56	1,6	1 011620096
200	76	1,6	1 011620100

1164MQ

pinze a becchi piatti
lunghe e piegati

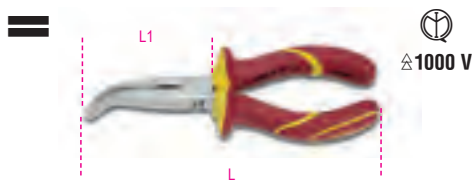

L mm	L1 mm	mm	
160	54	1,6	1 011640096
200	76	1,6	1 011640100

1166MQ

pinze a becchi mezzotondi
lunghe e dritte

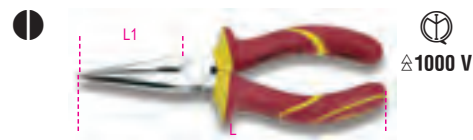

EN 60900

L mm	L1 mm	mm	
160	56	1,6	1 011660096
200	76	1,6	1 011660100

1168MQ

pinze a becchi mezzotondi
lunghe e piegati

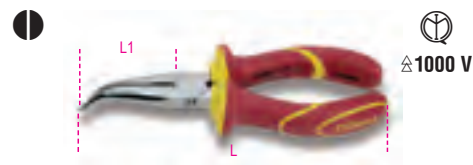

EN 60900

L mm	L1 mm	mm	
160	50	1,6	1 011680096
200	70	1,6	1 011680100

1272MQ

giravite per viti con impronta
a croce Phillips®

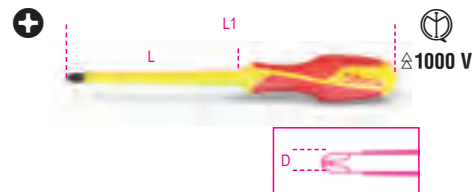

EN 60900

PHxDxL mm	L1 mm	
0x3x60	160	3 012720703
1x4,5x80	187	3 012720709
2x6x100	218	3 012720718
3x8x150	276	2 012720724
4x10x200	326	2 012720727



PHxDxL mm	L1 mm	
0x3x60	160	3 012720703
1x4,5x80	187	3 012720709
2x6x100	218	3 012720718
3x8x150	276	2 012720724
4x10x200	326	2 012720727

1273MQ/D6

serie di 6 giravite



1273MQ/D6 1 012730851

1274MQ	0,5x3x100 -0,8x4x100 1,0x5,5x125 mm
1272MQ	PH0x3x60 -PH1x4,5x80 PH2x6x100 mm

1274MQ

giravite per viti senza testa
con intaglio

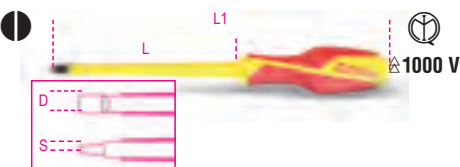

EN 60900

SxDxL mm	L1 mm	
0,4x2,5x75	175	3 012740700
0,5x3x100	200	3 012740703
0,8x4x100	207	3 012740706
1x5,5x125	232	3 012740709
1,2x6,5x150	268	3 012740712
1,2x8x175	301	2 012740715
1,6x10x200	326	2 012740718



1274MQ/S6 1 012740751

1274MQ/S6	0,5x3x100-0,8x4x100 1x5,5x125-1,2x6,5x150 1,2x8x175-1,6x10x200 mm
-----------	---

1279MQ

giravite per viti con impronta a croce
Pozidriv®-Supadriv®



EN 60900

PZ	L mm	L1 mm	
0	60	160	3 012790703
1	80	187	3 012790709
2	100	218	3 012790718
3	150	276	2 012790724



1279MQ/S4	PZ 0-1-2-3	1 012790751
-----------	------------	-------------

1725MQ

miniseghetto



1725MQ 260 85 1 017250030

1777MQ/C

coltello spellacavi isolato

per cavi multipolari



1777MQ/C 190 1 017770026

1777MQ/U

coltello spellacavi isolato

per cavi unipolari



1777MQ/U 190 1 017770011

1777RL/U

4 lame di ricambio per cutter 1777MQ/U



1777RL/U 1 017770021

1995MQ/T

tappeto isolante

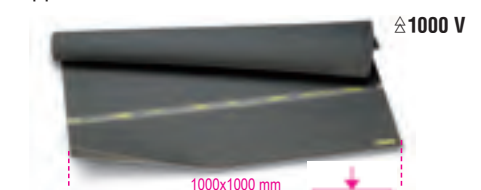

VDE 0303

1995MQ/T 1000x1000x4 1 019950030

1995MQ/G1 - G2

guanti isolanti, in lattice



EN 60903

Gr.	L mm	
1995MQ/G1	9 410	1 019950010
1995MQ/G2	10 410	1 019950013



Beta INOX STAINLESS STEEL



INOX + NO INOX = RUGGINE



INOX + INOX = NO RUGGINE

GLI UTENSILI BETA INOX POSSONO ESSERE STERILIZZATI IN AUTOCLAVE A 121 °C

Gli utensili BETA INOX possono essere utilizzati in ambienti critici, ovvero zone e aree in cui non è ammesso il livello minimo di contaminazione.

Alcuni esempi sono:

- Applicazioni nucleari
- Produzione farmaceutica - **classe C**
- Applicazioni offshore
- Laboratori biotecnologici e biomedici
- Industria alimentare.

Gli utensili Beta Inox evitano, inoltre, il fenomeno della ruggine impropria.

Quando si utilizzano utensili non realizzati in acciaio inossidabile su viti, dadi o superfici in acciaio inossidabile, dagli utensili si possono staccare particelle che innescano processi di corrosione, creando spesso problemi estetici, e, alcune volte, problemi strutturali.

Esempi di applicazione sono:

- Cantieri navali,
- Edilizia,
- Impianti solari,
- Industria automobilistica.

CARATTERISTICHE

L'accurata scelta dei materiali¹ e la sapiente ricerca dei migliori trattamenti termici conferiscono agli utensili Beta Inox caratteristiche meccaniche ampiamente superiori ai valori di norma e comparabili a quelle dei normali utensili Beta.

L'ergonomia e il design dei prodotti sono gli stessi degli utensili Beta, conosciuti e apprezzati dagli utilizzatori professionali da più di 75 anni.

L'acciaio inossidabile è riciclabile al 100%. Anche questa è una caratteristica importante.

¹ Beta Utensili utilizza acciaio AISI 420, magnetico.

42INOX

chiavi combinate,
in acciaio inossidabile



mm	L mm		
6x6	95	2	000420306
8x8	116	2	000420308
10x10	137	2	000420310
11x11	148	2	000420311
12x12	158	2	000420312
13x13	169	2	000420313
14x14	180	2	000420314
15x15	190	2	000420315
16x16	201	2	000420316
17x17	212	2	000420317
19x19	233	2	000420319



42INOX/S11			
6-8-10-11-12-13-14-15-16-17-19 mm		1	000420391



42INOX/SC9			
8-10-11-12-13-14-15-17-19 mm		1	000420387
42/SCV9I		1	000420103

42INOX-AS

chiavi combinate,
in acciaio inossidabile



"	L mm		
1/4x1/4	95	1	000420356
5/16x5/16	116	1	000420358
3/8x3/8	137	1	000420360
7/16x7/16	148	1	000420361
1/2x1/2	169	1	000420363
9/16x9/16	180	1	000420364
5/8x5/8	201	1	000420366
11/16x11/16	212	1	000420367
3/4x3/4	233	1	000420369



42INOX-AS/S9
1/4-5/16-3/8-7/16-1/2
9/16-5/8-11/16-3/4

1 000420396

96BPINOX

chiavi maschio esagonale piegate con estremità sferica, in acciaio inossidabile



mm	L mm	L1 mm	g	
2	91	22	4	4 000961441
2,5	91	22	6	4 000961442
3	101	24	11	4 000961443
4	112	29	19	4 000961444
5	131	33	32	4 000961445
6	154	36	51	4 000961446
7	164	40	65	2 000961447
8	175	44	116	2 000961448
10	197	51	189	2 000961450



96BPINOX/B6
2,5-3-4-5-6-8 mm
96BPINOX/B9
2-2,5-3-4-5-6-7-8-10 mm
96/BV

1 000961455
1 000961456
1 000961459

96BPINOX-AS

chiavi maschio esagonale piegate con estremità sferica, in acciaio inossidabile



"	L mm	L1 mm	g	
5/64	91	22	5,5	4 000961989
3/32	91	22	5,3	4 000961990
7/64	101	24	10,5	4 000961991
1/8	101	24	10,7	4 000961992
9/64	112	29	18,7	4 000961993
5/32	112	29	18,7	4 000961994
3/16	131	33	31,5	2 000961995
7/32	154	36	50,0	2 000961996
1/4	164	40	70,0	2 000961997
5/16	175	44	115,0	2 000961998
3/8	197	51	186,5	2 000961999



96BPINOX-AS/B8
5/64-3/32-1/8-5/32-3/16-7/32-1/4-5/16
96/BV

1 000962000
1 000961459

96TINOX

chiavi maschio esagonale piegate con impugnatura di manovra, in acciaio inossidabile

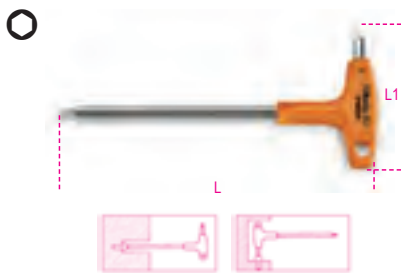

mm	L mm	L1 mm	
2.5	153	55	2 000961935
3	153	55	2 000961936
4	179	70	2 000961938
5	200	84	2 000961940
6	221	95	2 000961941
7	236	106	2 000961942
8	255	117	2 000961943
10	285	132	2 000961944



96TINOX/S5
2,5-3-4-5-6 mm
96TINOX/S8
2,5-3-4-5-6-7-8-10 mm

1 000961952
1 000961954

96TINOX-AS

chiavi maschio esagonale piegate con impugnatura di manovra, in acciaio inossidabile

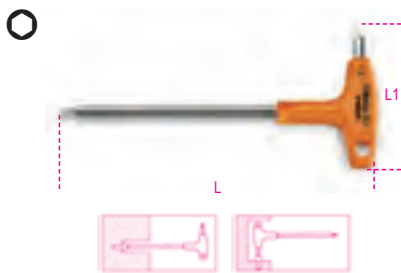

"	L mm	L1 mm	Ø mm	
3/32	153	55	3	2 000961861
7/64	153	55	4	2 000961862
1/8	179	70	4	2 000961863
9/64	179	70	5	2 000961864
5/32	200	84	6	2 000961865
3/16	200	84	6	2 000961866
7/32	221	103	7	2 000961867
1/4	236	106	8	2 000961868
5/16	255	117	10	2 000961869
3/8	285	132	12	2 000961870



96TINOX AS/S7
3/32-1/8-5/32-3/16-7/32-1/4-5/16

1 000961877

1290INOX

giravite per viti a testa con intaglio in acciaio inossidabile

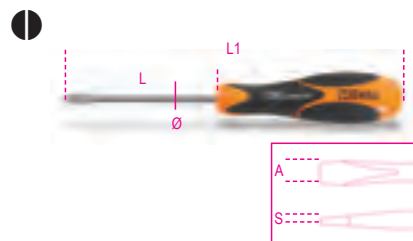

SxAxL mm	L1 mm	Ø mm	
0.4x2.5x50	146	2.5	4 012900403
0.5x3x75	171	3.0	4 012900409
0.8x4x100	196	4.0	4 012900430
1.x5.5x150	259	5.0	4 012900442
1.2x6.5x150	270	6.0	4 012900451

1292INOX

giravite per viti con impronta a croce Phillips®, in acciaio inossidabile

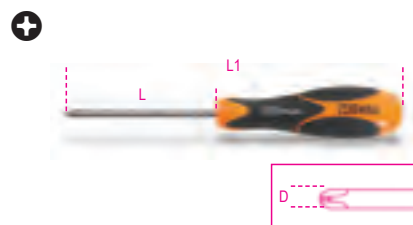

PHxDxL mm	L1 mm	
0x3x60	156	4 012920403
1x4.5x80	189	4 012920409
2x6x100	220	4 012920418

1293INOX/D8

serie giravite in acciaio inossidabile



1293INOX/D8		1 012930408
1290INOX	2,5x50-3x75	
1292INOX	4x100-5,5x150-6,5x150 mm PH0x60-PH1x80 PH2x100 mm	

C04 TSS-7

cassettiera mobile con sette cassetti completamente in acciaio inossidabile

Caratteristiche principali:

- Sette cassetti da 570 x 410 mm montati su guide telescopiche a sfera;
- 6 cassetti altezza 83 mm;
- 1 cassetto altezza 170 mm;
- 4 ruote Ø 125mm
- 2 fisse e 2 girevoli (due con freno);
- Serratura frontale centralizzata;
- **Struttura interamente in acciaio inossidabile**
- **Ruote, supporti, sfere, interno dei cassetti e relative guide in acciaio inossidabile**
- Maniglia cassetti in alluminio

63 kg



700 kg

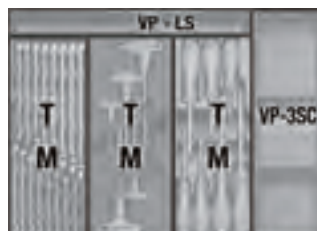

h	max
83 mm	25 kg
170 mm	30 kg

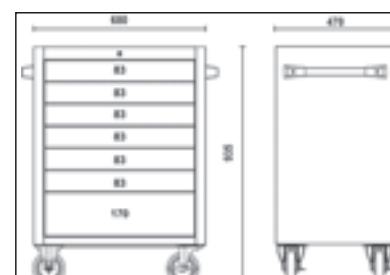
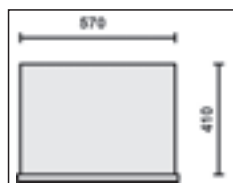

UTENSILI ANTISCINTILLA

RAME-BERILLIO Cu-Be

Gli utensili Antiscintilla **Beta** sono specifici per operare in assoluta sicurezza in ambienti a potenziale rischio di esplosioni, con presenza di liquidi o gas infiammabili, o per applicazioni che richiedono l'utilizzo di utensili amagnetici e resistenti alla corrosione.



Gli utensili antiscintilla Beta sono certificati dall'Istituto per la ricerca e il collaudo BAM, secondo la Direttiva Europea 99/92/EC.

CLASSIFICAZIONE DELLE ZONE A RISCHIO DI ESPLOSIONE			
ATEX	ALTA	MEDIO BASSA	MOLTO BASSA
GAS	ZONA 0 Area in cui è presente in permanenza o per lunghi periodi o spesso, un'atmosfera esplosiva consistente in una miscela di aria e di sostanze infiammabili sotto forma di gas, vapore o nebbia.	ZONA 1 Area in cui durante le normali attività è probabile la formazione di un'atmosfera esplosiva consistente in una miscela di aria e di sostanze infiammabili sotto forma di gas, vapore o nebbia.	ZONA 2 Area in cui durante le normali attività non è probabile la formazione di un'atmosfera esplosiva consistente in una miscela di aria e di sostanze infiammabili sotto forma di gas, vapore o nebbia e, qualora si verifici, sia unicamente di breve durata.
	ZONA 20 Area in cui è presente in permanenza o per lunghi periodi o spesso un'atmosfera esplosiva sotto forma di nube di polvere combustibile nell'aria.	ZONA 21 Area in cui occasionalmente durante le normali attività è probabile la formazione di un'atmosfera esplosiva sotto forma di nube di polvere combustibile nell'aria.	ZONA 22 Area in cui le normali attività non è probabile la formazione di un'atmosfera esplosiva sotto forma di nube di polvere combustibile nell'aria e, qualora si verifici, sia unicamente di breve durata.
POLVERI			



ATTENZIONE:

rischio di esplosione

in presenza di **ACETILENE**.

30BA

punzoni antiscintilla



Ø mm	L mm	S mm		
5	150	15	1	000300806
8	150	17	1	000300808
10	150	19	1	000300810

31BA

cacciaspina antiscintilla



Ø mm	L mm		
3	110	1	000310853
4	110	1	000310854
6	115	1	000310856
8	120	1	000310858

34BA

scalpelli piatti antiscintilla



L mm	A mm		
200	22	1	000340801
250	23	1	000340803
300	24	1	000340802

39BA

cunei antiscintilla



L mm	A mm		
150	40	1	000390801
230	40	1	000390802
250	40	1	000390803

42BA

chiavi combinate antiscintilla



Ø mm	L mm		
6x6	105	1	000420806
7x7	105	1	000420807
8x8	120	1	000420808
9x9	120	1	000420809
10x10	135	1	000420810
11x11	135	1	000420811
12x12	150	1	000420812
13x13	150	1	000420813
14x14	175	1	000420814
15x15	175	1	000420815
16x16	195	1	000420816

Ø mm	L mm		
17x17	200	1	000420817
18x18	215	1	000420818
19x19	220	1	000420819
20x20	230	1	000420820
21x21	240	1	000420821
22x22	250	1	000420822
24x24	268	1	000420824
27x27	290	1	000420827
28x28	290	1	000420828
30x30	313	1	000420830
32x32	333	1	000420832
35x35	360	1	000420835
36x36	355	1	000420836
38x38	430	1	000420838
41x41	430	1	000420841
46x46	480	1	000420846
50x50	520	1	000420850
55x55	560	1	000420855
60x60	580	1	000420860
*65x65	595	1	000420865
*70x70	630	1	000420870

42BA/AS

chiavi combinate antiscintilla



Ø mm	L mm		
3/8x3/8	128	1	000420950
7/16x7/16	135	1	000420951
1/2x1/2	140	1	000420953
9/16x9/16	163	1	000420954
5/8x5/8	177	1	000420956
11/16x11/16	195	1	000420957
3/4x3/4	215	1	000420959
13/16x13/16	230	1	000420961
7/8x7/8	235	1	000420962
15/16x15/16	256	1	000420964
1x1	266	1	000420965
1.1/16x1.1/16	283	1	000420967
1.1/8x1.1/8	297	1	000420969
1.3/16x1.3/16	308	1	000420970
1.1/4x1.1/4	324	1	000420973

55BA

chiavi a forchetta doppie antiscintilla



Ø mm	L mm		
6x7	90	1	000550801
8x9	100	1	000550802
8x10	100	1	000550795
9x11	110	1	000550797
10x11	120	1	000550803
12x13	130	1	000550804
13x14	133	1	000550799
14x15	145	1	000550805
14x17	150	1	000550806
16x17	165	1	000550807
18x19	170	1	000550809
20x22	185	1	000550811
21x23	210	1	000550813
22x24	210	1	000550815
24x26	230	1	000550817
24x27	230	1	000550818
25x28	230	1	000550819
27x29	246	1	000550820
30x32	265	1	000550822
36x38	320	1	000550826
36x41	335	1	000550828
41x46	355	1	000550829
*46x50	370	1	000550830
*50x55	385	1	000550831
*55x60	415	1	000550832

55BA/AS

chiavi a forchetta doppie antiscintilla



Ø "	L mm		
3/8x7/16	110	1	000550853
1/2x9/16	130	1	000550854
5/8x11/16	160	1	000550857
3/4x13/16	180	1	000550859
7/8x15/16	210	1	000550865
1x1.1/16	230	1	000550868
1.1/8x1.3/16	245	1	000550870
1.1/4x1.5/16	255	1	000550872

58BA

chiavi a forchetta semplici a percussione, antiscintilla



Ø mm	L mm		
17	125	1	000580817
19	125	1	000580819
22	135	1	000580822
24	150	1	000580824
27	165	1	000580827
30	180	1	000580830
32	190	1	000580832
36	210	1	000580836
38	220	1	000580838
41	230	1	000580841
46	240	1	000580846
50	255	1	000580850
*55	305	1	000580855
*60	315	1	000580860
*65	335	1	000580865
*70	370	1	000580870
*75	375	1	000580875
*80	400	1	000580880

78BA

chiavi poligonali a percussione, antiscintilla



Ø mm	L mm		
17	145	1	000780817
19	145	1	000780819
22	165	1	000780822
24	140	1	000780824
27	155	1	000780827
30	165	1	000780830
32	180	1	000780832
34	192	1	000780834
36	208	1	000780836
38	215	1	000780838
41	225	1	000780841
46	245	1	000780846
50	250	1	000780850
55	265	1	000780855
60	275	1	000780860
65	295	1	000780865
70	310	1	000780870
75	325	1	000780875
80	340	1	000780880

78BA/AS

chiavi poligonali a percussione, antiscintilla



mm	L mm		
1.1/4	177	1	000780910
1.7/16	208	1	000780912
1.5/8	225	1	000780914
1.13/16	243	1	000780916
2	254	1	000780918
2.3/16	264	1	000780920
2.3/8	275	1	000780922
★2.9/16	286	1	000780924
★2.15/16	311	1	000780926
★3.1/8	325	1	000780928
★3.1/2	355	1	000780930

89BA

chiavi poligonali semplici, antiscintilla



mm	L mm		
10	200	1	000890810
11	210	1	000890811
12	220	1	000890812
13	230	1	000890813
14	240	1	000890814
16	260	1	000890816
17	270	1	000890817
18	280	1	000890818
19	300	1	000890819
20	310	1	000890820
22	330	1	000890822
24	350	1	000890824
27	370	1	000890827
30	400	1	000890830
32	420	1	000890832

90BA

chiavi poligonali doppie antiscintilla



mm	L mm		
6x7	122	1	000900801
8x9	128	1	000900802
10x11	155	1	000900803
12x13	175	1	000900806
14x15	200	1	000900808
14x17	220	1	000900809
16x17	230	1	000900811
16x18	235	1	000900812
18x19	265	1	000900815
20x22	295	1	000900818
21x23	298	1	000900820
22x24	315	1	000900821
24x26	333	1	000900822
24x27	340	1	000900823
30x32	395	1	000900824
34x36	410	1	000900826
★36x41	450	1	000900828
★41x46	470	1	000900829
★46x50	490	1	000900830

91BA

chiavi poligonali curve antiscintilla



mm	Ø mm		
24	38	1	000910824
27	42	1	000910827
30	48	1	000910830
32	49	1	000910832
36	54	1	000910836
41	62	1	000910841
★46	69	1	000910846
★50	75	1	000910850
★55	82	1	000910855

92BA

leve di manovra per art. 91BA, antiscintilla



	L mm	91BA mm	Ø mm		
92BA/1	460	24÷30	25	1	000920810
92BA/2	610	32÷41	28	1	000920820
★92BA/3	760	46÷55	32	1	000920830

93BA

chiave a cricchetto per ponteggi antiscintilla



mm	L mm		
21x22	345	1	000930821

95BA

chiavi poligonali doppie dritte, antiscintilla



mm	L mm		
7x9	115	1	000950801
8x10	115	1	000950802
10x11	140	1	000950804
10x12	140	1	000950805
12x14	145	1	000950806
14x17	165	1	000950807
★16x18	170	1	000950809
★17x19	185	1	000950808
★18x19	185	1	000950810
★19x22	200	1	000950812
★21x23	230	1	000950815
★24x27	255	1	000950817
★30x32	295	1	000950820

96BA

chiavi maschio esagonale piegate antiscintilla

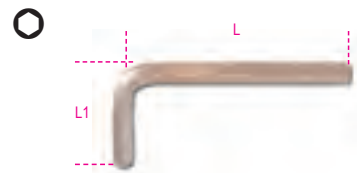

mm	L mm	L1 mm		
1,5	50	17	1	000960760
2	50	16	1	000960762
2,5	56	20	1	000960761
3	63	21	1	000960763
4	69	25	1	000960764
5	78	29	1	000960765
6	88	33	1	000960766
7	93	34	1	000960767
8	97	36	1	000960768
9	104	37	1	000960769
10	110	39	1	000960770
12	122	44	1	000960772

96BA/BP

chiavi maschio esagonale piegate con estremità sferica, antiscintilla



mm	L mm	L1 mm		
3	60	20	1	000961803
4	66	25	1	000961804
5	75	28	1	000961805
6	84	32	1	000961806
8	92	36	1	000961808
10	102	40	1	000961810
12	113	45	1	000961812

99BA

chiavi a settore articolate con nasello quadro antiscintilla per ghiere



mm	A mm		
32-75	4,0	1	000990803
50-120	4,5	1	000990805
115-170	4,5	1	000990811

110BA

chiavi regolabili a rullino, antiscintilla



L mm	A max		
100	13	1	001100810
150	18	1	001100815
200	24	1	001100820
250	32	1	001100825
300	39	1	001100830
375	48	1	001100837
★450	55	1	001100845
★600	65	1	001100860

330BA

tagliatubi per tubi gas,
antiscintilla



	Ø max	L mm	
330BA/2	50 mm	375	1 003300802
	2"		

363BA

giratubi modello americano,
antiscintilla



L mm	Ø max	Ø max mm	
150	1/2" gas	20	1 003630815
200	1" gas	30	1 003630820
250	1 1/2" gas	49	1 003630825
300	2" gas	60	1 003630830
350	2" gas	60	1 003630835
450	2 1/2" gas	76	1 003630845
600	3" gas	90	1 003630860

378BA

giratubi modello svedese,
antiscintilla



L mm	Ø max	
430	1" 1/2 gas	1 003780800
530	2" gas	1 003780801

386BA

giratubi reversibili a catena
modello pesante
antiscintilla



L mm	Ø max mm	L1 mm	
600	100	470	1 003860806
900	200	750	1 003860809

921BA

chiavi a bussola poligonali,
antiscintilla



Ø mm	Ø mm	L mm	
8	24,0	40	1 009210808
9	24,0	40	1 009210809
10	16,5	40	1 009210810
11	17,5	40	1 009210811

Ø mm	Ø mm	L mm	
12	18,5	40	1 009210812
13	19,5	40	1 009210813
14	20,0	40	1 009210814
15	21,5	40	1 009210815
16	24,0	40	1 009210816
17	25,0	40	1 009210817
18	25,0	40	1 009210818
19	28,0	42	1 009210819
20	29,0	42	1 009210820
21	30,0	43	1 009210821
22	30,5	43	1 009210822
24	34,0	43	1 009210824
25	36,0	43	1 009210825
26	37,5	43	1 009210826
27	37,5	45	1 009210827
28	38,9	46	1 009210828
30	41,5	46	1 009210830
32	43,5	46	1 009210832

921BA/21 - 921BA/22

prolunghe con attacchi quadri
maschio e femmina 1/2",
antiscintilla



	L mm	Ø mm	
921BA/21	125	30	1 009210842
921BA/22	250	31	1 009210844

921BA/25

snodo con attacchi quadri
maschio e femmina 1/2",
antiscintilla



L mm	Ø mm	1/2"	1/2"	
80	25			1 009210845

921BA/42

quadro maschio 1/2" con spina scorrevole,
antiscintilla



L mm		
250		1 009210846

921BA/50

cricchetto semplice
con quadro scorrevole 1/2",
antiscintilla



L mm	D mm	A mm	
250	45	16,5	1 009210850

921BA/R50

set di ricambio
antiscintilla



1/2"	1 009210851
------	-------------

926BA

chiavi a bussola poligonali,
antiscintilla



Ø mm	Ø mm	L mm	
24	40	55	1 009260824
26	40	55	1 009260826
27	40	55	1 009260827
28	41	55	1 009260828
30	43	60	1 009260830
32	45	60	1 009260832
34	48	60	1 009260834
36	50	60	1 009260836
38	53	60	1 009260838
41	57	65	1 009260841
46	63	65	1 009260846
50	68	70	1 009260850

926BA/22

prolunghe con attacchi quadri
maschio e femmina 3/4", antiscintilla



	L mm	Ø mm	
926BA/22	200	38	1 009260872

926BA/42

quadro maschio 3/4" con spina scorrevole,
antiscintilla



L mm		
400		1 009260876

926BA/50

cricchetto semplice con quadro
scorrevole 3/4",
antiscintilla



L mm	D mm	A mm	
300	61	22	1 009260880

926BA/R50

set di ricambio
antiscintilla

3/4"



3/4"

1 009260881

937BA

chiavi a pipa esagonali,
antiscintilla



mm	L mm	A mm	
13	240	45	1 009370813
17	260	51	1 009370817
19	270	55	1 009370819
22	278	59	1 009370822
24	286	63	1 009370824
27	294	69	1 009370827
30	302	75	1 009370830
32	310	81	1 009370832
*36	330	85	1 009370836
*41	350	90	1 009370841

961BA

leve scrostatore,
antiscintilla



L mm	A mm	
250	39	1 009610802
350	55	1 009610806

963BA

leve con estremità a punta e piatta curva,
antiscintilla



L mm	A mm	
500	24	1 009630801
*800	24	1 009630803
*1000	30	1 009630805

964BA

aprifusti antiscintilla



L mm		
385	1 009640801	

964BA/L

cesoia universale per fusti,
antiscintilla

Per l'apertura dei fusti metallici con bordo

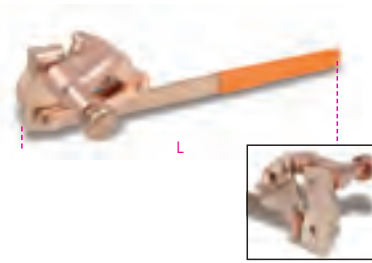

*964BA/L	L mm	
	510	1 009640821

965BA

chiavi di manovra semplici antiscintilla, per
valvole di sicurezza



A mm	A1 mm	L mm	
30	44	200	1 009650830
32	50	300	1 009650832
35	47	250	1 009650835
40	50	300	1 009650840
45	58	350	1 009650845
48	62	375	1 009650848
50	67	400	1 009650850
55	73	450	1 009650855
60	79	500	1 009650860
*65	82	550	1 009650865
*70	85	600	1 009650870

966BA

chiave di manovra antiscintilla,
per valvole di sicurezza

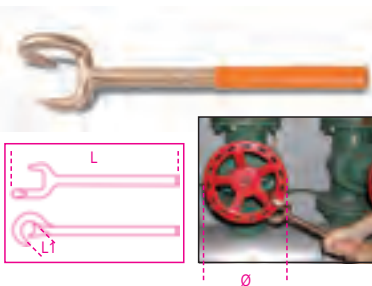

L mm	L1 mm	Ø min+max mm	
350	40	50+150	1 009660801

966BA/V

chiavi di manovra antiscintilla,
per valvole di sicurezza

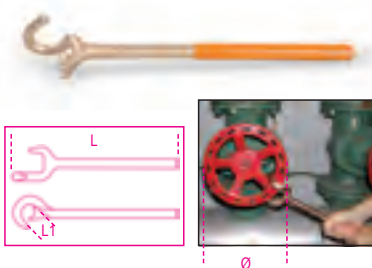

L mm	L1 mm	Ø min+max mm	
370	36	125+250	1 009660812
430	48	250+400	1 009660814

1032BA

pinze a becchi diritti antiscintilla
per anelli elastici di sicurezza, per fori
manici ricoperti in PVC



L mm	Ø mm	
200	40+100	1 010320820

1036BA

pinze a becchi diritti antiscintilla
per anelli elastici di sicurezza, per alberi
manici ricoperti in PVC



L mm	Ø mm	
200	40+100	1 010360820

1046BA

pinze regolabili
cerniera a cremagliera,
antiscintilla

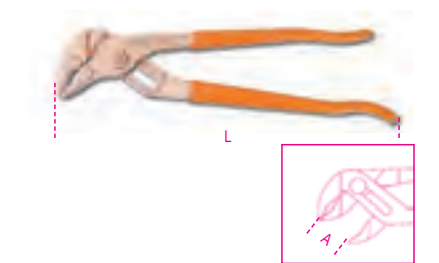

L mm	A max mm	
250	32	1 010460801
*300	52	1 010460803

1082BA

tronchese a taglienti diagonali,
antiscintilla



L mm	L1 mm	
160	22	1 010820801

1137BA

pinza da fochino,
antiscintilla



L mm	L1 mm	
185	30	1 011370801

1137BA/RC

lama di ricambio per 1137BA



1137BA/RC

1 011370851

1150BA

pinza universale,
antiscintilla



L mm
200

L1 mm
40

1 011500820

1162BA

pinza a becchi piatti lunghissimi
diritti zigrinati,
antiscintilla



L mm
150

L1 mm
54

1 011620815

1166BA

pinza a becchi mezzotondi
lunghissimi
diritti zigrinati,
antiscintilla



L mm
150

L1 mm
54

1 011660815

1270BA

giravite per viti a testa con intaglio,
antiscintilla



AxL mm mm
3x75 178
4x100 209
5x150 250
6x150 270
10x250 382
8x200 312

1 012700803
1 012700804
1 012700805
1 012700806
1 012700810
1 012700808

1272BA

giravite per viti
con impronta a croce Phillips®,
antiscintilla

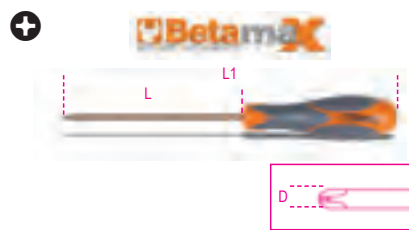

PHxDxL

L1

mm mm

1x5x100

209

1 012720801

2x6x150

270

1 012720802

3x8x200

332

1 012720803

1370BA

martelli tipo tedesco antiscintilla,
manico in legno



L1

L

g mm mm

500 108 310

1 013700805

1000 137 340

1 013700810

1370BA/MR

manici di ricambio per 1370BA

1370BA/MR500
1370BA/500
1370BA/MR1000
1370BA/1000

1 013700865

1 013700870

1375BA/PL

martello con penna sferica
a granchio antiscintilla,
manico in fibra



g L L1 Ø

mm mm mm mm

680 321 125 30

1 013750800

1377BA

martello con testa tonda e penna sferica
per caldaieri e lattonieri,
antiscintilla



g L1 L

mm mm mm

340 90 280

1 013770834

1377BA/PL

martello con testa tonda e penna sferica
per caldaieri e lattonieri, manico in fibra,
antiscintilla



g L1 L

mm mm mm

340 90 280

1 013770884

1379BA

martello scrostatore antiscintilla,
manico in legno



g L1 L

mm mm mm

500 142 315

1 013790850

1380BA

mazzette antiscintilla,
manico in legno



g L1 L

mm mm mm

1000 100 400

1 013800810

1500 118 400

1 013800815

2000 126 449

1 013800820

1380BA/MR

manici di ricambio per 1380BA

1380BA/MR1000
1380BA/1000
1380BA/MR1500
1380BA/1500
1380BA/MR2000
1380BA/2000

1 013800860

1 013800865

1 013800870

1 013800870

1381BA

mazze antiscintilla,
manico in legno



g L1 L

mm mm mm

5000 179 900

1 013810850

*8000 190 900

1 013810858

1381BA/MR

manico di ricambio per 1381BA

1381BA/MR5000 1381BA/5000	1 013810870
*1381BA/MR8000 1381BA/8000	1 013810878

1390BA

mazzuola con battenti in nylon,
antiscintilla



∅ mm	L mm	L1 mm	1 013900805
*52	370	130	

1390BA/R

battenti di ricambio in Nylon per 1390BA



D mm	4 013900885
52	

1602BA

pinza per capicorda
preisolati modello leggero,
antiscintilla



mm ²	L mm	1 016020801
0.75+6	200	

1701BA

scalpelli esagonale,
antiscintilla



L mm	A mm	S mm	1 017010810
150	12	10	
200	16	14	1 017010814
250	18	14	1 017010815
350	19	17	1 017010817

1703BA/A

ascia antiscintilla



L mm	L1 mm	A mm	1 017030082
340	145	82	

1703BA/P

piccone antiscintilla



A mm	L mm	L1 mm	1 017030150
56	1050	410	

1703BA/PL

badile antiscintilla

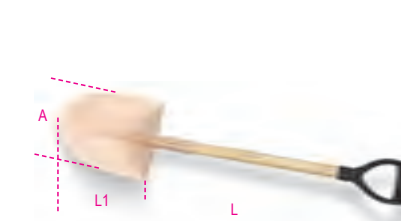

A mm	L1 mm	L mm	1 017030200
240	420	990	

1717BA

spatole rigide,
antiscintilla



A mm	1 017170801
60	
80	1 017170803

1717BA/1

raschiapareti antiscintilla



A mm	L mm	1 017170805
100	220	

1719BA8

lime da 8" antiscintilla



	L mm	1 017190801
1719BA8/P	200	
1719BA8/M	200	1 017190805
1719BA8/R	200	1 017190810
1719BA8/T	200	1 017190815
1719BA8/Q	200	1 017190820

1719BA12

lima da 12" antiscintilla



L mm	1 017190831
300	

1727BA

seghetto e lama,
antiscintilla

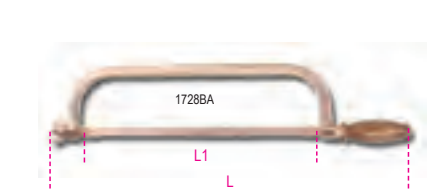

L mm	L1 mm	1 017270801
500	300	

1728BA

lama per segchetti,
antiscintilla



L mm	1 017280801
300	

1737BA

spazzola con fili antiscintilla



L mm	A mm	1 017370801
294	29	

1776BA

coltello antiscintilla



L1 mm	L mm	1 017760801
145	250	

1784BA

forbici antiscintilla



L mm	1 017840822
225	

PNEUMATICA

Da oltre 15 anni Beta Utensili ha ampliato la propria offerta con una gamma completa di utensili pneumatici e accessori destinati al mercato automotive e alla manutenzione industriale: avvitatori, cricchetti, trapani, smerigliatrici, levigatrici e molti altri articoli.

Nel corso di questo periodo la stretta collaborazione con gli utilizzatori professionisti è stata fondamentale per una crescita costante. E' grazie a questa crescita che oggi il mercato riconosce negli utensili pneumatici Beta un ottimo rapporto affidabilità/prestazioni.

Beta Utensili, con l'obiettivo di soddisfare al meglio le richieste del mercato, effettua le riparazioni degli articoli pneumatici all'interno del proprio Ufficio Qualità. Questo processo ha consentito all'azienda di incrementare notevolmente il proprio know-how e di essere sempre più reattiva nei confronti della clientela.

www.beta-tools.com



1921B1

baby cricchetto reversibile

1/4"

CE



Velocità libera	350 giri/min
Coppia massima	24 Nm
Capacità vite/dado	CI 8.8 M7 ● 11 mm
Capacità vite/dado	CI 12.9 M6 ● 10 mm
Attacco aria	1/4" GAS
Pressione di utilizzo	6,2 Bar
Ø interno tubo aria	8 mm
Consumo aria medio	68 l/min
Peso	0,4 kg

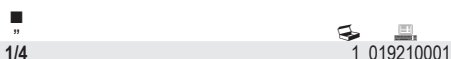

1921M1

cricchetto compatto reversibile

1/4"

CE



Velocità libera	200 giri/min
Coppia massima	27 Nm
Capacità vite/dado	CI 8.8 M7 ● 11 mm
Capacità vite/dado	CI 12.9 M6 ● 10 mm
Attacco aria	1/4" GAS
Pressione di utilizzo	6,2 Bar
Ø interno tubo aria	8 mm
Consumo aria medio	96 l/min
Peso	0,6 kg



1921M2

cricchetto compatto reversibile

3/8"

CE



Velocità libera	200 giri/min
Coppia massima	27 Nm
Capacità vite/dado	CI 8.8 M7 ● 11 mm
Capacità vite/dado	CI 12.9 M6 ● 10 mm
Attacco aria	1/4" GAS
Pressione di utilizzo	6,2 Bar
Ø interno tubo aria	8 mm
Consumo aria medio	96 l/min
Peso	0,6 kg



1921N3

cricchetto reversibile

1/2"

CE



Velocità libera	150 giri/min
Coppia massima	68 Nm
Capacità vite/dado	CI 8.8 M10 ● 16 mm
Capacità vite/dado	CI 12.9 M8 ● 13 mm
Attacco aria	1/4" GAS
Pressione di utilizzo	6,2 Bar
Ø interno tubo aria	10 mm
Consumo aria medio	140 l/min
Peso	1,2 kg

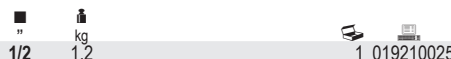

1921I

cricchetto reversibile a coppia elevata

1/2"

CE



Velocità libera	400 giri/min
Coppia massima	101 Nm
Capacità vite/dado	CI 8.8 M10 ● 16 mm
Capacità vite/dado	CI 12.9 M8 ● 13 mm
Attacco aria	1/4" GAS
Pressione di utilizzo	6,2 Bar
Ø interno tubo aria	10 mm
Consumo aria medio	235 l/min
Peso	1,3 kg



1924B

avvitatore reversibile compatto

• Meccanismo impulsivo "Pin Clutch"

3/8"

CE



Velocità libera	10.000 giri/min
Coppia massima	353 Nm
Capacità vite/dado	CI 8.8 M16 ● 24 mm
Capacità vite/dado	CI 12.9 M14 ● 21 mm
Attacco aria	1/4" GAS
Pressione di utilizzo	6,2 Bar
Ø interno tubo aria	8 mm
Consumo aria medio	80 l/min
Peso	1,5 kg



1924CD

avvitatore reversibile in materiale composito

• Meccanismo impulsivo doppio martello

3/8"

CE



Velocità libera	10.000 giri/min
Coppia massima	410 Nm
Capacità vite/dado	CI 8.8 M16 ● 24 mm
Capacità vite/dado	CI 12.9 M14 ● 21 mm
Attacco aria	1/4" GAS
Pressione di utilizzo	6,2 Bar
Ø interno tubo aria	8 mm
Consumo aria medio	79 l/min
Peso	1,3 kg



Beta

1927CD

avvitatore reversibile in materiale composito

- Meccanismo impulsivo doppio martello



Velocità libera	7.000 giri/min
Coppia massima	1.020 Nm
Capacità vite/dado	CI 8.8 M22●34 mm
Capacità vite/dado	CI 12.9 M18●27 mm
Attacco aria	1/4" GAS
Pressione di utilizzo	6,2 Bar
Ø interno tubo aria	10 mm
Consumo aria medio	130 l/min
Peso	1,9 kg

1/2	kg	1,9	1	019270007
-----	----	-----	---	-----------

1927P

avvitatore reversibile in materiale composito

- Meccanismo impulsivo doppio martello



Velocità libera	7.500 giri/min
Coppia massima	1.750 Nm
Capacità vite/dado	CI 8.8 M24●36 mm
Capacità vite/dado	CI 12.9 M20●30 mm
Attacco aria	1/4" GAS
Pressione di utilizzo	6,2 Bar
Ø interno tubo aria	10 mm
Consumo aria medio	290 l/min
Peso	2 kg

1/2	kg	2,0	1	019270008
-----	----	-----	---	-----------

1927XM

avvitatore reversibile compatto

- Meccanismo impulsivo singolo martello



Velocità libera	10.000 giri/min
Coppia massima	770 Nm
Capacità vite/dado	CI 8.8 M22●34 mm
Capacità vite/dado	CI 12.9 M18●27 mm
Attacco aria	1/4" GAS
Pressione di utilizzo	6,2 Bar
Ø interno tubo aria	10 mm
Consumo aria medio	122 l/min
Peso	1,3 kg

1/2	kg	1,3	1	019270030
-----	----	-----	---	-----------

1927A

avvitatore reversibile

- Meccanismo impulsivo "Pin Clutch"



Velocità libera	7.000 giri/min
Coppia massima	610 Nm
Capacità vite/dado	CI 8.8 M22●34 mm
Capacità vite/dado	CI 12.9 M18●27 mm
Attacco aria	1/4" GAS
Pressione di utilizzo	6,2 Bar
Ø interno tubo aria	10 mm
Consumo aria medio	160 l/min
Peso	2,7 kg

1/2	kg	2,7	1	019270002
-----	----	-----	---	-----------

1927AN

avvitatore reversibile angolare

- Meccanismo impulsivo singolo martello



Velocità libera	4.700 giri/min
Coppia massima	244 Nm
Capacità vite/dado	CI 8.8 M14●21 mm
Capacità vite/dado	CI 12.9 M12●19 mm
Attacco aria	1/4" GAS
Pressione di utilizzo	6,2 Bar
Ø interno tubo aria	10 mm
Consumo aria medio	190 l/min
Peso	2,1 kg

1/2	kg	2,1	1	019270012
-----	----	-----	---	-----------

1927SP-AM

supporto magnetico per avvitatore pneumatico

- Dotato di due magneti ad alta tenuta con gomma protettiva
- Permette di alloggiare 1 avvitatore da 1/2", 4 bussole e 1 chiave dinamometrica
- Portata: 10 kg



g	400	1	019270000
---	-----	---	-----------

Beta

1928CD

avvitatore reversibile in materiale composito

- Meccanismo impulsivo doppio martello



Velocità libera	4.500 giri/min
Coppia massima	1.800 Nm
Capacità vite/dado	Cl 8.8 M27 ● 41 mm
Capacità vite/dado	Cl 12.9 M24 ● 36 mm
Attacco aria	3/8" GAS
Pressione di utilizzo	6,2 Bar
Ø interno tubo aria	10 mm
Consumo aria medio	215 l/min
Peso	3,5 kg



1928DAL

avvitatore reversibile

- Meccanismo impulsivo doppio martello

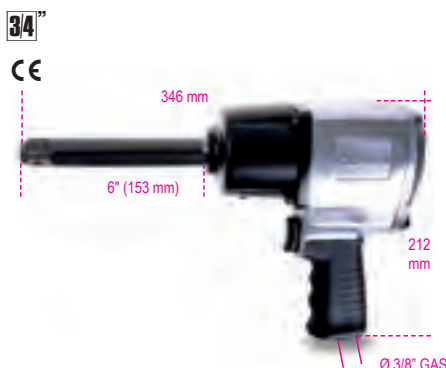

Velocità libera	5.000 giri/min
Coppia massima	1.695 Nm
Capacità vite/dado	Cl 8.8 M27 ● 41 mm
Capacità vite/dado	Cl 12.9 M24 ● 36 mm
Attacco aria	3/8" GAS
Pressione di utilizzo	6,2 Bar
Ø interno tubo aria	10 mm
Consumo aria medio	240 l/min
Peso	4,8 kg



1930CD

avvitatore reversibile in materiale composito

- Meccanismo impulsivo doppio martello



Velocità libera	4.000 giri/min
Coppia massima	2.445 Nm
Capacità vite/dado	Cl 8.8 M36 ● 55 mm
Capacità vite/dado	Cl 12.9 M30 ● 46 mm
Attacco aria	1/2" GAS
Pressione di utilizzo	6,2 Bar
Ø interno tubo aria	13 mm
Consumo aria medio	320 l/min
Peso	7,1 kg



1928DA

avvitatore reversibile

- Meccanismo impulsivo doppio martello



Velocità libera	5.000 giri/min
Coppia massima	1.695 Nm
Capacità vite/dado	Cl 8.8 M27 ● 41 mm
Capacità vite/dado	Cl 12.9 M24 ● 36 mm
Attacco aria	3/8" GAS
Pressione di utilizzo	6,2 Bar
Ø interno tubo aria	10 mm
Consumo aria medio	240 l/min
Peso	4,3 kg

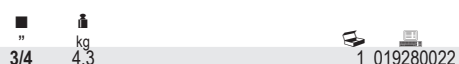

1928K4

assortimento di un avvitatore reversibile e quattro bussole Macchina serie lunga

- Meccanismo impulsivo "Pin Clutch"



Velocità libera	4.000 giri/min
Coppia massima	1.493 Nm
Capacità vite/dado	Cl 8.8 M27 ● 41 mm
Capacità vite/dado	Cl 12.9 M24 ● 36 mm
Attacco aria	3/8" GAS
Pressione di utilizzo	6,2 Bar
Ø interno tubo aria	10 mm
Consumo aria medio	260 l/min
Peso avvitatore	5,2 kg
Peso kit	9,3 kg

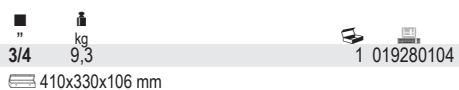

1930NCD

avvitatore reversibile in materiale composito

- Meccanismo impulsivo doppio martello



Velocità libera	4.000 giri/min
Coppia massima	2.445 Nm
Capacità vite/dado	Cl 8.8 M36 ● 55 mm
Capacità vite/dado	Cl 12.9 M30 ● 46 mm
Attacco aria	1/2" GAS
Pressione di utilizzo	6,2 Bar
Ø interno tubo aria	13 mm
Consumo aria medio	320 l/min
Peso	8,8 kg



1930PA

avvitatore reversibile

• Meccanismo impulsivo doppio martello



Velocità libera	3.500 giri/min
Coppia massima	2.445 Nm
Capacità vite/dado	Cl 8.8 M36●55 mm
Capacità vite/dado	Cl 12.9 M30●46 mm
Attacco aria	1/2" GAS
Pressione di utilizzo	6,2 Bar
Ø interno tubo aria	13 mm
Consumo aria medio	350 l/min
Peso	9,6 kg

■	kg	1	9,6	1	019300032
---	----	---	-----	---	-----------

1930LA

avvitatore reversibile

• Meccanismo impulsivo doppio martello

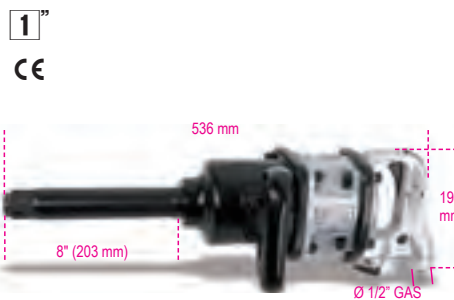

Velocità libera	4.000 giri/min
Coppia massima	2.445 Nm
Capacità vite/dado	Cl 8.8 M36●55 mm
Capacità vite/dado	Cl 12.9 M30●46 mm
Attacco aria	1/2" GAS
Pressione di utilizzo	6,2 Bar
Ø interno tubo aria	13 mm
Consumo aria medio	460 l/min
Peso	10,6 kg

■	kg	1	10,6	1	019300037
---	----	---	------	---	-----------

1930A

avvitatore reversibile

• Meccanismo impulsivo doppio martello



Velocità libera	4.000 giri/min
Coppia massima	2.445 Nm
Capacità vite/dado	Cl 8.8 M36●55 mm
Capacità vite/dado	Cl 12.9 M30●46 mm
Attacco aria	1/2" GAS
Pressione di utilizzo	6,2 Bar
Ø interno tubo aria	13 mm
Consumo aria medio	460 l/min
Peso	9,5 kg

■	kg	1	9,5	1	019300036
---	----	---	-----	---	-----------

1930HLA

avvitatore reversibile

• Meccanismo impulsivo doppio martello



Velocità libera	3.000 giri/min
Coppia massima	3.661 Nm
Capacità vite/dado	Cl 8.8 M42●65 mm
Capacità vite/dado	Cl 12.9 M33●50 mm
Attacco aria	1/2" GAS
Pressione di utilizzo	6,2 Bar
Ø interno tubo aria	13 mm
Consumo aria medio	460 l/min
Peso	16,4 kg

■	kg	1	16,4	1	019300040
---	----	---	------	---	-----------

1930ZL

avvitatore reversibile

• Meccanismo impulsivo doppio martello



Velocità libera	3.000 giri/min
Coppia massima	4.068 Nm
Capacità vite/dado	Cl 8.8 M42●65 mm
Capacità vite/dado	Cl 12.9 M36●55 mm
Attacco aria	1/2" GAS
Pressione di utilizzo	6,2 Bar
Ø interno tubo aria	13 mm
Consumo aria medio	480 l/min
Peso	15 kg

■	kg	1	15	1	019300070
---	----	---	----	---	-----------

1931CD6

trapano reversibile in composito



Velocità libera	2.600 giri/min
Capacità mandrino	1÷6 mm
Potenza	0,23 kW
Filettatura albero	3/8" - 24UNF
Attacco aria	1/4" GAS
Pressione di utilizzo	6,2 Bar
Ø interno tubo aria	8 mm
Consumo aria medio	130 l/min
Peso	0,6 kg

■	kg	0,6	1	019310006
---	----	-----	---	-----------

1931CD10

trapano reversibile in composito



Velocità libera	1.800 giri/min
Capacità mandrino	1÷10 mm
Potenza	0,38 kW
Filettatura albero	3/8" - 24UNF
Attacco aria	1/4" GAS
Pressione di utilizzo	6,2 Bar
Ø interno tubo aria	10 mm
Consumo aria medio	170 l/min
Peso	1,0 kg

kg
1,0

1 019310010

1931CD13

trapano reversibile in composito



Velocità libera	800 giri/min
Capacità mandrino	1,5÷13 mm
Potenza	0,38 kW
Filettatura albero	1/2" - 20UNC
Attacco aria	1/4" GAS
Pressione di utilizzo	6,2 Bar
Ø interno tubo aria	10 mm
Consumo aria medio	170 l/min
Peso	1,3 kg

kg
1,3

1 019310013

1931AN10

trapano angolare reversibile



Velocità libera	1.400 giri/min
Capacità mandrino	1÷10 mm
Potenza	0,38 kW
Filettatura albero	3/8" - 24UNF
Attacco aria	1/4" GAS
Pressione di utilizzo	6,2 Bar
Ø interno tubo aria	10 mm
Consumo aria medio	150 l/min
Peso	1,1 kg

kg
1,1

1 019310030

1932B10

trapano reversibile



Velocità libera	1.800 giri/min
Capacità mandrino	1÷10 mm
Potenza	0,23 kW
Filettatura albero	3/8" - 24UNF
Attacco aria	1/4" GAS
Pressione di utilizzo	6,2 Bar
Ø interno tubo aria	10 mm
Consumo aria medio	160 l/min
Peso	1,2 kg

kg
1,2

1 019320040

1932RS13

trapano reversibile



Velocità libera	750 giri/min
Capacità mandrino	1,5÷13 mm
Potenza	0,23 kW
Filettatura albero	3/8" - 24UNF
Attacco aria	1/4" GAS
Pressione di utilizzo	6,2 Bar
Ø interno tubo aria	10 mm
Consumo aria medio	160 l/min
Peso	1,4 kg

kg
1,4

1 019320043

1932B13

trapano reversibile



Velocità libera	400 giri/min
Capacità mandrino	1,5÷13 mm
Potenza	0,34 kW
Filettatura albero	1/2" - 20UNC
Attacco aria	1/4" GAS
Pressione di utilizzo	6,2 Bar
Ø interno tubo aria	10 mm
Consumo aria medio	180 l/min
Peso	1,6 kg

kg
1,6

1 019320004

1933

smerigliatrice assiale

CE



Velocità libera	25.000 giri/min
Capacità pinza	3 - 6 mm
Potenza	0,20 kW
Attacco aria	1/4" GAS
Pressione di utilizzo	6,2 Bar
Ø interno tubo aria	10 mm
Consumo aria medio	230 l/min
Peso	380 g

g 380 1 019330001

1933I

smerigliatrice assiale

CE



Velocità libera	20.000 giri/min
Capacità pinza	3 - 6 mm
Potenza	0,38 kW
Attacco aria	1/4" GAS
Pressione di utilizzo	6,2 Bar
Ø interno tubo aria	10 mm
Consumo aria medio	260 l/min
Peso	670 g

g 670 1 019330005

1933L

smerigliatrice assiale con albero prolungato

CE



Velocità libera	25.000 giri/min
Capacità pinza	3 - 6 mm
Potenza	0,20 kW
Attacco aria	1/4" GAS
Pressione di utilizzo	6,2 Bar
Ø interno tubo aria	10 mm
Consumo aria medio	270 l/min
Peso	670 g

g 670 1 019330015

1933IL

smerigliatrice assiale con albero prolungato

CE



Velocità libera	20.000 giri/min
Capacità pinza	3 - 6 mm
Potenza	0,38 kW
Attacco aria	1/4" GAS
Pressione di utilizzo	6,2 Bar
Ø interno tubo aria	10 mm
Consumo aria medio	113 l/min
Peso	1,4 kg

kg 1,4 1 019330010

1933AN90

smerigliatrice angolare

CE



Velocità libera	20.000 giri/min
Capacità pinza	3 - 6 mm
Potenza	0,20 kW
Attacco aria	1/4" GAS
Pressione di utilizzo	6,2 Bar
Ø interno tubo aria	10 mm
Consumo aria medio	230 l/min
Peso	510 g

g 510 1 019330020

1934BV

pulitrice a basse velocità

CE



Velocità libera	3.700 giri/min
Capacità pinza	3 - 6 mm
Potenza	0,37 kW
Attacco aria	1/4" GAS
Pressione di utilizzo	6,2 Bar
Ø interno tubo aria	10 mm
Consumo aria medio	113 l/min
Peso	840 g

g 840 1 019340000

1934MAV

microsmerigliatrice assiale

CE



Velocità libera	56.000 giri/min
Capacità pinza	3 mm
Potenza	0,04 kW
Attacco aria	1/4" GAS
Pressione di utilizzo	6,2 Bar
Ø interno tubo aria	4,5 mm
Consumo aria medio	115 l/min
Peso	205 g

g 205 1 019340010

1934MAV70

microsmerigliatrice assiale ad alta velocità

CE



Velocità libera	70.000 giri/min
Capacità pinza	3 mm
Potenza	0,08 kW
Attacco aria	1/4" GAS
Pressione di utilizzo	6,2 Bar
Ø interno tubo aria	4,5 mm
Consumo aria medio	115 l/min
Peso	210 g

g 210 1 019340030

1935F

giravite reversibile

1/4"

CE



Velocità libera	800 giri/min
Campo di coppia	16 Nm
Capacità vite	6-9 M
Porta inserti	● 1/4"
Attacco aria	1/4" GAS
Pressione di utilizzo	6,2 Bar
Ø interno tubo aria	10 mm
Consumo aria medio	150 l/min
Peso	1,3 kg

kg
1,3

1 019350045

1936/4A

smerigliatrice angolare

CE



Velocità libera	11.000 giri/min
Dimensione mola	115 mm
Potenza	0,66 kW
Filettatura albero	M14
Attacco aria	1/4" GAS
Pressione di utilizzo	6,2 Bar
Ø interno tubo aria	10 mm
Consumo aria medio	390 l/min
Peso	1,8 kg

kg
1,8

1 019360024

1936/5A

smerigliatrice angolare

CE



Velocità libera	10.000 giri/min
Dimensione mola	125 mm
Potenza	0,66 kW
Filettatura albero	M14
Attacco aria	1/4" GAS
Pressione di utilizzo	6,2 Bar
Ø interno tubo aria	10 mm
Consumo aria medio	390 l/min
Peso	1,9 kg

kg
1,9

1 019360025

1936/5

smerigliatrice angolare

CE



Velocità libera	10.500 giri/min
Dimensione mola	125 mm
Potenza	0,7 kW
Filettatura albero	M14
Attacco aria	1/4" GAS
Pressione di utilizzo	6,2 Bar
Ø interno tubo aria	10 mm
Consumo aria medio	380 l/min
Peso	2,0 kg

kg
2,0

1 019360005

1936/7

smerigliatrice angolare

CE



Velocità libera	7000 giri/min
Dimensione mola	178 mm
Potenza	1,4 kW
Filettatura albero	M14
Attacco aria	3/8" GAS
Pressione di utilizzo	6,2 Bar
Ø interno tubo aria	13 mm
Consumo aria medio	500 l/min
Peso	3,6 kg

kg
3,6

1 019360007

1937

levigatrice rotorbitale palmare senza lubrificazione, in composito

• Diametro orbita 5 mm

CE



Velocità libera	12.000 giri/min
Potenza	0,18 kW
Dimensione platorello	150 mm
Diametro orbita	5 mm
Filettatura albero	5/16"-24
Attacco aria	1/4" GAS
Pressione di utilizzo	6,2 Bar
Ø interno tubo aria	10 mm
Consumo aria medio	170 l/min
Peso	860 g

g
860

1 019370001

1937R/P

platorello Ø 150 mm 6 fori per 1937



1937R/P

1 019370002

Beta

1937/KL

mini lucidatrice orbitale

- Platorello di levigatura Ø 75 mm
- 2 spugne di lucidatura Ø 90 mm - 1937/KL-DSB, 1937/KL-DSG
- Lana d'agnello Ø 90 mm - 1937/KL-DLA



Velocità libera	3.200 giri/min
Potenza	0,25 kW
Dimensione platorello	75 mm
Filettatura albero	M6
Attacco aria	1/4" GAS
Pressione di utilizzo	6,2 Bar
Ø interno tubo aria	10 mm
Consumo aria medio	91 l/min
Peso lucidatrice	0,75 kg
Peso kit	1,8 kg

kg	1,8	1	019370161
----	-----	---	-----------

1937/KL-D

accessori per 1937/KL

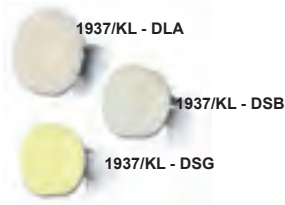

	D mm		
1937/KL-DLA	90	1	019370164
1937/KL-DSB	90	1	019370165
1937/KL-DSG	90	1	019370166

1937M

levigatrice multifunzione
con 16 accessori



Velocità libera	3.500 giri/min
Potenza	0,34 kW
Attacco aria	1/4" GAS
Pressione di utilizzo	6,2 Bar
Ø interno tubo aria	10 mm
Consumo aria medio	113 l/min
Peso levigatrice	1,5 kg
Peso kit	4,5 kg

kg	4,5	1	019370011
----	-----	---	-----------

458x495x116 mm

1937M-01÷11

accessori per 1937M



	L mm	1937M-		
1937M-01	30		1	019370101
1937M-02	30		1	019370102
1937M-03	11		1	019370103
1937M-04	23		1	019370104
1937M-05	11		1	019370105
1937M-06	23		1	019370106
* 1937M-07	16		1	019370107
1937M-08	13	07	1	019370108
1937M-09	26	07	1	019370109
1937M-10	11	03, 05	1	019370110
1937M-11	23	01, 02, 04, 06	1	019370111

* I prezzi indicati sono relativi a 6 pezzi

1937N10

levigatrice a nastro



Velocità libera	20.000 giri/min
Potenza	0,37 kW
Dimensioni nastro	10x330 mm
Attacco aria	1/4" GAS
Pressione di utilizzo	6,2 Bar
Ø interno tubo aria	10 mm
Consumo aria medio	374 l/min
Peso	0,9 kg

kg	0,9	1	019370041
----	-----	---	-----------

1937N10-GR

nastri abrasivi per 1937N10



	P		
1937N10-GR60	60	1	019370146
1937N10-GR80	80	1	019370148
1937N10-GR100	100	1	019370150
1937N10-GR120	120	1	019370152

I prezzi indicati sono relativi a 10 pezzi

1937N20

levigatrice a nastro



Velocità libera	16.000 giri/min
Potenza	0,45 kW
Dimensioni nastro	20x520 mm
Attacco aria	1/4" GAS
Pressione di utilizzo	6,2 Bar
Ø interno tubo aria	10 mm
Consumo aria medio	400 l/min
Peso	1,6 kg

kg	1,6	1	019370051
----	-----	---	-----------

1937N20-GR

nastri abrasivi per 1937N20



	P		
1937N20-GR60	60	1	019370156
1937N20-GR80	80	1	019370158
1937N20-GR100	100	1	019370160
1937N20-GR120	120	1	019370162

I prezzi indicati sono relativi a 10 pezzi

1938

staccavetri

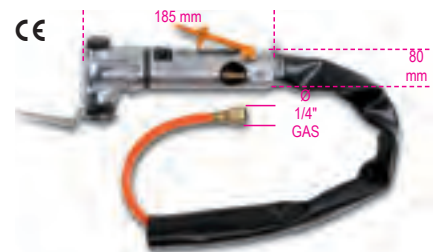

Oscillazioni al minuto	20.000
Attacco aria	1/4" GAS
Pressione di utilizzo	6,2 Bar
Ø interno tubo aria	6,5 mm
Consumo aria medio	200 l/min
Peso	1,0 kg

kg	1,0	1	019380021
----	-----	---	-----------

1938R/L

lame per staccavetri

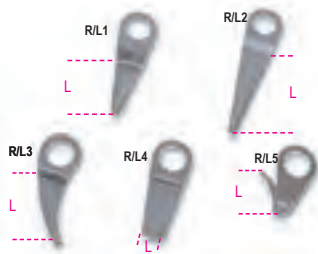

	L mm		
1938R/L1	57	1	019380041
1938R/L2	90	1	019380042
1938R/L3	50	1	019380043
1938R/L4	16	1	019380044
1938R/L5	36	1	019380045

1938R/S5

serie di 5 lame per staccavetri 1938

1938R/S5	1	019380055
----------	---	-----------

1940

martello scalpellatore



Colpi al minuto	3.500
Dimensione attacco	□ 11 mm
Dimensione pistone	19 mm
Corsa del pistone	67 mm
Attacco aria	1/4" GAS
Pressione di utilizzo	6,2 Bar
Ø interno tubo aria	8 mm
Consumo aria medio	240 l/min
Peso	1,9 kg

kg	1,9	1	019400001
----	-----	---	-----------

1940MT

molla di tenuta per 1940



1940MT	5	019400110
--------	---	-----------

1940S...

scalpelli per martelli scalpellatori 1940



1940SN	5	019400020
1940ST	5	019400021
1940SD	5	019400022
1940SPS	5	019400023
1940SDT	5	019400024

1940/S5

serie di 5 scalpelli per martelli scalpellatori 1940



1940/S5	1	019400030
---------	---	-----------

1940E10

martello scalpellatore

• Compatibile con scalpelli con attacco esagonale da 10mm



Colpi al minuto	2.900
Dimensione attacco	□ 10 mm
Dimensione pistone	19 mm
Corsa del pistone	67 mm
Attacco aria	1/4" GAS
Pressione di utilizzo	6,2 Bar
Ø interno tubo aria	10 mm
Consumo aria medio	76 l/min
Peso	1,7 kg

kg	1,7	1	019400010
----	-----	---	-----------

1940E10/MT

molla di tenuta per 1940E10



1940E10/MT	5	019400112
------------	---	-----------

1940E10/S...

scalpelli per martelli scalpellatori 1940E10

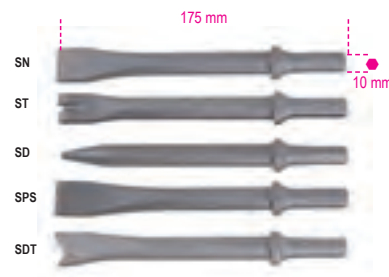

1940E10/SN	5	019400040
1940E10/ST	5	019400041
1940E10/SD	5	019400042
1940E10/SPS	5	019400043
1940E10/SDT	5	019400044

1940E10/S5

serie di 5 scalpelli per martelli scalpellatori 1940E10



1940E10/S5	1	019400050
------------	---	-----------

1942A

seghetto alternativo



Corse al minuto	10.000
Lunghezza della corsa	10 mm
Attacco aria	1/4" GAS
Pressione di utilizzo	6,2 Bar
Ø interno tubo aria	8 mm
Consumo aria medio	75 l/min
Peso	550 g

g	550	1	019420000
---	-----	---	-----------

1942LR

lame Bimetal per seghetto alternativo 1942A



1942LR	5	019420032
--------	---	-----------

1944

scrostatore ad aghi

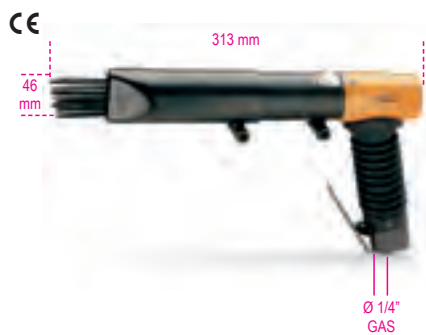

Colpi al minuto	3.000
Corsa del pistone	33 mm
N. aghi	19
Ø aghi	3 mm
Attacco aria	1/4" GAS
Pressione di utilizzo	6,2 Bar
Ø interno tubo aria	8 mm
Consumo aria medio	140 l/min
Peso	2,6 kg

kg 2,6 1 019440001

1944AR

set di 19 aghi per raschietto 1944



1944AR 1 019440005

1946

rivettatrice

• fornita con ugelli intercambiabili da 2,4 - 3,2 - 4,0 - 4,8 mm



Potenza di trazione	8.000 N
Lunghezza della corsa	14 mm
Capacità massima rivetti	Ø alluminio 4,8 mm
Attacco aria	1/4" GAS
Pressione di utilizzo	6,2 Bar
Ø interno tubo aria	6 mm
Consumo aria	1,2 l/ciclo
Peso	1,5 kg

kg 1,5 1 019460001

1946C4,8

rivettatrice

• Con aspirazione automatica
• Fornita assemblata per rivetti in acciaio, acciaio inox, alluminio e rame, da 2,4 - 3,2 - 4,0 - 4,8 mm



Potenza di trazione	8.900 N
Lunghezza della corsa	15 mm
Capacità massima rivetti	Ø acciaio inox 4,8 mm
Attacco aria	1/4" GAS
Pressione di utilizzo	6,2 Bar
Ø interno tubo aria	10 mm
Consumo aria	2,6 l/ciclo
Peso	1,5 kg

kg 1,5 1 019460006

1946C7,8

rivettatrice

• Con aspirazione automatica
• Fornita assemblata per rivetti in acciaio, acciaio inox, alluminio e rame, da 4,8 - 5,6 - 6,4 - 7,8 mm



Potenza di trazione	16.900 N
Lunghezza della corsa	22,5 mm
Capacità massima rivetti	Ø acciaio inox 7,8 mm
Attacco aria	1/4" GAS
Pressione di utilizzo	6,2 Bar
Ø interno tubo aria	10 mm
Consumo aria	4,9 l/ciclo
Peso	1,8 kg

kg 1,8 1 019460008



1946KF

rivettatrice per inserti filettati

• fornita assemblata per rivetti filettati in acciaio, acciaio inox, alluminio e rame, M4, M5, M6, M8



Potenza di trazione	14.235 N
Lunghezza della corsa	7 mm
Capacità massima rivetti	Ø acciaio inox M8
Attacco aria	1/4" GAS
Pressione di utilizzo	6,2 Bar
Ø interno tubo aria	10 mm
Consumo aria	2,1 l/ciclo
Peso rivettatrice	2,1 kg
Peso kit	3,4 kg

kg 3,4 1 019460012

1946KF/M...

perni di ricambio per 1946KF



1946KF/M4	1 019460124
1946KF/M5	1 019460125
1946KF/M6	1 019460126
1946KF/M8	1 019460128

1947

pistola per sigillanti



Dimensione del tubo	210x50 mm
Capacità della cartuccia	350 ml
Attacco aria	1/4" GAS
Pressione di utilizzo	4,8 Bar
Ø interno tubo aria	10 mm
Consumo aria medio	120 l/min
Peso	1,1 kg

kg 1,1 1 019470001

1947H

pistola per sigillanti



Dimensione del tubo	210x50 mm
Capacità della cartuccia	300/310 ml
Attacco aria	1/4" GAS
Pressione di utilizzo	4 ÷ 8 Bar
Ø interno tubo aria	2,5 mm
Consumo aria medio	120 l/min
Peso	750 g

750 g 1 019470011

1948

penna per incisioni



Colpi al minuto	3.500 ÷ 3.800
Durezza massima	60 HRC
Attacco aria	1/4" GAS
Pressione di utilizzo	6,2 Bar
Consumo aria medio	50 l/min
Peso	150 g

150 g 1 019480001

1948PR

punta in carburo di tungsteno di ricambio per 1948

- durezza massima: 60 HRC



1948PR 1 019480005

1949BC

pistola di soffiaggio progressiva con ugello in gomma

- Corpo in materiale composito ad alta resistenza, antiurto
- Ugello in gomma antigraffio sostituibile
- Dotato di innesto



Inserto alluminio filettato	1/4" GAS
Pressione di utilizzo	6-8 Bar
Pressione massima di utilizzo	15 Bar
Consumo aria medio	87 l/min
Temperatura di utilizzo	-20°C ÷ 70°C
Peso	120 g

120 g 1 019490022

1949BC/RU

5 ugelli in gomma per 1949BC



1949BC/RU 1 019490122

1949T

pistola di soffiaggio progressiva telescopica

- Corpo in materiale composito ad alta resistenza, antiurto
- Tubo telescopico in acciaio orientabile: 165 mm ÷ 300 mm
- Dotato di innesto



Inserto in alluminio filettato	1/4" GAS
Pressione di utilizzo	6+8 Bar
Pressione massima di utilizzo	15 Bar
Consumo aria medio	144 l/min
Temperatura di utilizzo	-20°C ÷ 70°C
Peso	190 g

190 g 1 019490040

1949F

pistola di soffiaggio progressiva

- In composito di materiale plastico ad alta resistenza, antiurto, antigraffio e termicamente isolato
- La speciale valvola e la sensibilità della leva consentono la progressiva apertura del circuito, ottimizzando il flusso dell'aria



Inserto ottone filettato	1/4" GAS
Pressione di utilizzo	6-8 Bar
Pressione massima di utilizzo	10 Bar
Temperatura di utilizzo	-15°C ÷ 70°C
Peso	130 g

130 g 5 019490027

1949G

pistola di soffiaggio progressiva con regolatore d'aria

- In composito di materiale plastico ad alta resistenza, antiurto, antigraffio e termicamente isolato
- La speciale valvola e la sensibilità della leva consentono la progressiva apertura del circuito, ottimizzando il flusso dell'aria



Inserto ottone filettato	1/4" GAS
Pressione di utilizzo	6-8 Bar
Pressione massima di utilizzo	10 Bar
Temperatura d'utilizzo	-15 °C ÷ 70 °C
Peso	140 g

140 g 5 019490035



1949DGT

pistola digitale per gonfiaggio pneumatici

- Pressione di esercizio: 0÷11 bar (2.0÷160 psi)
- 4 unità di misura: psi/bar/kgcm2/kpa
- Display LCD retroilluminato
- Funzione reset
- Autospegnimento dopo 3 min.
- Pulsante di scarico pressione
- Risoluzione: 0,05 bar
- Corpo in abs, guscio protettivo in gomma sul manometro, impugnatura antiurto e antiscivolo
- Alimentazione: 2 batterie 1,5V tipo AAA
- Compatibile con l'innesto 1916G 1/4"



1949DGT	bar	g	
	0÷11	500	1 019490020

1949GPE

pistola per gonfiaggio pneumatici

- Pressione di esercizio: 0÷11 bar (10÷160 psi)
- Funzione di scarico pressione
- Funzione di solo misurazione della pressione
- Manometro rivestito in gomma antiurto
- Rotazione del tubo a 360°



1949GPE	bar	g	
	0÷11	640	1 019490008

1949GPN

pistola per gonfiaggio pneumatici
corpo in ABS

- manometro certificato CE con scala 0,7÷12 Bar (ripartizione in 1/10 Bar)
- 2 pulsanti servoassistiti consentono il gonfiaggio (+) e lo sgonfiaggio (-) del pneumatico con precisione e rapidità
- fornita con certificato di taratura
- fornita con guscio di protezione antiurto e occhio per aggancio
- fornita con raccordo filettato 1/4" GAS
- attacco aria girevole per tubo in gomma Ø7 mm



1949GPN	bar	g	
	0,7÷12	810	1 019490011

1949M

misuratore di pressione per pneumatici



1949M	bar	psi	g	
	0÷4	5÷60	280	1 019490400

1951

pistola di lavaggio

- indicata per la pulizia di tappezzeria auto, moquette, sedili e bagagliai



Velocità libera	3.600 giri/min
Capacità serbatoio	1000 ml
Attacco aria	1/4" GAS
Pressione di utilizzo	6,2 Bar
Ø interno tubo aria	8 mm
Consumo aria medio	110 l/min
Peso	650 g

1951	g	
	650	1 019510051

1901BM/8

avvolgitubo automatico
corpo in materiale plastico antiurto
per aria compressa o acqua fredda

- Pressione di utilizzo massima 12 Bar

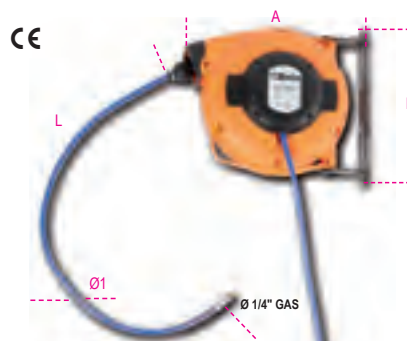

1901BM/8	Ø1	L	A	B	
	8	9+1	370	305	1 019010111

1901T/10

avvolgitubo automatico
corpo in materiale plastico antiurto
per aria compressa o acqua fredda

- Pressione di utilizzo massima 15 Bar

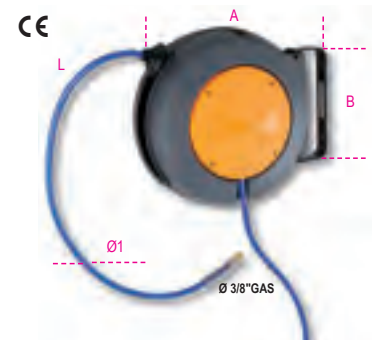

1901T/10	Ø1	L	A	B	
	10	15+1	445	160	1 019010210

1910/8 - 1910/10

avvolgitubo automatico
corpo in alluminio
per aria compressa o acqua fredda

- pressione di utilizzo massima 15 Bar



1910/8	Ø1	L	A	B	Ø2	
	8	9+1	375	130	1/4" GAS	1 019100008

1910/10	Ø1	L	A	B	Ø2	
	10	15+1	490	160	3/8" GAS	1 019100010

1914

spirali in poliuretano 98 Shore estensibili

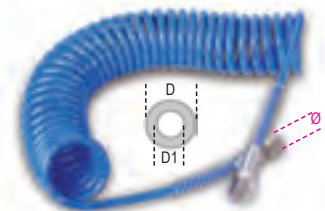

1914	L	D1xD	Ø GAS	
	4	5x8	1/4"	1 019140054
	6	5x8	1/4"	1 019140056
	10	5x8	1/4"	1 019140060

1915B

spirali in poliuretano 95 Shore
estensibili fino a 9 m

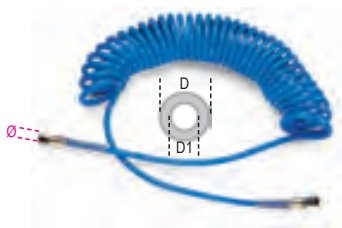

D1xD mm	Ø GAS BSP		
6,5x10	1/4"	1	019150011
8x12	1/4"	1	019150012
11x16	3/8"	1	019150013

1915C

spirali in poliuretano 95 Shore
estensibili fino a 12 m

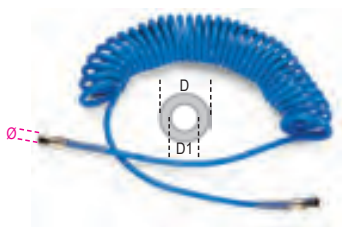

D1xD mm	Ø GAS BSP		
6,5x10	1/4"	1	019150014
8x12	1/4"	1	019150015
11x16	3/8"	1	019150016

1915C/L

spirali in poliuretano 95 Shore
estensibili fino a 15 m

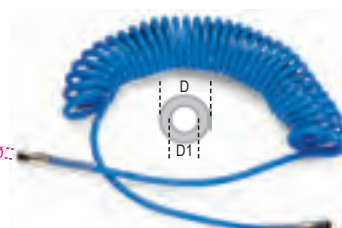

D1xD mm	Ø GAS BSP		
8x12	1/4"	1	019150115
11x16	3/8"	1	019150116

1915D

tubo in poliuretano retinato 95 Shore
lunghezza 9 m



D1xD mm	Ø GAS BSP		
8x12	1/4"	1	019150017
11x16	3/8"	1	019150018

1915E

tubo in poliuretano retinato 95 Shore
lunghezza 12 m



D1xD mm	Ø GAS BSP		
8x12	1/4"	1	019150019
11x16	3/8"	1	019150020

1915E/XL

bobine in poliuretano retinato 95 Shore
lunghezza 50 m



D1xD mm	Ø GAS BSP		
8x12	1/4"	1	019150519
11x16	3/8"	1	019150520

1916I

innesti rapidi profilo Italia
filettati maschio, GAS cilindrici BSP



Ø GAS BSP		
1/4"	5	019160001
3/8"	5	019160002

1916G

innesti rapidi profilo Europa
filettati maschio, GAS conici BSPT



Ø GAS BSPT		
1/4"	5	019160005
3/8"	5	019160010
1/2"	5	019160012

1917M

raccordi universali a sfera
con gomma antiurto
filettati maschio GAS cilindrici BSP

• accoppiabili agli innesti 1916I e 1916G



Ø GAS BSP		
1/4"	5	019170001
3/8"	5	019170003
1/2"	5	019170004

1917F

raccordi universali a sfera
con gomma antiurto
filettati femmina GAS cilindrici BSP

• accoppiabili agli innesti 1916I e 1916G



Ø GAS BSP		
1/4"	5	019170005
3/8"	5	019170010

1917RS

raccordo universale rotante

• In alluminio anodizzato arancione
filettati femmina, GAS cilindrici BSP
filettati maschio, GAS conici BSPT
• Accoppiabili a tutti gli innesti con profilo Italia ed Europa



Ø GAS BSP	Ø GAS BSPT	g	
1/4"	1/4"	57	1 019170250

1919FE1/4

filtro regolatore lubrificatore



Attacchi aria entrata/uscita	1/4" GAS BSPT
Attacco manometro	1/8" GAS BSPT
Portata massima	750 l/min
Pressione massima	9,5 Bar
Pressione di utilizzo	0,5 - 8,5 Bar
Temperatura di utilizzo	5 - 60 °C
Capacità filtrante	5 micron
Capacità tazze	15 cc aria / 25 cc olio
Peso	700 g

g	
700	1 019190200

1919RB-FE1/4

coppia bicchieri di ricambio
per 1919FE1/4



1919RB-FE1/4	1 019190210
--------------	-------------

1919RF-FE1/4

ricambio elemento filtrante
per 1919FE1/4



1919RF-FE1/4

1 019190230

1919RM-FE1/4

manometro di ricambio
per 1919FE1/4



1 019190220

1919F1/4

filtro regolatore lubrificatore



Attacchi aria entrata/uscita

Portata massima

Pressione massima

Pressione di utilizzo

Temperatura di utilizzo

Capacità filtrante

Capacità tazze

Peso

1/4" GAS BSPT

1000 l/min

9,5 Bar

0,5 - 8,5 Bar

5 - 60 °C

5 micron

60 cc aria / 90 cc olio

1,3 kg

kg
1,3

1 019190250

1919F3/8

filtro regolatore lubrificatore



Attacchi aria entrata/uscita

Portata massima

Pressione massima

Pressione di utilizzo

Temperatura di utilizzo

Capacità filtrante

Capacità tazze

Peso

3/8" GAS BSPT

1350 l/min

9,5 Bar

0,5 - 8,5 Bar

5 - 60 °C

5 micron

60 cc aria / 90 cc olio

1,3 kg

kg
1,3

1 019190350

1919F1/2

filtro regolatore lubrificatore



Attacchi aria entrata/uscita

Portata massima

Pressione massima

Pressione di utilizzo

Temperatura di utilizzo

Capacità filtrante

Capacità tazze

Peso

1/2" GAS BSPT

2500 l/min

9,5 Bar

0,5 - 8,5 Bar

5 - 60 °C

5 micron

60 cc aria / 90 cc olio

1,3 kg

kg
1,3

1 019190450

1919RB-F

coppia bicchieri
per filtri 1919F - 1/4", 3/8" e 1/2"



1919RB-F

1 019190510

1919RF-F

ricambio elemento filtrante
per filtri 1919F - 1/4", 3/8" e 1/2"



1919RF-F

1 019190530

1919RM-F

manometro di ricambio
per filtri 1919F - 1/4", 3/8" e 1/2"



1919RM-F

1 019190520

1919ML

mini lubrificatori di linea



Ø
1/4"
3/8"

1 019190030
1 019190032

1919SC

mini separatore di condensa



Ø
1/4"

1 019190035

1919L

olio lubrificatore ISO 32



Density 20°C
Viscosity 40°C
Flammability COC

875 Kg/m³
32 cSt
210°C

cc
500

5 019190050

Beta

CONTENITORI E ASSORTIMENTI



2001/B26

busta in tessuto con assortimento di 26 utensili



2001/B26

1 020010050

55 6x7 - 8x9 - 10x11 - 12x13 - 14x15 - 16x17 mm

96N/SC9 1,5 - 2 - 2,5 - 3 - 4 - 5 - 6 - 8 - 10 mm

1044F 250 mm

1128BMX 145 mm

1150 180 mm

1201 3x75 - 4x100 - 5,5x150 mm

1202 PH1x80 - PH2x100 mm

1370 300 g

1692 2 m

1770A 9 mm

2001/BV26

1 020010051

2005PA/D

porta attrezzi vuoto in Nylon, con cintura



2005PA/D

1 020050000

2005PA/S

porta attrezzi vuoto in Nylon, con cintura



2005PA/S

1 020050020

2009N/BV

borsa per manutentori in cuoio



530x190x210

1 020090200

2009ID

borsa con assortimento di 35 utensili per idraulica



2009ID
(2009N/BV+5980ID)

1 020090012

2029/VV

valigia portautensili in polipropilene ad alto spessore, profilata in alluminio.

2 pannelli portautensili
Fornita di tracolla



490x380x230

1 020290000

2029E

valigie con assortimenti di utensili per elettronica ed elettrotecnica



2029BG-MQ
(2029/VV+5980/MQ)

1 020290256

2029ET/B
(2029/VV+5980ET/B)

1 020290221

2029EL/B
(2029/VV+5980EL/B)

1 020290217

2029/RT

tracolla universale per borse e valigie



2029/RT

1 020290900

2032/VV

valigia portautensili in materiale plastico

2 pannelli portautensili



450x390x170

1 020320010

2032E

valigia con assortimento di utensili per elettronica ed elettrotecnica



2032ET/A
(2032/VV+5980ET/A)

1 020320118

2032EL/A
(2032/VV+5980EL/A)

1 020320114

2032/TV

trolley portautensili in materiale plastico

2 pannelli portautensili
Tasca portautensili interna
Fondo interno con divisori removibili



430x370x200

1 020320110

2032/TE

trolley con assortimento di utensili per elettronica ed elettrotecnica



2032TET/A (2032/TV+5980ET/A)	1 020320228
2032TEL/A (2032/TV+5980EL/A)	1 020320214

2033 P/VV

valigia portautensili, in alluminio con fianchi in ABS
2 pannelli portautensili
Fondo interno con divisori removibili



mm	1 020330300
500x380x200	

2033P

valigie con assortimenti di utensili per elettronica ed elettrotecnica



2033P ET/B (2033P/VV+5980ET/B)	1 020330127
2033P EL/A (2033P/VV+5980EL/A)	1 020330114
2033P EL/B (2033P/VV+5980EL/B)	1 020330115

2036/TV

trolley portautensili in polipropilene ad alto spessore, profilato in alluminio
2 pannelli portautensili
Manico telescopico
Ruote con cuscinetti a sfera
Fondo interno con divisori removibili



mm	1 020360000
490x380x260	

2036E

trolley con assortimenti di utensili per elettronica ed elettrotecnica



2036ET/B (2036/TV+5980ET/B)	1 020360123
2036 EL/B (2036/TV+5980EL/B)	1 020360118

2041UC

valigia Utility Case con assortimento di 33 utensili



2041UC	1 020410200
--------	-------------

- 55 6x7 - 8x9 - 10x11 - 12x13 - 14x15 - 16x17 mm
- 96/SC9 1,5 - 2 - 2,5 - 3 - 4 - 5 - 6 - 8 - 10 mm
- 111 200 mm
- 1048V 250 mm
- 1128BMX 145 mm
- 1150 180 mm
- 1201 2,5x50 - 3x75 - 4x100 - 5,5x100 - 6,5x150 mm
- 1202 PH0x60 - PH1x80 - PH2x100 mm
- 1370 300 g
- 1692 3m
- 1771 170 mm
- 1834/70 70 Lumen / 140 mm
- 1639NS-N 25m
- 1696 200 mm

535x282x87 mm - 4,5 Kg

2051N

valigia in polipropilene antiurto con assortimento di 55 utensili per nautica



2051N	1 020510200
-------	-------------

- 42 7 - 8 - 10 - 12 - 13 - 14 - 17 - 19 mm
- 55AS 3/8x7/16 - 1/2x9/16 - 5/8x11/16"
- 96/SC9 \varnothing 1,5+10 mm
- 111 200 mm
- 920A \varnothing 10 - 12 - 13 - 14 - 17 - 19 mm
- 920AS \varnothing 7/16 - 1/2 - 9/16 - 11/16 - 7/8"
- 920/22 255 mm - \square 1/2 - \blacksquare 1/2
- 920/25 \square 1/2 - \blacksquare 1/2
- 920/42 \blacksquare 1/2
- 920/55 \blacksquare 1/2
- 956C \square 1/2 - 16 - 20,8 mm
- 1048 250 mm
- 1084BM 160 mm
- 1128BMX 145 mm
- 1150BM 180 mm
- 1166BM 160 mm
- 1201 \varnothing 3x75 - 4x100 - 5,5x150 - 6,5x150 mm
- 1202 \varnothing PH1x80 - PH2x100 mm
- 1390 \varnothing 35 mm
- 1490/2 \varnothing max 240 mm
- 1737 145 mm
- 1778X
- 1995 WD40 400 ml
- 1639NS-N 25m

585x393x92 mm - 9 kg



2055HB

valigia Home Bag con assortimento di 24 utensili



2055HB 1 020550210

55 6x7 - 8x9 - 10x11 - 12x13 mm

96N/SC9 1,5 - 2 - 2,5 - 3 - 4 - 5 - 6 - 8 - 10 mm

1128BMX 145 mm

1150 180 mm

1048V 250 mm

1201 3x75 - 4x100 - 5,5x100 mm

1202 PH0x60 - PH1x80 - PH2x100 mm

1370 300 g

1692 3m

373x275x70 mm - 3 Kg

2060/VV

valigia portautensili per nautica a tenuta stagna

Galleggiante e impermeabile
In resina ad alto spessore
Dotata di valvola di rilascio a pressione manuale



490x410x210 mm 1 020600101

2080/V6

valigia organizer con 6 vaschette asportabili e divisori regolabili



2080/V6 385x320x60 mm 1 020800060

2080/V6-U

vaschetta asportabile per valigia organizer 2080/V6



2080/V6-U 1 020800066

90x60x50 mm

2080/V12

valigia organizer con 12 vaschette asportabili



2080/V12 300x145x330 mm 1 020800000

2080/V12-...

vaschetta asportabile per valigia organizer 2080/V12



2080/V12-S 3 020800013

2080/V12-M 2 020800015

2080/V12-L 1 020800020

143x74x69 mm

95x65x65 mm

295x73x67 mm

C4 - 2104

secchiello portautensili in tessuto tecnico

Pannello portautensili interno estraibile
Tasche ed elastici portautensili sia esterni che interni
Base rigida impermeabile con piedini in gomma
Fornito di tracolla



C4 1 021040000

2104 VU/0 1 021040121

(C4+5915VU/0)

360x330x260 mm - 2,5 kg

C5 - 2105

zaino portautensili in tessuto tecnico

- Pannello portautensili interno removibile
- Sei tasche esterne
- Due capienti tasche interne
- Base in materiale plastico resistente all'acqua
- Doppio laccetto di sicurezza per fissare lo zaino sulle spalle
- Schienale ergonomico imbottito



C5 1 021050000

2105 VU/0 1 021050121

(C5+5915VU/0)

500x400x180 mm - 2,5 Kg

 Beta

C6T - 2106

zaino portautensili in tessuto tecnico, con ruote

- Manico telescopico di trasporto
- Ruote integrate nella struttura con copertura anti-polvere per l'impiego come zaino
- Due pannelli portautensili removibili
- Cinque tasche esterne
- Capiente tasca per pc interna
- Base in materiale resistente all'acqua



C6T 1 021060010
2106T VU/0 1 021060121
 (C6T+5915VU/0)
 ≡ 480x370x220 mm - 4,5 kg

C7 - 2107

borsa portautensili in tessuto tecnico

- 2 pannelli interni portautensili removibili
- 2 tasche esterne frontali
- Fondo interno in materiale plastico con divisori removibili



C7 1 021070000
2107 VU/2 1 021070102
 (C7+5915VU/2)
2107 VU/3 1 021070104
 (C7+5915VU/3)

Beta

C8 - 2108

trolley portautensili in tessuto tecnico

- Manico telescopico di trasporto
- 2 pannelli interni portautensili removibili
- Tasca porta PC interna
- 2 tasche esterne frontali
- Predisposizione per l'alloggiamento del cestello C10S



C8 1 021080000
2108VU/1 1 021080021
 (C8+5915VU/1)
 ≡ 470x370x280 mm - 4 kg

C9 - 2109

borsa portautensili in tessuto tecnico

- Base rigida
- Tasche interne ed esterne per l'inserimento di utensili
- Tasca esterna con chiusura a zip per maggior sicurezza
- Tasca chiudibile con strappo per oggetti personali
- Doppio fondo
- Doppio laccio per livelle
- Tracolla per facilitare il trasporto



C9 1 021090000
2109VU/1 1 021090021
 (C9+5915VU/1)
2109VU/3 1 021090124
 (C9+5915VU/3)

C9/RT

tracolla per C4,C7,C9,C10,C10S,C11 e C12



C9/RT 1 021090900

C10 - 2110

cestello portautensili in tessuto tecnico

- Struttura rigida
- Doppio fondo. Il fondo si può rimuovere per aumentare la capienza della borsa
- Manico inclinabile per facilitare l'accesso agli utensili
- Elastici portautensili e tasche sia interne che esterne
- Fodero di copertura
- Vaschetta portaminuterie incusa nel doppio fondo



C10 1 021100000
2110VU/1 1 021100021
 (C10+5915VU/1)
2110VU/3 1 021100024
 (C10+5915VU/3)
2110VU/AS 1 021100026
 (C10+5915VU/AS)

C10S - 2110S

cestello portautensili in tessuto tecnico

- Struttura rigida
- Manico inclinabile per facilitare l'accesso agli utensili
- Elastici portautensili e tasche sia interne che esterne
- Fodero di copertura
- Vaschetta portaminuterie incusa nel doppio fondo



C10S 1 021100001
2110SVU/1 1 021100101
 (C10S+5915VU/1)
2110SVU/3 1 021100104
 (C10S+5915VU/3)

C11 - 2111

cestello portautensili in tessuto tecnico

- Base rigida in materiale plastico resistente all'acqua
- Elastici e tasche portautensili sia interne che esterne
- Buste portadocumenti integrate nel doppiofondo del coperchio



C11	1	021110000
2111VU/1 (C11+5915VU/1)	1	021110101
2111VU/3 (C11+5915VU/3)	1	021110104

C12 - 2112

borsa portautensili in tessuto tecnico

Pannello interno portautensili estraibile
Elastici portautensili e capienti tasche sia interne che esterne
La borsa si apre anteriormente per facilitare l'accesso agli utensili sul luogo di lavoro
Base rigida impermeabile con piedini in gomma



C12	1	021120000
2112ET/A (C12+5980ET/A)	1	021120128
2112ET/B (C12+5980ET/B)	1	021120129
2112VU/5 (C12+5915VU/5)	1	021120156

C13

baule portautensili con ruote,
in polipropilene ad alta resistenza



C13	1	021130000
-----	---	-----------

870x410x350 mm - 7,2 kg

CP15 - 2115

cestello in materiale plastico con contenitore e
vaschette portaminuterie asportabili

- 1 vaschetta portaminuterie integrata nel coperchio
- 2 vaschette portaminuterie asportabili con divisori regolabili
- 1 contenitore interno con divisori regolabili



CP15	1	021150201
2115P VU/1 (CP15+5915VU/1)	1	021150231
2115P VU/2 (CP15+5915VU/2)	1	021150233

445x240x250 mm - 2 kg

CP15L - 2115

cestello modello lungo in materiale plastico
con contenitore e vaschette portaminuterie

- 3 vaschette portaminuterie integrate nel coperchio con divisori regolabili
- 1 contenitore interno con divisori regolabili



CP15L	1	021150202
2115P L-VU/1 (CP15L+5915VU/1)	1	021150241
2115P L-VU/3 (CP15L+5915VU/3)	1	021150244

2115P L-MQ32

assortimento di 32 utensili isolati per auto
ibride, in cestello plastico con termoformato
morbido



2115P L-MQ32	1	021150332
--------------	---	-----------

920MQ/55A	89MQ 10-12 mm
850MQ 1/4"	
860TX/A10	T7-T8-T9-T10-T15-T20-T25-T27-T30-T40
920MQ/A	8-10-12-13-14-17-19 mm
920MQ/21	125mm
920MQ/22	250mm
1048MQ250	250mm
1150MQ	180mm
1164MQ160	160mm
1272MQ	4.5X80-6X100mm
1274MQ	3X100-4X100-5.5X125
1995MQ/G2	G2
CP15L	

C16 - 2116

cestello in materiale plastico
con vano portaoggetti interno



C16	1	021160000
2116VU/1 (C16+5915VU/1)	1	021160101
2116VU/3 (C16+5915VU/3)	1	021160104



CP17 - CP17L - 2117

cestello in acciaio inox e materiale plastico
con contenitore asportabile



CP17
500x200x220 mm



CP17L
575x245x265 mm

CP17	1	021170500
2117PVU/1 (CP17+5915VU/1)	1	021170041
2117PVU/3 (CP17+5915VU/3)	1	021170044
CP17L	1	021170502
2117PLVU/1 (CP17L+5915VU/1)	1	021170141
2117PLVU/3 (CP17L+5915VU/3)	1	021170144

C18 - 2118

cestello semplice
in lamiera



C18	1	021180001
2118VU/1 (C18+5915VU/1)	1	021180031

450x200x100 mm - 3 kg

C19 - 2119 - C19L - 2119L

cestello estendibile
a tre scomparti
in lamiera



C19	1	021190001
C19L	1	021190002
2119VU/3 (C19+5915VU/3)	1	021190024
2119L-VU/3 (C19L+5915VU/3)	1	021190124

C20 - C20L - 2120

cestello estendibile
a cinque scomparti
in lamiera



C20	1	021200001
2120VU/2 (C20+5915VU/2)	1	021200016
2120VU/3 (C20+5915VU/3)	1	021200028
2120VU/4 (C20+5915VU/4)	1	021200018
2120-VU/AS (C20+5915VU/AS)	1	021200021
C20L	1	021200002
2120LVU/2 (C20L+5915VU/2)	1	021200116
2120L-VU/3 (C20L+5915VU/3)	1	021200128
2120LVU/4 (C20L+5915VU/4)	1	021200118
2120L-VU/AS (C20L+5915VU/AS)	1	021200121

C22B

baule portautensili in lamiera



C22B O	1	022000150
C22BM O	1	022000160
C22BL O	1	022000170

C22B O: 13 kg
C22BM O: 20 kg
C22BL O: 26 kg

C22W

baule portautensili in lamiera, rivestito
internamente per una maggiore protezione
degli utensili



C22W O	1	022000269
C22WL O	1	022000299

C22W O: 15 kg
C22WL O: 28 kg

C22P

baule portautensili da cantiere, in lamiera

maniglie incassate a scomparsa
pattini rialzati per il sollevamento con muletto
doppia chiusura anti-effrazione per lucchetto (non incluso)



C22PM O	1	022000240
C22PL O	1	022000245

C22PM O: 39 kg
C22PL O: 67 kg

Beta

C22S - 2200S

cassettiera portatile
con tre cassetti

Caratteristiche principali:

- Tre cassetti da 588x277 mm, montati su guide telescopiche a sfera:
- 1 cassetto altezza 50 mm
- 2 cassetti altezza 70 mm.
- Serratura centralizzata frontale.
- Maniglie laterali a scomparsa per il trasporto.

19 kg

C22S O		1	022000501	
2200S-O/VUM	(C22S-O+5927VU/M)	1	022000221	314
2200S-O/VI	(C22S-O+5902VI)	1	022000461	294
2200S-O/MT	(C22S-O+5902MT)	1	022000431	325
2200S-O/MTAS	(C22S-O+5902MT/AS)	1	022000441	326
C22S G		1	022000502	
2200S-G/VUM	(C22S-G+5927VU/M)	1	022000222	314
2200S-G/VI	(C22S-G+5902VI)	1	022000462	294
2200S-G/MT	(C22S-G+5902MT)	1	022000432	325
2200S-G/MTAS	(C22S-G+5902MT/AS)	1	022000442	326
C22S R		1	022000503	
2200S-R/VUM	(C22S-R+5927VU/M)	1	022000223	314
2200S-R/VI	(C22S-R+5902VI)	1	022000463	294
2200S-R/MT	(C22S-R+5902MT)	1	022000433	325
2200S-R/MTAS	(C22S-R+5902MT/AS)	1 </td <td>022000443</td> <td>326</td>	022000443	326



C22S O



C22S G



C22S R



h	max
50 mm	25 kg
70 mm	25 kg

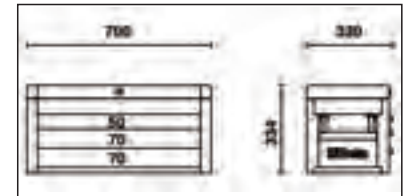

C23S - 2300S

cassettiera portatile
con cinque cassetti

Caratteristiche principali:

- Cinque cassetti da 588x277 mm, montati su guide telescopiche a sfera:
- 2 cassetti altezza 50 mm
- 3 cassetti altezza 70 mm.
- Serratura centralizzata frontale.
- Maniglie laterali a scomparsa per il trasporto.

26 kg

C23S O		1	023000501	
C23S G		1	023000502	
C23S R		1	023000503	



C23S O



C23S G



C23S R



h	max
50 mm	25 kg
70 mm	25 kg

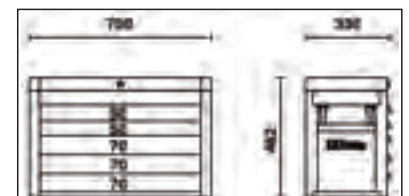

C23SC - 2300SC

cassettiera portatile
con otto cassetti

Caratteristiche principali:

- Otto cassetti montati su guide telescopiche a sfera:
- 4 cassetti altezza 50 mm
- 3 cassetti altezza 70 mm
- 1 cassetto altezza 100 mm.
- Serratura centralizzata frontale.
- Maniglie laterali a scomparsa per il trasporto.

📦 28 kg



C23SC O



C23SC G

C23SC R



340

h	max
50 mm	25 kg

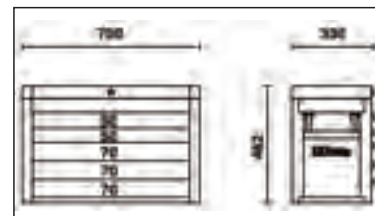
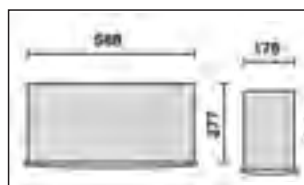

C23SC O	1	023000511
C23SC G	1	023000512
C23SC R	1	023000513

C23ST - 2300ST

cassettiera portatile
con cinque cassetti

Caratteristiche principali:

- Cinque cassetti da 588x367 mm, montati su guide telescopiche a sfera:
- 5 cassetti altezza 70 mm
- Serratura centralizzata frontale.
- Possibilità di applicazione del kit 4 ruote più maniglione (2300ST/KIT)

📦 36 kg



C23ST O

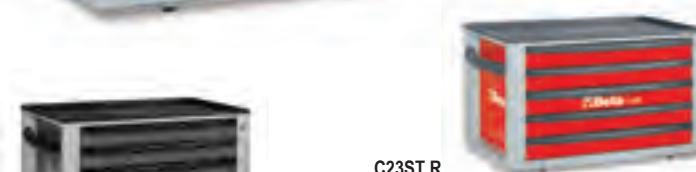

C23ST R

C23ST G



340

h	max
70 mm	25 kg

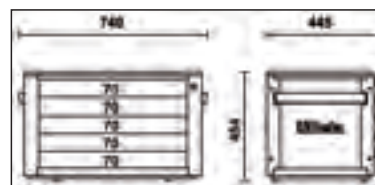

C23ST O	1	023000521	
2300ST-O/VG1M (C23ST O+5904VG/1M)	1	023000685	327
C23ST G	1	023000522	
2300ST-G/VG1M (C23ST G+5904VG/1M)	1	023000686	327
C23ST R	1	023000523	
2300ST-R/VG1M (C23ST R+5904VG/1M)	1	023000687	327

2300ST/KIT

kit con quattro ruote e maniglione per C23ST

- Quattro ruote Ø 125 mm:
2 fisse e 2 girevoli (una con freno).
- Maniglione telescopico

6,5 kg



2300ST/KIT

1 023000950

CD23S

carrello Caddy

Caratteristiche principali:

- Piano di lavoro ricoperto in ABS
sul quale sono collocabili a misura le cassettiere
C22S, C23S, C23SC, C23ST
- Timone di guida smontabile, collocabile sotto il piano.
- Quattro ruote Ø 100 mm:
2 fisse e 2 girevoli (una con freno).
- Portata massima 250 kg.

14 kg



CD23S

1 023000610

C04 TSS-7

cassetiera mobile con sette cassetti completamente
in acciaio inossidabile

Caratteristiche principali:

- Sette cassetti da 570 x 410 mm
montati su guide telescopiche a sfera;
- 6 cassetti altezza 83 mm;
- 1 cassetto altezza 170 mm;
- 4 ruote Ø 125mm
- 2 fisse e 2 girevoli (due con freno);
- Serratura frontale centralizzata;
- Struttura interamente in acciaio inossidabile
- Ruote, supporti, sfere, interno dei cassetti e relative guide in acciaio
inossidabile
- Maniglia cassetti in alluminio

63 kg



h	max
83 mm	25 kg
170 mm	30 kg

C04 TSS/7

1 024003077 207

C24S/5 - 2400S5

cassettiera mobile con cinque cassetti

Caratteristiche principali:

- Cinque cassetti da 588x367 mm, montati su guide telescopiche a sfera:
- 2 cassetti altezza 70 mm
- 2 cassetti altezza 140 mm
- 1 cassetto altezza 280 mm
- Piano dei cassetti protetto da tappetini di gomma espansa.
- Quattro ruote Ø 125 mm:
- 2 fisse e 2 girevoli (una con freno).
- Serratura di sicurezza centralizzata frontale.
- Capacità di carico statico: 800 kg.
- Piano di lavoro termoplastico sul quale è collocabile a misura una cassettera C22S, C23S, C23SC e C23ST
- Portaflacone laterale integrato.
- Possibilità di applicazione del portacarta 2400S-R/PC.

52 kg



h	max
70 mm	25 kg
140 mm	30 kg
280 mm	35 kg

Model	Accessories	Qty	Code	Price
C24S O/5		1	024002051	
2400S5-O/VI1T	(C24S5/O+5904VI/1T)	1	024002504	295
2400S5-O/VG2T	(C24S5/O+5904VG/2T)	1	024002514	329
2400S5-O/VU1M	(C24S5/ O+5904VU/1M)	1	024002517	304
C24S G/5		1	024002052	
2400S5-G/VI1T	(C24S5/G+5904VI/1T)	1	024002505	295
2400S5-G/VG2T	(C24S5/G+5904VG/2T)	1	024002515	329
2400S5-G/VU1M	(C24S5/G+5904VU/1M)	1	024002518	304
C24S R/5		1	024002053	
2400S5-R/VI1T	(C24S5/R+5904VI/1T)	1	024002506	295
2400S5-R/VG2T	(C24S5/R+5904VG/2T)	1	024002516	329
2400S5-R/VU1M	(C24S5/R+5904VU/1M)	1	024002519	304

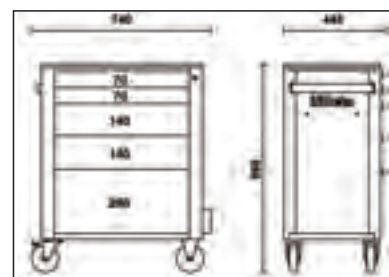

C24S/6 - 2400S6

cassettiera mobile con sei cassetti

Caratteristiche principali:

- Sei cassetti da 588x367 mm, montati su guide telescopiche a sfera:
- 4 cassetti altezza 70 mm
- 1 cassetto altezza 140 mm
- 1 cassetto altezza 280 mm
- Piano dei cassetti protetto da tappetini di gomma espansa.
- Quattro ruote Ø 125 mm:
- 2 fisse e 2 girevoli (una con freno).
- Serratura di sicurezza centralizzata frontale.
- Capacità di carico statico: 800 kg.
- Piano di lavoro termoplastico sul quale è collocabile a misura una cassetteria C22S, C23S, C23SC e C23ST
- Portaflacone laterale integrato.
- Possibilità di applicazione del portacarta 2400S-R/PC.

55 kg



C24S O/6



C24S G/6



C24S R/6

h	max
70 mm	25 kg
140 mm	30 kg
280 mm	35 kg

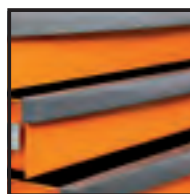

Model	Qty	Code	Price
C24S O/6	1	024002061	
2400S6-O/VI1T (C24S6/O+5904VI/1T)	1	024002614	295
2400S6-O/VG2T (C24S6/O+5904VG/2T)	1	024002624	329
C24S G/6	1	024002062	
2400S6-G/VI1T (C24S6/G+5904VI/1T)	1	024002615	295
2400S6-G/VG2T (C24S6/G+5904VG/2T)	1	024002625	329
C24S R/6	1	024002063	
2400S6-R/VI1T (C24S6/R+5904VI/1T)	1	024002616	295
2400S6-R/VG2T (C24S6/R+5904VG/2T)	1	024002626	329

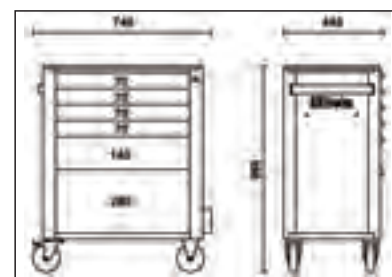

C24S/7 - 2400S7

cassettiera mobile con sette cassetti

Caratteristiche principali:

- Sette cassetti da 588x367 mm, montati su guide telescopiche a sfera:
- 5 cassetti altezza 70 mm
- 1 cassetto altezza 140 mm
- 1 cassetto altezza 210 mm
- Piano dei cassetti protetto da tappetini di gomma espansa.
- Quattro ruote Ø 125 mm: 2 fisse e 2 girevoli (una con freno).
- Serratura di sicurezza centralizzata frontale.
- Capacità di carico statico: 800 kg.
- Piano di lavoro termoplastico sul quale è collocabile a misura una cassettera C22S, C23S, C23SC e C23ST
- Portaflacone laterale integrato.
- Possibilità di applicazione del portacarta 2400S-R/PC.

📦 58 kg



C24S O/7



C24S G/7



C24S R/7

h	max
70 mm	25 kg
140 mm	30 kg
210 mm	30 kg

Model	Accessories	Qty	Code	Price
C24S O/7		1	024002071	
2400S7-O/VG3	(C24S7/O+5904VG/3)	1	024002734	330
2400S7-O/VG2M	(C24S7/O+5904VG/2M)	1	024002774	328
2400S7-O/VU2M	(C24S7/O+5904VU/2M)	1	024002744	305
2400S7-O/VU3T	(C24S7/O+5904VU/3T)	1	024002747	306
2400S7-O/VI2T	(C24S7/O+5904VI/2T)	1	024002434	296
C24S G/7		1	024002072	
2400S7-G/VG3	(C24S7/G+5904VG/3)	1	024002735	330
2400S7-G/VG2M	(C24S7/G+5904VG/2M)	1	024002775	328
2400S7-G/VU2M	(C24S7/G+5904VU/2M)	1	024002745	305
2400S7-G/VU3T	(C24S7/G+5904VU/3T)	1	024002748	306
2400S7-G/VI2T	(C24S7/G+5904VI/2T)	1	024002435	296
C24S R/7		1	024002073	
2400S7-R/VG3	(C24S7/R+5904VG/3)	1	024002736	330
2400S7-R/VG2M	(C24S7/R+5904VG/2M)	1	024002776	328
2400S7-R/VU2M	(C24S7/R+5904VU/2M)	1	024002746	305
2400S7-R/VU3T	(C24S7/R+5904VU/3T)	1	024002749	306
2400S7-R/VI2T	(C24S7/R+5904VI/2T)	1	024002436	296

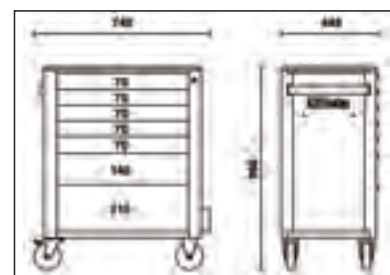

C24S/8 - 2400S8

cassettiera mobile con otto cassetti

Caratteristiche principali:

- Otto cassetti da 588x367 mm, montati su guide telescopiche a sfera:
- 6 cassetti altezza 70 mm
- 2 cassetti altezza 140 mm
- Piano dei cassetti protetto da tappetini di gomma espansa.
- Quattro ruote Ø 125 mm:
- 2 fisse e 2 girevoli (una con freno).
- Serratura di sicurezza centralizzata frontale.
- Capacità di carico statico: 800 kg.
- Piano di lavoro termoplastico sul quale è collocabile a misura una cassettera C22S, C23S, C23SC e C23ST
- Portaflacone laterale integrato.
- Possibilità di applicazione del portacarta 2400S-R/PC.

61 kg



h	max
70 mm	25 kg
140 mm	30 kg

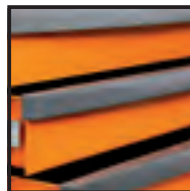

Model	Qty	Code	Price
C24S O/8	1	024002081	
2400 S8-O/VI3T (C24S8/O+5904VI/3T)	1	024002861	297
2400S8-O/VG5T (C24S8/O+5904VG/5T)	1	024002824	331
C24S G/8	1	024002082	
2400 S8-G/VI3T (C24S8/G+5904VI/3T)	1	024002862	297
2400S8-G/VG5T (C24S8/G+5904VG/5T)	1	024002825	331
C24S R/8	1	024002083	
2400S8-R/VG5T (C24S8/R+5904VG/5T)	1	024002826	331
2400 S8-R/VI3T (C24S8/R+5904VI/3T)	1	024002863	297

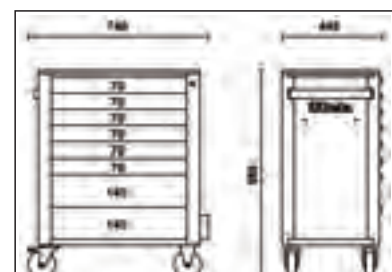

C24SA/6 - 2400SA6

cassettiera mobile con sei cassetti, con sistema antiribaltamento

Caratteristiche principali:

- Sei cassetti da 588x367 mm, montati su guide telescopiche a sfera:
- 4 cassetti altezza 70 mm
- 1 cassetto altezza 140 mm
- 1 cassetto altezza 280 mm
- Piano dei cassetti protetto da tappetini di gomma espansa.
- Quattro ruote Ø 125 mm: 2 fisse e 2 girevoli (una con freno).
- Serratura di sicurezza centralizzata frontale.
- Capacità di carico statico: 800 kg.
- Piano di lavoro termoplastico sul quale è collocabile a misura una cassettera C22S, C23S, C23SC e C23ST
- Portaflacone laterale integrato.
- Possibilità di applicazione del portacarta 2400S-R/PC.

55 kg



C24SA-O/6



C24SA-G/6



C24SA-R/6

h	max
70 mm	25 kg
140 mm	30 kg
280 mm	35 kg

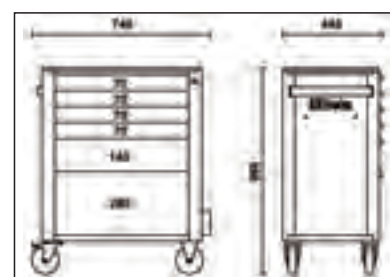

C24SA-O/6	1	024002161
C24SA-G/6	1	024002162
C24SA-R/6	1	024002163

C24SA/7 - 2400SA7

cassettera mobile con sette cassetti, con sistema antiribaltamento

Caratteristiche principali:

- Sette cassetti da 588x367 mm, montati su guide telescopiche a sfera:
- 5 cassetti altezza 70 mm
- 1 cassetto altezza 140 mm
- 1 cassetto altezza 210 mm
- Piano dei cassetti protetto da tappetini di gomma espansa.
- Quattro ruote Ø 125 mm:
- 2 fisse e 2 girevoli (una con freno).
- Serratura di sicurezza centralizzata frontale.
- Capacità di carico statico: 800 kg.
- Piano di lavoro termoplastico sul quale è collocabile a misura una cassettera C22S, C23S, C23SC e C23ST
- Portaflacone laterale integrato.
- Possibilità di applicazione del portacarta 2400S-R/PC.

58 kg



C24SA-0/7



C24SA-G/7



C24SA-R/7

h	max
70 mm	25 kg
140 mm	30 kg
210 mm	30 kg



Model	Accessories	Qty	Code	Weight
C24SA-0/7		1	024002171	
2400SA7-0/VG3	(C24SA7/O+5904VG/3)	1	024002737	330
C24SA-G/7		1	024002172	
2400SA7-G/VG3	(C24SA7/G+5904VG/3)	1	024002738	330
C24SA-R/7		1	024002173	
2400SA7-R/VG3	(C24SA7/R+5904VG/3)	1	024002739	330

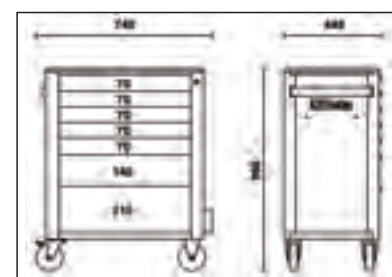

C24SA/8 - 2400SA8

cassettiera mobile con otto cassetti, con sistema antiribaltamento

Caratteristiche principali:

- Otto cassetti da 588x367 mm, montati su guide telescopiche a sfera:
- 6 cassetti altezza 70 mm
- 2 cassetto altezza 140 mm
- Piano dei cassetti protetto da tappetini di gomma espansa.
- Quattro ruote Ø 125 mm:
- 2 fisse e 2 girevoli (una con freno).
- Serratura di sicurezza centralizzata frontale.
- Capacità di carico statico: 800 kg.
- Piano di lavoro termoplastico sul quale è collocabile a misura una cassettera C22S, C23S, C23SC e C23ST
- Portaflacone laterale integrato.
- Possibilità di applicazione del portacarta 2400S-R/PC.

61 kg



C24SA-O/8



C24SA-G/8

C24SA-R/8

h	max
70 mm	25 kg
140 mm	30 kg

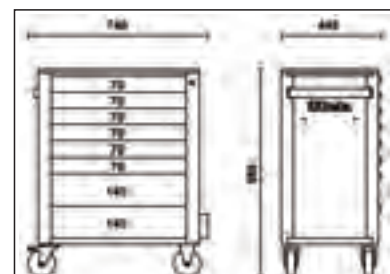

C24SA-O/8	1	024002181
C24SA-G/8	1	024002182
C24SA-R/8	1	024002183

C24SA-XL/7 - 2400SAXL7

cassetiera mobile con sette cassetti, con sistema antiribaltamento, modello lungo

Caratteristiche principali:

- 7 cassetti da 882x367 mm, montati su guide telescopiche a sfera:
- 5 cassetti altezza 70 mm
- 1 cassetto altezza 140 mm
- 1 cassetto altezza 210 mm
- Piano di lavoro in ABS ad alta resistenza, con 6 vaschette portaminuterie.
- Frontalino in nylon ad alta resistenza, con porta-etichette integrato.
- Piano dei cassetti protetto da tappetini di gomma espansa.
- Quattro ruote Ø 125 mm: 2 fisse e 2 girevoli (una con freno).
- Serratura di sicurezza centralizzata frontale.
- Capacità di carico statico: 1.000 kg.
- Portaflaconi laterale integrato.
- Possibilità di applicazione del portacarta 2400S-R/PC.

84 kg

1000 kg



C24SA-XL 7/O



C24SA-XL 7/G



C24SA-XL 7/R

h	max
70 mm	30 kg
140 mm	35 kg
210 mm	35 kg



Model	QTY	Code	Price
C24SA-XL 7/O	1	024002271	
2400SAXL7-O/VI3T (C24SA-XL/7 O+5904VI/3T)	1	024002464	297
C24SA-XL 7/G	1	024002272	
2400SAXL7-G/VI3T (C24SA-XL/7 G+5904VI/3T)	1	024002465	297
C24SA-XL 7/R	1	024002273	
2400SAXL7-R/VI3T (C24SA-XL/7 R+5904VI/3T)	1	024002466	297

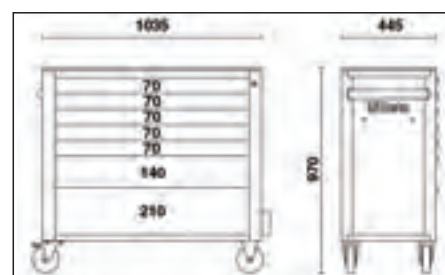

C24SA-XL/8 - 2400SAXL8

cassettiera mobile con otto cassetti,
con sistema antiribaltamento,
modello lungo

Caratteristiche principali:

- 8 cassetti da 882x367 mm, montati su guide telescopiche a sfera:
- 6 cassetti altezza 70 mm
- 2 cassetto altezza 140 mm
- Piano di lavoro in ABS ad alta resistenza, con 6 vaschette portaminuterie.
- Frontalino in nylon ad alta resistenza, con porta-etichette integrato.
- Piano dei cassetti protetto da tappetini di gomma espansa.
- Quattro ruote Ø 125 mm: 2 fisse e 2 girevoli (una con freno).
- Serratura di sicurezza centralizzata frontale.
- Capacità di carico statico: 1.000 kg.
- Portaflaconi laterale integrato.
- Possibilità di applicazione del portacarta 2400S-R/PC.

88 kg

1000 kg



C24SA-XL 8/O



C24SA-XL 8/G



C24SA-XL 8/R

h	max
70 mm	30 kg
140 mm	35 kg

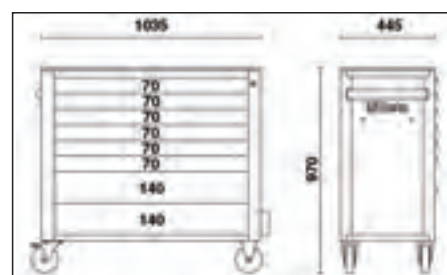

C24SA-XL 8/O	1	024002281
C24SA-XL 8/G	1	024002282
C24SA-XL 8/R	1	024002283

2400S-R/PC

portacarta per rotoli preforati

- Abbinabile alle cassettiere serie C24S

0,3 kg



- 2400S R/PC-O
- 2400S R/PC-G
- 2400S R/PC-R



2400S R/PC-O	1	024002951
2400S R/PC-G	1	024002952
2400S R/PC-R	1	024002953

2400S/PF

portaflaconi

- Abbinabile alle cassettiere serie C24S

0,5 kg



2400S/PF	1	024002906
----------	---	-----------

2499PF

portaflaconi

- Abbinabile alle cassettiere serie C38 e C38A

2,5 kg

- 2499PF O
- 2499PF G
- 2499PF R



2499PF O	1	024990210
2499PF G	1	024990219
2499PF R	1	024990230

Beta

2499PF/M

portaflaconi universale magnetico

2,2 kg



2499PF/M



1 024990050

2499PC

portacarta per rotoli preforati

• Abbinabile a tutti i carrelli Tank C25 e alle cassettiere serie C38 e C38A.

2,2 kg



2499PC



1 024990090



C24SL - 2400SL

cassettiera mobile
con sette cassetti
e ripiani laterali

Caratteristiche principali:

- Sette cassetti da 588x367 mm, montati su guide telescopiche a sfera:
- 5 cassetti altezza 70 mm
- 1 cassetto altezza 140 mm
- 1 cassetto altezza 210 mm.
- Piano dei cassetti protetto da tappetini di gomma espansa.
- Quattro ruote Ø 125 mm:
- 2 fisse e 2 girevoli (due con freno).
- Serratura centralizzata frontale.
- Capacità di carico statico: 1.100 kg.
- Piano di lavoro in legno multistrato con fori per la collocazione di una morsa (1599F/100 da ordinare separatamente).
- Vano laterale con ripiano regolabile in altezza.
- Portacarta integrato.
- Doppio portaflaconi posteriore.

80 kg



C24SL G

C24SL R

h	max
70 mm	25 kg
140 mm	30 kg
210 mm	30 kg

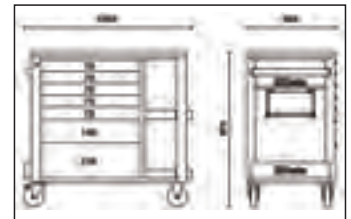
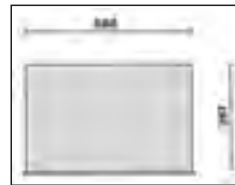

Model	Accessories	Qty	Code	Price
C24SL O		1	024002101	
2400SL-O/VI2T	(C24SL/7 O+5904VI/2T)	1	024002431	296
C24SL G		1	024002102	
2400SL-G/VI2T	(C24SL/7 G+5904VI/2T)	1	024002432	296
C24SL R		1	024002103	
2400SL-R/VI2T	(C24SL/7 R+5904VI/2T)	1	024002433	296

C25 - 2500

carrello Tank con mensola

Caratteristiche principali:

- Coperchio di chiusura ribaltabile.
- 1 cassetto scorrevole.
- Piano di alloggiamento utensili protetto da tappetini di gomma espansa.
- Piani di servizio protetti con tappetini in gomma antioil e antibenzina.
- Quattro ruote Ø 100 mm:
- 2 fisse e 2 girevoli (una con freno).
- Serratura centralizzata frontale.
- Termoformato vuoto per bussole e accessori da 1/2" (024990104)
- Possibilità di applicazione del portacarta 2499PC.

31,5 kg



Model	Accessories	Qty	Code	Price
C25		1	025000001	
2500/VI	(C25+5902VI)	1	025000087	294
2500/VG1	(C25+5905VG/1)	1	025000092	332
2500/VG2	(C25+5905VG/2)	1	025000084	333

C27S

carrello portautensili richiudibile per interventi esterni

Struttura in lamiera.

Carrello richiudibile con colonnine ribaltabili per permettere un agevole trasporto.

2 cassetti 588x277 mm montati su guide telescopiche che permettono l'apertura in due sensi.

Ampio vano portaoggetti inferiore 588x277x220 mm.

2 ruote fisse Ø 160 mm e 2 ruote piroettanti con freno Ø 100 mm

Piano di lavoro termoplastico con 6 vaschette portaminuterie integrate.

Chiusura centralizzata.

Predisposizione per l'alloggiamento di separatori per cassetto e termoformati portautensili MC.

20 kg



h	max
70 mm	20 kg



Model	Accessories	Code	Price
C27S-O	1	027000201	
2700 S-O/VUM (C27S O+5927VU/M)	1	027000221	314
C27S-G	1	027000202	
2700S-G/VUM (C27S G+5927VU/M)	1	027000222	314
C27S-R	1	027000203	
2700S-R/VUM (C27S R+5927VU/M)	1	027000223	314

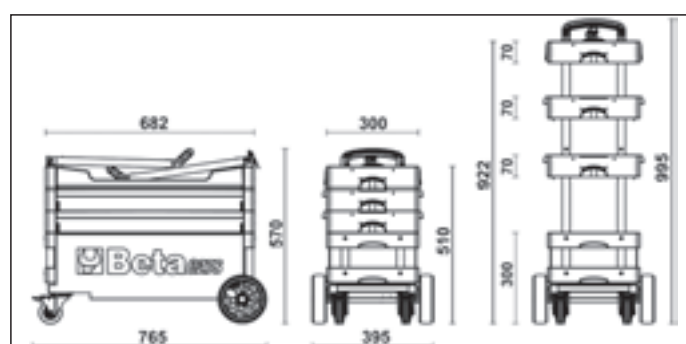

C28 - 2800

carrello SuperTank con piano di lavoro e dieci cassetti

Caratteristiche principali:

- Dieci cassetti da 588x367 mm, montati su guide telescopiche a sfera.
- Sistema rapido e sicuro per l'apertura e chiusura dei cassetti con frontalino in nylon e fibra di vetro.
- Cinque cassetti laterali di cui:
 - 4 cassetti altezza 70 mm
 - 1 cassetto altezza 210 mm.
- Cinque cassetti frontali di cui:
 - 4 cassetti altezza 70 mm
 - 1 cassetto altezza 210 mm.
- Piano dei cassetti protetto da tappetini di gomma espansa.
- Quattro ruote ad alta portata Ø 150 mm: 2 fisse e 2 girevoli con freno.
- 2 serrature di sicurezza centralizzate.
- 3 cassettini frontali portaoggetti.
- Piano di lavoro in legno multistrato con fori per la collocazione di una morsa (1599F/150 da ordinare separatamente).
- Vano integrato portaminuterie.
- Vano laterale con antina di chiusura a scomparsa con serratura.
- Portaflaconi integrati.
- Vano passante altezza 135 mm con base ricoperta in materiale plastico.
- Capacità di carico statico: kg 1200.

130 kg

1200
kg



C28 O



C28 G



C28 R



C28 O	1	028000301	
2800 O/VI2T (C28 O+5908VI/2T)	1	028000324	298
2800 O/VG2T (C28 O+5908VG/2T)	1	028000347	334
C28 G	1	028000302	
2800 G/VI2T (C28 G+5908VI/2T)	1	028000325	298
2800 G/VG2T (C28 G+5908VG/2T)	1	028000348	334
C28 R	1	028000303	
2800 R/VI2T (C28 R+5908VI/2T)	1	028000326	298
2800 R/VG2T (C28 R+5908VG/2T)	1	028000349	334

h	max
70 mm	25 kg
210 mm	30 kg

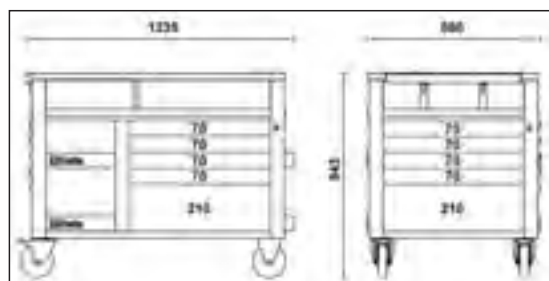

C30S - 3000S

postazione di lavoro mobile MaxiTank

Caratteristiche principali:

- 5 cassetti frontali montati su guide telescopiche a sfera:
- 3 cassetti 367x588 mm, altezza 90 mm
- 1 cassetto 610x588 mm, altezza 90 mm
- 1 cassetto 610x588 mm, altezza 180 mm
- Sistema di apertura rapido con frontalino in alluminio.
- Piano dei cassetti protetto da tappetini di gomma espansa.
- Predisposizione per l'inserimento di termoformati.
- Un martinetto idraulico consente, senza sforzo, il sollevamento della parte anteriore e quindi un trasporto agevole.
- Quattro ruote ad alta portata:
- 2 girevoli, anteriori, Ø 150 mm
- 2 fisse, posteriori, Ø 170 mm.
- Piano di lavoro ricoperto in gomma antiolio 1300x800 mm con foro di scarico per la raccolta di liquidi in un piccolo serbatoio.
- Vano passante 720x250x1300 mm con piano ricoperto in PVC, chiuso frontalmente da antine a scomparsa.
- Chiusura centralizzata per cassetti e antine.
- 3 portafiacconi laterali integrati.
- Portacarta integrato
- Capacità di carico statico: kg 1800.
- Predisposizione per la collocazione di un piano di lavoro in legno multistrato (3000 S/PLM) da ordinare separatamente
- Possibilità di collocazione di una morsa 1599F/150. (da ordinare separatamente)

📦 200 kg

	📦	📄	🛞
C30S	1	030000100	
3000S/VI3T (C30S+5910VI/3T)	1	030000093	300
3000S/VG3T (C30S+5910VG/3T)	1	030000097	335
3000 /VI3 (C30S+5910VI3)	1	030000099	299

1800 kg

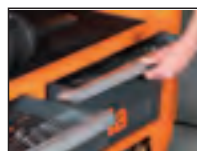

h	max
90 mm	30 kg
180 mm	35 kg

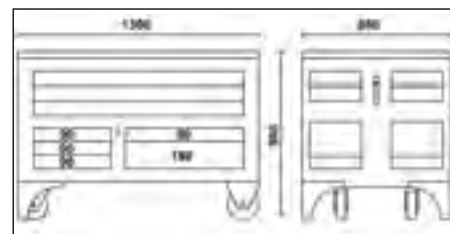

3000S/PLM

piano di lavoro in legno per C30S
con fori per la collocazione di una morsa 1599F/150

📦 10 kg

3000 S/PLM	1	030000150
------------	---	-----------



1240x740x26 mm

C31

postazione di lavoro mobile
con ventotto cassetti

- Ventotto cassetti da 588x367 mm montati su guide telescopiche a sfera:
- 19 cassetti altezza 70 mm
- 7 cassetti altezza 140 mm
- 1 cassetto altezza 210 mm
- 1 cassetto altezza 280 mm
- Frontalino del cassetto in alluminio
- Piano dei cassetti protetto da tappetini di gomma espansa
- Robusto piano di lavoro in legno multistrato
- Quattro serrature centralizzate
- Otto ruote Ø 125 mm, 2 fisse e 6 girevoli (2 con freno)

250 kg

2000
kg



C31 O



C31 R



C31 G

h	max
70 mm	30 kg
140 mm	35 kg
210 mm	35 kg

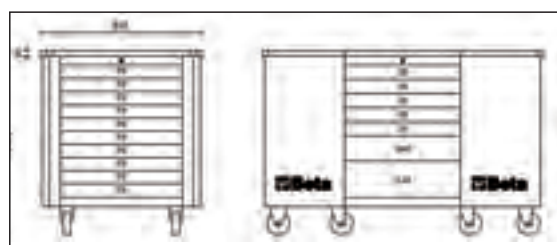
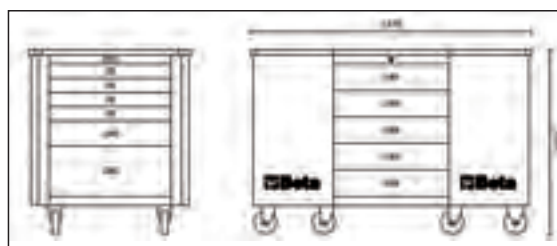

C31 O	1	031000281
C31 G	1	031000282
C31 R	1	031000283

C38 - 3800

cassettiera mobile
con undici cassetti

Caratteristiche principali:

- Undici cassetti montati su guide telescopiche a sfera:
- 1 cassetto 937x410x122 mm
- 3 cassetti 570x410x74 mm
- 2 cassetti 570x410x153 mm
- 3 cassetti 313x410x74 mm
- 2 cassetti 313x410x153 mm.
- Piano dei cassetti protetto da tappetini di gomma espansa.
- Capacità di carico statico: 1200 kg.
- 4 ruote ad alta portata Ø 125 mm: 2 fisse e 2 girevoli (entrambe con freno a leva).
- Serratura centralizzata frontale.
- Piano di lavoro di lamiera ricoperto da tappetino in gomma.
- Possibilità di applicazione del portacarta 2499PC e del portaflaconi 2499PF.

**1200
kg**



C38 O

114 kg



C38 G



C38 R

h	max
74 mm	25 kg
153 mm	30 kg

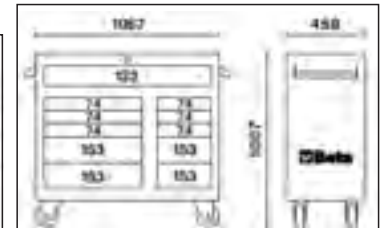
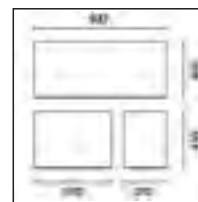

Model	Accessories	Qty	Part No.	Price
C38 O		1	038000001	
3800 O/U2T	(C38 O+5938U/2T)	1	038000068	315
C38 G		1	038000003	
3800 G/U2T	(C38 G+5938U/2T)	1	038000069	315
C38 R		1	038000002	
3800 R/U2T	(C38 R+5938U/2T)	1	038000070	315

Beta

C38L

cassettiera laterale
con sette cassetti

Caratteristiche principali:

- Sette cassetti da 410x313 mm, montati su guide telescopiche a sfera:
- 5 cassetti altezza 74 mm
- 2 cassetti altezza 153 mm.
- Piano dei cassetti protetto da tappetini di gomma espansa.
- Serratura di sicurezza centralizzata frontale.
- Piano di lavoro in alluminio antiscivolo.
- Agganciabile su entrambi i lati di C38 e C38A.

45 kg

C38L O	1	038000081
C38L G	1	038000083
C38L R	1	038000082



C38L O



C38L G



C38L R

h	max
74 mm	25 kg
153 mm	30 kg

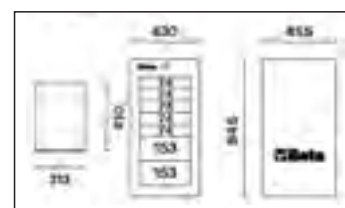

C38L A

antina laterale
con scaffale interno

Caratteristiche principali:

- Serratura frontale.
- Scaffale interno regolabile in altezza.
- Tasca portadocumenti posizionata all'interno dell'antina.
- Piano di lavoro in alluminio antiscivolo.
- Agganciabile su entrambi i lati di C38 e C38A.

18 kg

C38LA-O	1	038000071
C38LA-G	1	038000073
C38LA-R	1	038000072



C38L A O



C38LA G



C38LA R



C38T

cassettiera top
con otto cassetti e vano portautensili

Caratteristiche principali:

- Otto cassetti montati su guide telescopiche a sfera:
- 3 cassetti 570x410x74 mm
- 1 cassetto 570x410x153 mm
- 3 cassetti 313x410x74 mm
- 1 cassetto 313x410x153 mm.
- Vano portautensili.
- Piano dei cassetti protetto da tappetini di gomma espansa.
- Serratura di sicurezza centralizzata frontale.
- Collocabile sul piano di lavoro di C38 e C38A.

64 kg

C38T O	1	038000091
C38T G	1	038000093
C38T R	1	038000092



C38T O



C38T G



C38T R

h	max
74 mm	25 kg
153 mm	30 kg

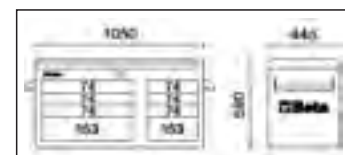

C38C

cassettiera mobile con trentatre cassetti
composta da:

- 1 cassetiera mobile C38
- 2 cassette laterali C38L
- 1 cassetiera top C38T

📦 268 kg

C38C O



h	max
74 mm	25 kg
153 mm	30 kg



C38C G



C38C R

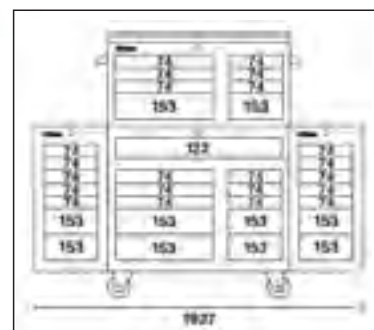
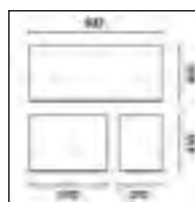

C38C O	1	038000201
C38C G	1	038000203
C38C R	1	038000202

C41MS

modulo superiore con portaminuterie integrato per trolley C41

3 kg

C41MS

1 041000904



495x250x225 mm

C41H/CE

cassetta portautensili con separatori estraibili per minuterie, in materiale plastico per trolley C41H

1,3 kg

C41H/CE

1 041000916



C42 MCH

Modulo centrale aggiuntivo per trolley C42

2,5 kg

C42 MCH

1 042000105



440x180x275 mm

 **Beta**

C51

carrello

- 3 ripiani ricoperti in gomma millerighe antiscivolo
- Maniglia ergonomica
- Doppia possibilità di fissaggio del ripiano centrale
- Quattro ruote Ø 100 mm:
2 fisse e 2 girevoli (una con freno).
- Capacità di carico statico: 200 kg. (distribuita sui 3 ripiani)

21 kg

C51/O	1	051000001
C51/G	1	051000002
C51/R	1	051000003



CP51

carrello ad alta resistenza

- 2 ripiani ricoperti da tappetini in gomma
- Maniglia ergonomica
- Quattro ruote Ø 125 mm ad alta resistenza:
2 fisse e 2 girevoli (una con freno).
- Capacità di carico statico: 750 kg. (distribuita sui 2 ripiani)

37 kg

CP51/O	1	051000501
CP51/G	1	051000502
CP51/R	1	051000503



C53 - 5300

armadietti CargoEvolution

Sono realizzati sulla base di accurate ricerche presso qualificati utilizzatori professionali ed offrono le soluzioni ideali per operare in modo confortevole e razionale.



L'apertura dei pannelli forati delle due antine permette lo sfruttamento anche della loro superficie interna.

Caratteristiche principali:

- 1 cassetto montato su guide telescopiche.
- Possibilità di modificare facilmente la disposizione degli utensili in funzione delle proprie esigenze.
- Posizionamento a parete per mezzo di due asole situate posteriormente.
- Serratura per chiusura contemporanea di antine e cassetto.
- Termoformato vuoto per bussole e accessori da 1/2".
- Le versioni VI e VG differiscono per il diverso allestimento dei supporti portautensili e sono forniti con ganci e supporti (senza utensili).

41 kg



			
C53	1	053000001	
C53VI	1	053000090	
5300VI (C53VI+5953VI)	1	053000015	301
C53VG	1	053000095	
5300VG (C53VG+5953VG)	1	053000025	337

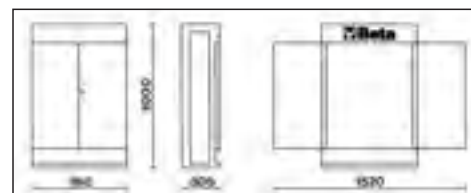

 **Beta**

C54 - 5400

armadietti NewCargo

Caratteristiche simili all'articolo C53.

- Termoformato vuoto per bussole e accessori da 1/2".
- Antine utilizzabili solo da un lato.
- Le versioni VI e VG differiscono per il diverso allestimento dei supporti portautensili e sono forniti con ganci e supporti (senza utensili).

33 kg



5400 O



C54 O



C54 G



C54 R

C54 O	1	054000001	
C54VI O	1	054000090	
5400 O/VI (C54VI O+5954VI)	1	054000150	302
C54VG O	1	054000095	
5400 O/VG (C54VG O+5954VG)	1	054000160	338
C54 G	1	054000002	
C54VI G	1	054000092	
5400 G/VI (C54VI G+5954VI)	1	054000152	302
C54VG G	1	054000097	
5400 G/VG (C54VG G+5954VG)	1	054000162	338
C54 R	1	054000003	
C54VI R	1	054000093	
5400 R/VI (C54VI R+5954VI)	1	054000154	302
C54VG R	1	054000098	
5400 R/VG (C54VG R+5954VG)	1	054000164	338



359

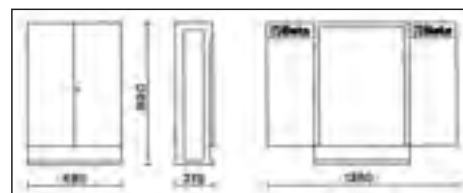

C57S A - 5700SA

banco da lavoro MasterCargo

- Modello con parete portautensili (C57P) e una cassetiera.

Cassetiera formata da cinque cassetti da 367x588 mm di cui 3 altezza 90 mm, 1 altezza 180 mm e 1 altezza 280 mm montati su guide telescopiche a sfera.

Predisposizione per l'inserimento di termoformati
Serratura centralizzata.

Parete portautensili anche appendibile mediante asole.

Tapparella in alluminio, manovrabile verticalmente, con serratura.

Tre pannelli forati amovibili per il sostegno degli utensili.

Piano di lavoro in legno multistrato, rivestito in laminato plastico con tre fori per la collocazione di una morsa 1599F/150 da ordinare separatamente.

205 kg



1800 kg

C57S A O



C57S A G



C57S A R



5700S A O

C57S A/O	1	057001005	
5700 AO/VI (C57S A/O+5957VI)	1	057001091	303
5700 AO/VG (C57S A/O+5957VG)	1	057001092	339
C57S A/G	1	057001205	
5700 AG/VI (C57S A/G+5957VI)	1	057001291	303
5700 AG/VG (C57S A/G+5957VG)	1	057001292	339
C57S A/R	1	057001405	
5700 AR/VI (C57S A/R+5957VI)	1	057001491	303
5700 AR/VG (C57S A/R+5957VG)	1	057001492	339



h	max
90 mm	30 kg
180 mm	40 kg
280 mm	40 kg

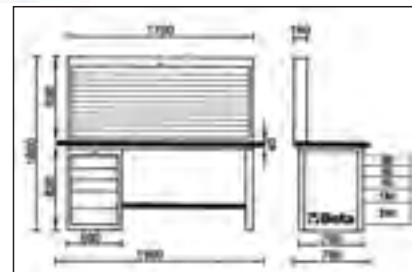

C57S D

banco da lavoro MasteraCargo

- Modello con una cassetiera

Cassetiera formata da cinque cassetti da 367x588 mm di cui 3 altezza 90 mm, 1 altezza 180 mm e 1 altezza 280 mm montati su guide telescopiche a sfera.

Predisposizione per l'inserimento di termoformati
Serratura centralizzata.

Piano di lavoro in legno multistrato, rivestito in laminato plastico con tre fori per la collocazione di una morsa 1599F/150 da ordinare separatamente.

158 kg



1800 kg

C57S D O



h	max
90 mm	30 kg
180 mm	40 kg
280 mm	40 kg



C57S D G



C57S D R

C57S D/O	1	057001004
C57S D/G	1	057001204
C57S D/R	1	057001404

C57S B - 5700SB

banco da lavoro MasterCargo

- Modello con parete portautensili (C57P) e due cassettiere.

Cassettiera formata da cinque cassetti da 367x588 mm di cui 3 altezza 90 mm, 1 altezza 180 mm e 1 altezza 280 mm montati su guide telescopiche a sfera.

Predisposizione per l'inserimento di termoformati
Serratura centralizzata.

Parete portautensili anche appendibile mediante asole.

Tapparella in alluminio, manovrabile verticalmente, con serratura.

Tre pannelli forati amovibili per il sostegno degli utensili.

Piano di lavoro in legno multistrato, rivestito in laminato plastico con tre fori per la collocazione di una morsa 1599F/150 da ordinare separatamente.

📦 243 kg

C57S B/O	1	057001006	
5700 BO/VI (C57S B/O+5957VI)	1	057001093	303
5700 BO/VG (C57S B/O+5957VG)	1	057001094	339
C57S B/G	1	057001206	
5700 BG/VI (C57S B/G+5957VI)	1	057001293	303
5700 BG/VG (C57S B/G+5957VG)	1	057001294	339
C57S B/R	1	057001406	
5700 BR/VI (C57S B/R+5957VI)	1	057001493	303
5700 BR/VG (C57S B/R+5957VG)	1	057001494	339



C57S B O



C57S B G



C57S B R



5700S B O



h	max
90 mm	30 kg
180 mm	40 kg
280 mm	40 kg

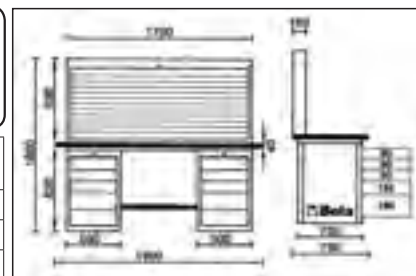

C57S C

banco da lavoro MasterCargo

- Modello con due cassettiere.

Cassettiera formata da cinque cassetti da 367x588 mm di cui 3 altezza 90 mm, 1 altezza 180 mm e 1 altezza 280 mm montati su guide telescopiche a sfera.

Predisposizione per l'inserimento di termoformati
Serratura centralizzata.

Piano di lavoro in legno multistrato, rivestito in laminato plastico con tre fori per la collocazione di una morsa 1599F/150 da ordinare separatamente.

📦 196 kg

C57S C/O	1	057001003	
C57S C/G	1	057001203	
C57S C/R	1	057001403	



C57S D O



h	max
90 mm	30 kg
180 mm	40 kg
280 mm	40 kg



C57S D G

C57S D R

C57SP - 5700SP

parete portautensili MasterCargo

- Parete portautensili anche appendibile mediante asole.
- Tapparella in alluminio, manovrabile verticalmente, con serratura.
- Tre pannelli forati amovibili per il sostegno degli utensili.

📦 46 kg



C57SP O

1700 mm

930 mm



C57P G



5700SP O/U



359



C57SP R

C57SP O		1	057001020	
5700SP O/U	(C57SP O+5957U)	1	057001075	317
C57SP G		1	057001220	
5700SP G/U	(C57SP G+5957U)	1	057001275	317
C57SP R		1	057001420	
5700SP R/U	(C57SP R+5957U)	1	057001475	317

5700LAMP

lampada per banco MasterCargo

- Robusta struttura in lamiera composta da quattro elementi; completa di viti per l'assemblaggio.
- Portalamпада con tubo fluorescente da 36W.
- Alimentazione 230V.
- Fornito senza cavo.

📦 9 kg



5700LAMP + 5700SA O

5700LAMP

📦 1 057000005

C58P - 5800P

parete portautensili

- Soluzione con chiusura a tapparella in alluminio verniciato e serratura di chiusura.
- Due pannelli forati amovibili per il sostegno degli utensili.

 31 kg



C58P O

1140 mm

930 mm



C58P G





5800UP/O



C58P R



359

Model	Accessories	Qty	Part No.	Price
C58P/O	 	1	058000121	
5800 P-O	(C58P O+5958U)	1	058000181	318
C58P/G		1	058000122	
5800 P-G	(C58P G+5958U)	1	058000182	318
C58P/R		1	058000123	
5800 P-R	(C58P R+5958U)	1	058000183	318

PV

pannello portautensili da parete

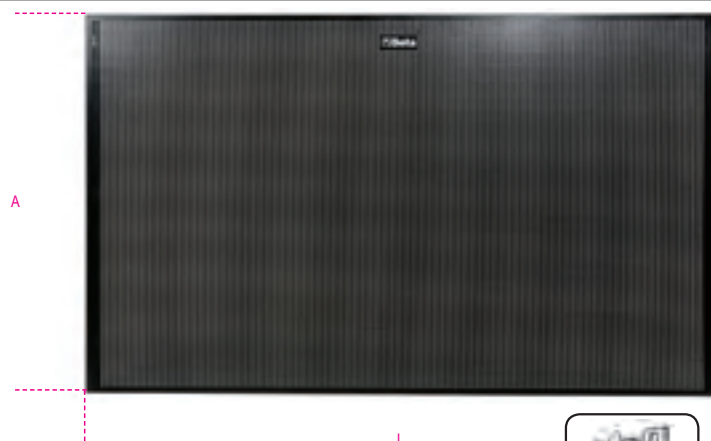

A

L



359

Model	LxA mm	Weight kg	Qty	Part No.
PV 1	1000x920	10,2	1	088880010
PV 1,5	1500x920	14,2	1	088880015



C41MS

modulo superiore con portaminuterie integrato per trolley C41

3 kg

C41MS

1 041000904



495x250x225 mm

C41H/CE

cassetta portautensili con separatori estraibili per minuterie, in materiale plastico per trolley C41H

1,3 kg

C41H/CE

1 041000916



C42 MCH

Modulo centrale aggiuntivo per trolley C42

2,5 kg

C42 MCH

1 042000105



440x180x275 mm

Beta

The image shows the Beta logo in orange and black, set against a background of a technical drawing on a grid. The drawing includes various lines, angles (15°), and labels (S1, L, L1, A, B). The Beta logo is prominently displayed in the center.

C51

carrello

- 3 ripiani ricoperti in gomma millerighe antiscivolo
- Maniglia ergonomica
- Doppia possibilità di fissaggio del ripiano centrale
- Quattro ruote Ø 100 mm:
2 fisse e 2 girevoli (una con freno).
- Capacità di carico statico: 200 kg. (distribuita sui 3 ripiani)

21 kg

C51/O	1	051000001
C51/G	1	051000002
C51/R	1	051000003



CP51

carrello ad alta resistenza

- 2 ripiani ricoperti da tappetini in gomma
- Maniglia ergonomica
- Quattro ruote Ø 125 mm ad alta resistenza:
2 fisse e 2 girevoli (una con freno).
- Capacità di carico statico: 750 kg. (distribuita sui 2 ripiani)

37 kg

CP51/O	1	051000501
CP51/G	1	051000502
CP51/R	1	051000503



C53 - 5300

armadietti CargoEvolution

Sono realizzati sulla base di accurate ricerche presso qualificati utilizzatori professionali ed offrono le soluzioni ideali per operare in modo confortevole e razionale.



L'apertura dei pannelli forati delle due antine permette lo sfruttamento anche della loro superficie interna.

Caratteristiche principali:

- 1 cassetto montato su guide telescopiche.
- Possibilità di modificare facilmente la disposizione degli utensili in funzione delle proprie esigenze.
- Posizionamento a parete per mezzo di due asole situate posteriormente.
- Serratura per chiusura contemporanea di antine e cassetto.
- Termoformato vuoto per bussole e accessori da 1/2".
- Le versioni VI e VG differiscono per il diverso allestimento dei supporti portautensili e sono forniti con ganci e supporti (senza utensili).

41 kg



			
C53	1	053000001	
C53VI	1	053000090	
5300VI (C53VI+5953VI)	1	053000015	301
C53VG	1	053000095	
5300VG (C53VG+5953VG)	1	053000025	337

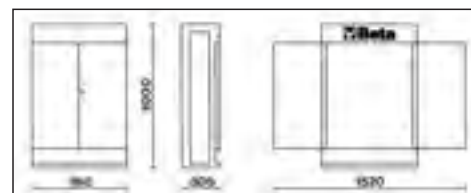

C54 - 5400

armadietti NewCargo

Caratteristiche simili all'articolo C53.

- Termoformato vuoto per bussole e accessori da 1/2".
- Antine utilizzabili solo da un lato.
- Le versioni VI e VG differiscono per il diverso allestimento dei supporti portautensili e sono forniti con ganci e supporti (senza utensili).

33 kg



5400 O

C54 O	1	054000001	
C54VI O	1	054000090	
5400 O/VI (C54VI O+5954VI)	1	054000150	302
C54VG O	1	054000095	
5400 O/VG (C54VG O+5954VG)	1	054000160	338
C54 G	1	054000002	
C54VI G	1	054000092	
5400 G/VI (C54VI G+5954VI)	1	054000152	302
C54VG G	1	054000097	
5400 G/VG (C54VG G+5954VG)	1	054000162	338
C54 R	1	054000003	
C54VI R	1	054000093	
5400 R/VI (C54VI R+5954VI)	1	054000154	302
C54VG R	1	054000098	
5400 R/VG (C54VG R+5954VG)	1	054000164	338



C54 O



C54 G



C54 R



359

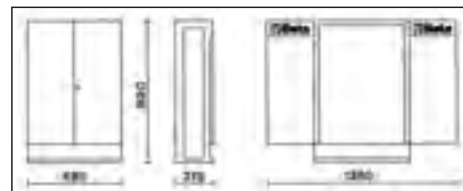

C57S A - 5700SA

banco da lavoro MasterCargo

- Modello con parete portautensili (C57P) e una cassetiera.

Cassetiera formata da cinque cassetti da 367x588 mm di cui 3 altezza 90 mm, 1 altezza 180 mm e 1 altezza 280 mm montati su guide telescopiche a sfera.

Predisposizione per l'inserimento di termoformati
Serratura centralizzata.

Parete portautensili anche appendibile mediante asole.

Tapparella in alluminio, manovrabile verticalmente, con serratura.

Tre pannelli forati amovibili per il sostegno degli utensili.

Piano di lavoro in legno multistrato, rivestito in laminato plastico con tre fori per la collocazione di una morsa 1599F/150 da ordinare separatamente.

📦 205 kg



1800 kg

C57S A O



C57S A G



C57S A R



5700S A O

Modello	Quantità	Articolo	Prezzo
C57S A/O	1	057001005	
5700 AO/VI (C57S A/O+5957VI)	1	057001091	303
5700 AO/IVG (C57S A/O+5957VG)	1	057001092	339
C57S A/G	1	057001205	
5700 AG/VI (C57S A/G+5957VI)	1	057001291	303
5700 AG/IVG (C57S A/G+5957VG)	1	057001292	339
C57S A/R	1	057001405	
5700 AR/VI (C57S A/R+5957VI)	1	057001491	303
5700 AR/IVG (C57S A/R+5957VG)	1	057001492	339



h	max
90 mm	30 kg
180 mm	40 kg
280 mm	40 kg

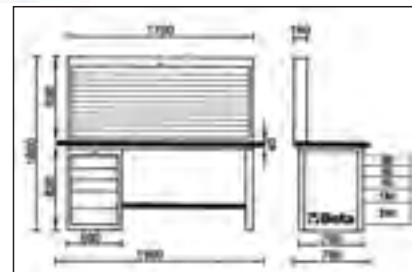

C57S D

banco da lavoro MasteraCargo

- Modello con una cassetiera

Cassetiera formata da cinque cassetti da 367x588 mm di cui 3 altezza 90 mm, 1 altezza 180 mm e 1 altezza 280 mm montati su guide telescopiche a sfera.

Predisposizione per l'inserimento di termoformati
Serratura centralizzata.

Piano di lavoro in legno multistrato, rivestito in laminato plastico con tre fori per la collocazione di una morsa 1599F/150 da ordinare separatamente.

📦 158 kg



1800 kg

C57S D O



h	max
90 mm	30 kg
180 mm	40 kg
280 mm	40 kg



C57S D G



C57S D R

C57S D/O	1	057001004
C57S D/G	1	057001204
C57S D/R	1	057001404

C57S B - 5700SB

banco da lavoro MasterCargo

- Modello con parete portautensili (C57P) e due cassettiere.

Cassettiera formata da cinque cassetti da 367x588 mm di cui 3 altezza 90 mm, 1 altezza 180 mm e 1 altezza 280 mm montati su guide telescopiche a sfera.

Predisposizione per l'inserimento di termoformati Serratura centralizzata.

Parete portautensili anche appendibile mediante asole.

Tapparella in alluminio, manovrabile verticalmente, con serratura.

Tre pannelli forati amovibili per il sostegno degli utensili.

Piano di lavoro in legno multistrato, rivestito in laminato plastico con tre fori per la collocazione di una morsa 1599F/150 da ordinare separatamente.

📦 243 kg

Modello	Accessori	Quantità	Articolo	Prezzo
C57S B/O		1	057001006	
5700 BO/VI	(C57S B/O+5957VI)	1	057001093	303
5700 BO/VG	(C57S B/O+5957VG)	1	057001094	339
C57S B/G		1	057001206	
5700 BG/VI	(C57S B/G+5957VI)	1	057001293	303
5700 BG/VG	(C57S B/G+5957VG)	1	057001294	339
C57S B/R		1	057001406	
5700 BR/VI	(C57S B/R+5957VI)	1	057001493	303
5700 BR/VG	(C57S B/R+5957VG)	1	057001494	339



C57S B O



C57S B G



C57S B R



5700S B O



h	max
90 mm	30 kg
180 mm	40 kg
280 mm	40 kg

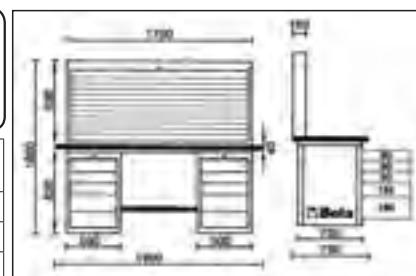

C57S C

banco da lavoro MasterCargo

- Modello con due cassettiere.

Cassettiera formata da cinque cassetti da 367x588 mm di cui 3 altezza 90 mm, 1 altezza 180 mm e 1 altezza 280 mm montati su guide telescopiche a sfera.

Predisposizione per l'inserimento di termoformati Serratura centralizzata.

Piano di lavoro in legno multistrato, rivestito in laminato plastico con tre fori per la collocazione di una morsa 1599F/150 da ordinare separatamente.

📦 196 kg

Modello	Accessori	Quantità	Articolo	Prezzo
C57S C/O		1	057001003	
C57S C/G		1	057001203	
C57S C/R		1	057001403	



C57S D O



h	max
90 mm	30 kg
180 mm	40 kg
280 mm	40 kg



C57S D G

C57S D R

C57SP - 5700SP

parete portautensili MasterCargo

- Parete portautensili anche appendibile mediante asole.
- Tapparella in alluminio, manovrabile verticalmente, con serratura.
- Tre pannelli forati amovibili per il sostegno degli utensili.

46 kg



C57SP O

1700 mm

930 mm



C57P G



5700SP O/U



359



C57SP R

C57SP O		1	057001020	
5700SP O/U	(C57SP O+5957U)	1	057001075	317
C57SP G		1	057001220	
5700SP G/U	(C57SP G+5957U)	1	057001275	317
C57SP R		1	057001420	
5700SP R/U	(C57SP R+5957U)	1	057001475	317

5700LAMP

lampada per banco MasterCargo

- Robusta struttura in lamiera composta da quattro elementi; completa di viti per l'assemblaggio.
- Portalamпада con tubo fluorescente da 36W.
- Alimentazione 230V.
- Fornito senza cavo.

9 kg



5700LAMP + 5700SA O

5700LAMP

1 057000005

C58P - 5800P

parete portautensili

- Soluzione con chiusura a tapparella in alluminio verniciato e serratura di chiusura.
- Due pannelli forati amovibili per il sostegno degli utensili.

31 kg



C58P O

1140 mm

930 mm



C58P G



5800UP/O



C58P R



359

Model	Accessories	Qty	Part No.	Weight (kg)
C58P/O		1	058000121	
5800 P-O	(C58P O+5958U)	1	058000181	318
C58P/G		1	058000122	
5800 P-G	(C58P G+5958U)	1	058000182	318
C58P/R		1	058000123	
5800 P-R	(C58P R+5958U)	1	058000183	318

PV

pannello portautensili da parete

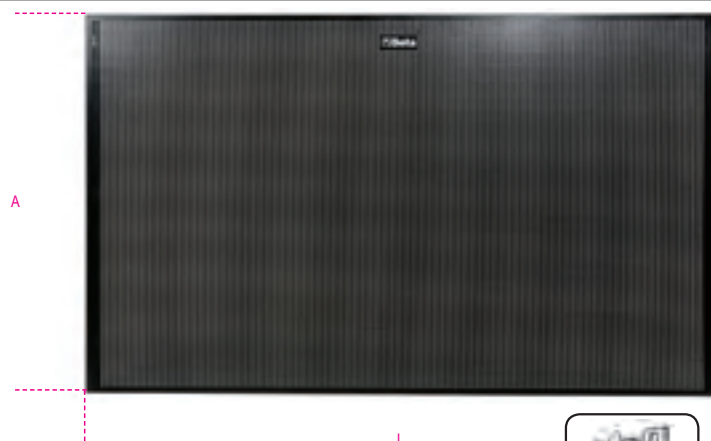

A

L



359

Model	LxA (mm)	Weight (kg)	Qty	Part No.
PV 1	1000x920	10,2	1	088880010
PV 1,5	1500x920	14,2	1	088880015

 **Beta**

C56W

banco da lavoro con piano di lavoro in legno

- Piano di lavoro in legno multistrato (spessore 30 mm)
- Struttura in acciaio con 6 gambe di sostegno
- Capacità di carico statico: 1.200 kg
- Abbinabile alla parete C57P (non fissabile al piano di lavoro).
- Due cassetti dotati di serratura.
- Predisposizione per il fissaggio al pavimento.

86 kg



C56W O	1	056000251
C56W G	1	056000252
C56W R	1	056000253

C56

banco da lavoro

- Piano di lavoro in lamiera verniciata con bordo perimetrale
- Struttura in acciaio con 6 gambe di sostegno
- Capacità di carico statico: 1.200 kg
- Abbinabile alla parete C57P non fissabile al piano di lavoro.
- Due cassetti dotati di serratura.
- Predisposizione per il fissaggio al pavimento.

82 kg



C56 O	1	056000201
C56 G	1	056000202
C56 R	1	056000203

C56M

banco da lavoro

- Piano di lavoro in metallo rivestito per metà da lastra in alluminio antiscivolo e per metà da tappeto in gomma asportabile.
- Sottopiano in massello di legno.
- Capacità di carico statico: 800 kg
- Abbinabile alla parete C57P non fissabile al piano di lavoro.
- Tre cassetti dotati di serratura.
- Predisposizione per il fissaggio al pavimento.

95 kg



C56M O	1	056000050
C56M G	1	056000053
C56M R	1	056000054

C58M

banco da lavoro

- Piano di lavoro in metallo interamente rivestito da un tappetino in gomma antiscivolo asportabile.
- Sottopiano in massello di legno.
- Capacità di carico statico: 800 kg.
- Abbinabile alla parete C58P non fissabile al piano di lavoro.
- 2 cassetti dotati di serratura.
- Predisposizione per il fissaggio al pavimento.
- Possibilità di applicazione opzionale del piano di lavoro in alluminio C58M/PA.

800 kg



65 kg

C58M O	1	058000300
C58M G	1	058000302
C58M R	1	058000303

C58M/PA

piano in alluminio godronato per banco da lavoro C58M

4,5 kg



C58M/PA	1	058000350
---------	---	-----------

C59A - 5900A

banco da lavoro "Endurance" con 1 cassetiera da sei cassetti

Caratteristiche principali:

- Ripiano in legno multistrato con fori per la collocazione di una morsa 1599F/125 (da ordinare separatamente).
- 6 cassetti 588x367 mm, montati su guide telescopiche a sfera:
 - 4 cassetti altezza 70 mm
 - 1 cassetto altezza 140 mm
 - 1 cassetto altezza 280 mm
- Piano dei cassetti protetto da tappetini di gomma espansa.
- Frontalino dei cassetti in Nylon ad alta resistenza.
- Cassettiere predisposte per l'inserimento di termoformati.
- Serratura di sicurezza centralizzata frontale.
- Ripiano inferiore portaoggetti.
- predisposizione per portacarta (2400S-R/PC) e portaflaconi (2400S/PF) da ordinare separatamente.

115 kg

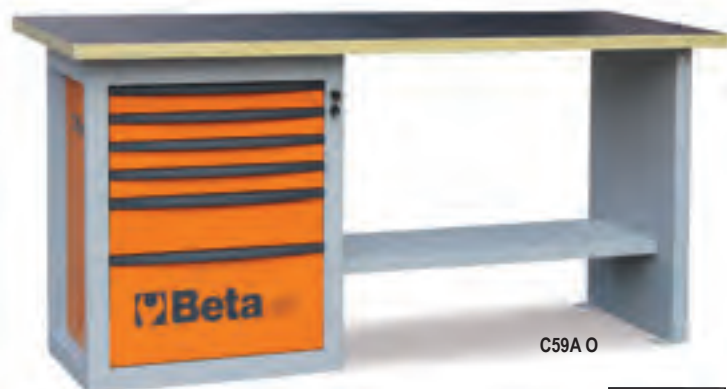

C59A O



C59A G

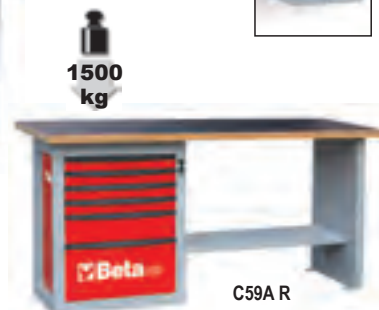

C59A R



1500 kg

h	max
70 mm	25 kg
140 mm	30 kg
280 mm	35 kg



C59A O	1	059000001
C59A G	1	059000021
C59A R	1	059000041

C59B - 5900B

banco da lavoro "Endurance" con 2 cassetiere da sei cassetti

Caratteristiche principali:

- Ripiano in legno multistrato con fori per la collocazione di una morsa 1599F/125 (da ordinare separatamente).
- 12 cassetti 588x367 mm, montati su guide telescopiche a sfera:
 - 8 cassetti altezza 70 mm
 - 2 cassetti altezza 140 mm
 - 2 cassetti altezza 280 mm
- Piano dei cassetti protetto da tappetini di gomma espansa.
- Possibilità di inserimento termoformati.
- Serratura di sicurezza centralizzata frontale.
- Ripiano inferiore portaoggetti.
- predisposizione per portacarta (2400S-R/PC) e portaflaconi (2400S/PF) da ordinare separatamente.

155 kg



C59B O



C59B G

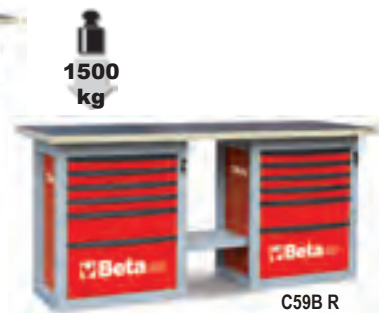

C59B R



h	max
70 mm	25 kg
140 mm	30 kg
280 mm	35 kg



C59B O	1	059000002
C59B G	1	059000022
C59B R	1	059000042

C59C - 5900C

banco da lavoro "Endurance" con 1 cassetiera da sei cassetti, modello corto

Caratteristiche principali:

- Ripiano in legno multistrato con fori per la collocazione di una morsa 1599F/125 (da ordinare separatamente).
- 6 cassetti 588x367 mm, montati su guide telescopiche a sfera:
 - 4 cassetti altezza 70 mm
 - 1 cassetto altezza 140 mm
 - 1 cassetto altezza 280 mm
- Piano dei cassetti protetto da tappetini di gomma espansa.
- Possibilità di inserimento termoformati.
- Serratura di sicurezza centralizzata frontale.
- Ripiano inferiore portaoggetti.
- predisposizione per portacarta (2400S-R/PC) e portaflaconi (2400S/PF) da ordinare separatamente.

105 kg



C59C O



C59C G



C59C R



h	max
70 mm	25 kg
140 mm	30 kg
280 mm	35 kg



C59C O	1	059000003
C59C G	1	059000023
C59C R	1	059000043

Beta

RSC 55



ARREDO OFFICINA

Beta Utensili, per rispondere alle esigenze di un mercato che sempre più ricerca qualità, design e personalizzazione, ha creato "Racing System C55": un arredo per officina modulare che vi offre la possibilità di creare un ambiente di lavoro moderno, modellato sulle vostre necessità.

Configura on-line la tua officina

Vai su www.beta-tools.it/RSC55

Modularità

Officina componibile in base ai vostri spazi e alle vostre esigenze

Qualità

La migliore qualità Beta
"Made in Italy" per arredare la tua officina

Organizzazione

Una postazione organizzata in maniera razionale consente di ottimizzare il lavoro

Design

Finiture ricercate ed accattivanti per rendere il posto di lavoro un ambiente ordinato e gradevole

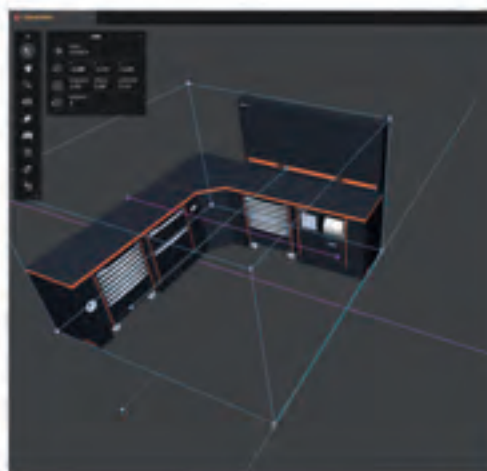
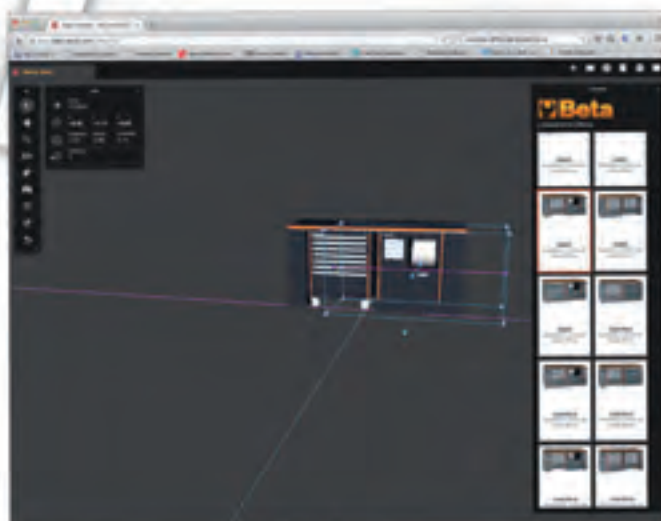
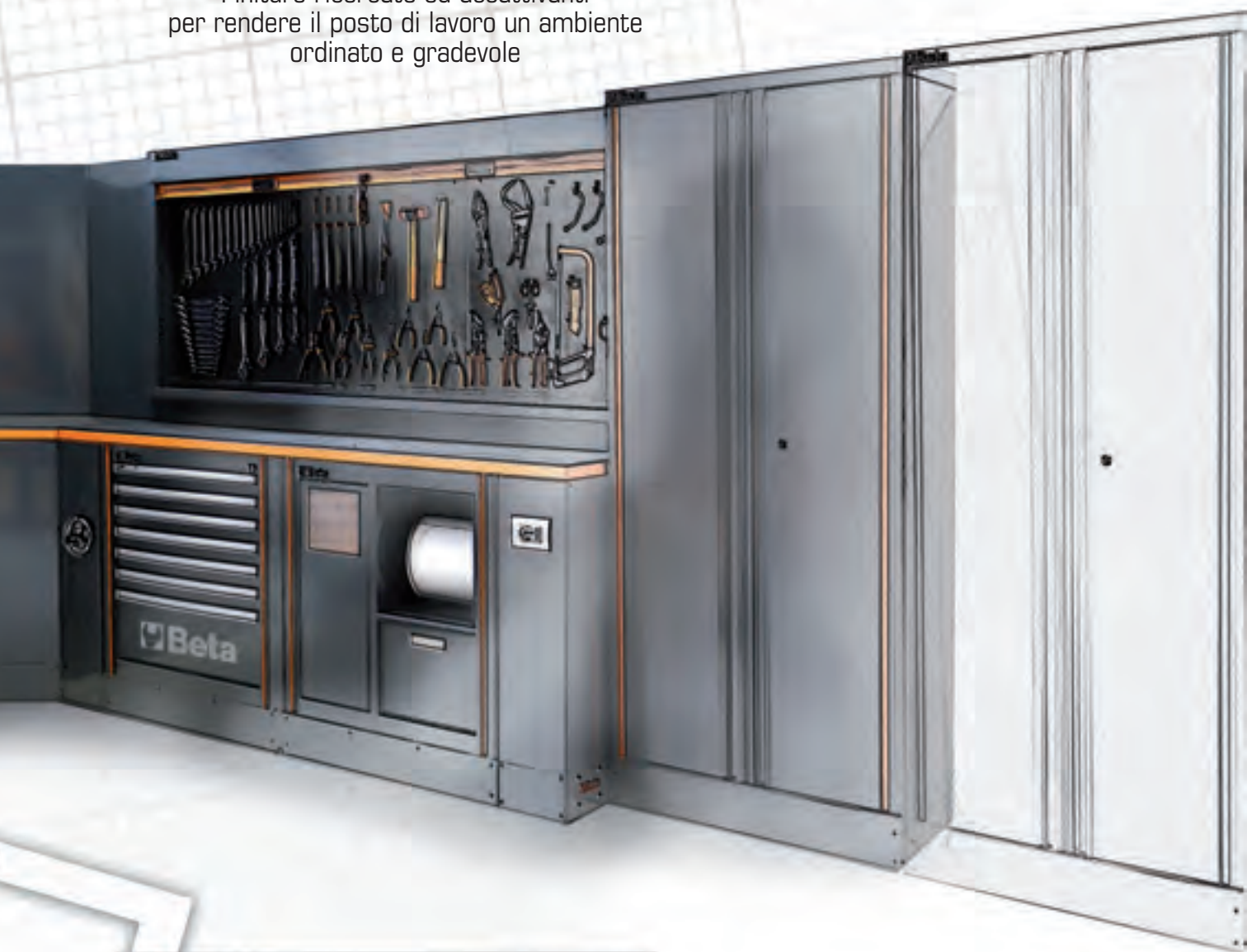

C55B

banco in lamiera per arredo officina

Con piano da lavoro 2050x700 mm rivestito da uno strato di ABS asportabile

- Fori per la collocazione di una morsa 1599F/150 (da ordinare separatamente)
- Piedini regolabili in altezza

📦 100 kg

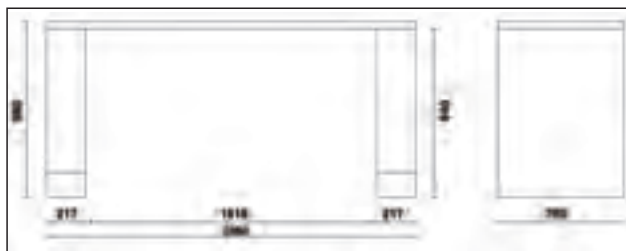

C55B

1 055000101

C55B-PRO

banco in lamiera per arredo officina

Con piano da lavoro 2050x700 mm rivestito da uno strato di ABS asportabile

Prese elettriche e arrotolatore integrati:

- Presa Schuko+16+10A
- Presa EU Plug 16+10A
- Presa per aria compressa con arrotolatore da Ø 8 mm. Lunghezza: 10 m
- Fori per la collocazione di una morsa 1599F/150 (da ordinare separatamente)

- Piedini regolabili in altezza

📦 105 kg



C55B-PRO

1 055000151

 **Beta**



C55M7

modulo fisso con sette cassetti per arredo officina

- 7 cassetti da 588x367 mm, montati su guide telescopiche asfera
- Sistema di apertura in alluminio posizionato su tutta la lunghezza del cassetto
- Piano dei cassetti protetto da tappetini digomma espansa
- Serratura centralizzata frontale
- Predisposizione per l'inserimento dei termoformati

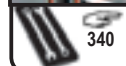
78 kg



 h	 max
70 mm	30 kg

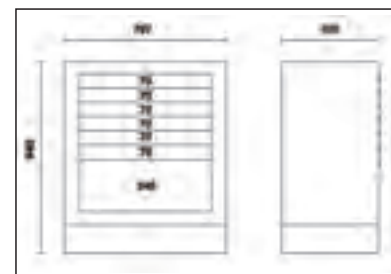

C55M7

1 055000203



C55C7

cassettiera mobile con sette cassetti per arredo officina

- 7 cassetti da 588x367 mm, montati su guide telescopiche a sfera
- 4 ruote Ø 100 mm, 2 fisse (una con freno) e 2 girevoli
- Sistema di apertura in alluminio posizionato su tutta la lunghezza del cassetto
- Piano dei cassetti protetto da tappetini di gomma espansa
- Serratura centralizzata frontale
- Predisposizione per l'inserimento dei termoformati

79 kg



 h	 max
70 mm	30 kg

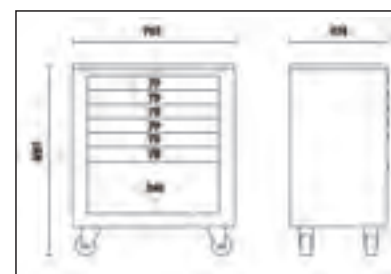

C55C7

1 055000201

C55M2

modulo fisso con due cassetti per arredo officina

- 2 cassetti da 588x367mm, montati su guide telescopiche a sfera
- Sistema di apertura in alluminio posizionato su tutta la lunghezza del cassetto
- Piano dei cassetti protetto da tappetini di gomma espansa
- Serratura centralizzata frontale

📦 66 kg



C55M2

📦 1 055000202

C55MS

modulo fisso di servizio per arredo officina

- Cestino portarifiuti integrato
- Vano portacarta per rotoli preforati
- Cassettone portaoggetti 305x270 mm

📦 75 kg

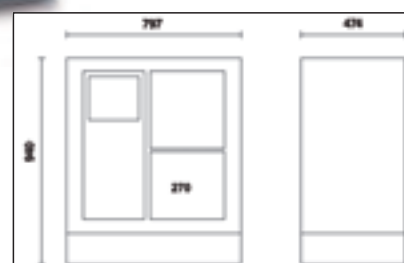

C55MS

📦 1 055000204

C55MA

modulo fisso con due antine per arredo officina

Ripiano interno regolabile in altezza

📦 75 kg

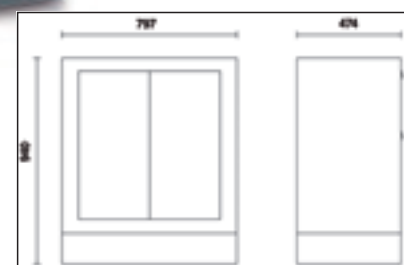

C55MA

📦 1 055000205

C55AN/K-P

angolo interno per arredo officina

30 kg

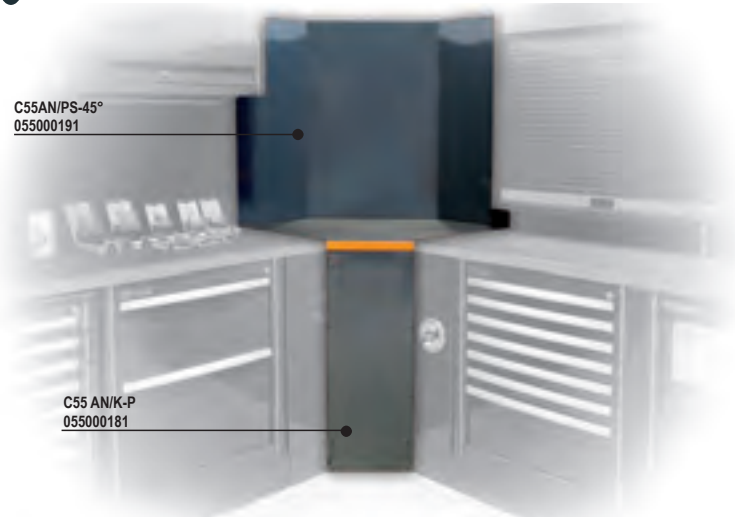

C55AN/K-P	1	055000181
C55AN/PS-45°	1	055000191

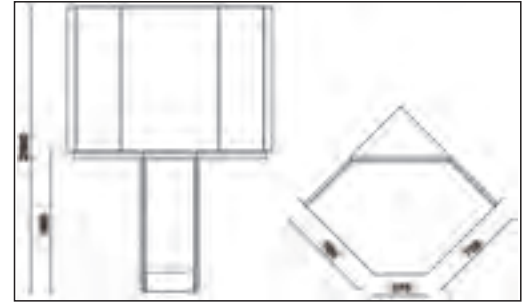

C55AN/K-PC

angolo interno per arredo officina, con vano portacarta

32 kg



C55AN/K-PC	1	055000182
C55AN/PS-45°	1	055000191

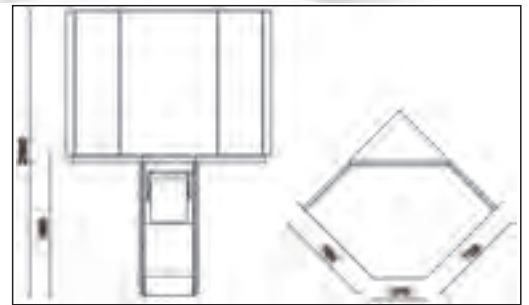

C55B/1

postazione di lavoro per arredo officina

Combinazione composta da:

- Banco da lavoro (C55 B)
- Modulo fisso con 2 cassette (C55 M2)
- Modulo fisso con 7 cassette (C55 M7)

246 kg

C55B/1

1 055000041

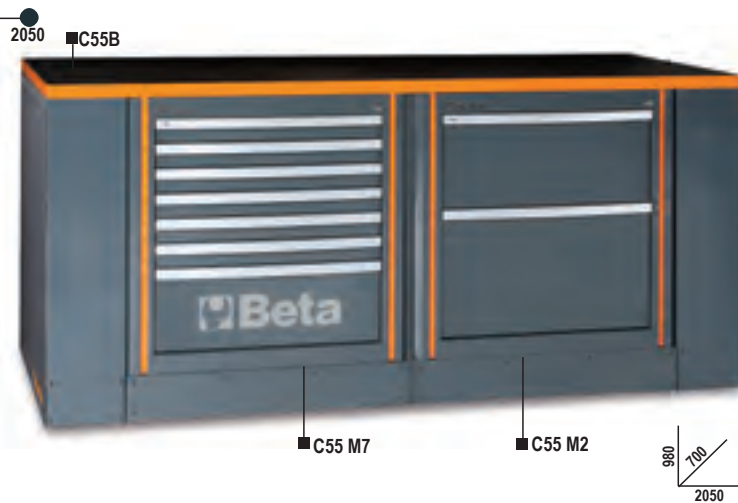

C55B-PRO/1

postazione di lavoro per arredo officina

Combinazione composta da:

- Banco da lavoro con prese (C55B-PRO)
- Modulo fisso con 2 cassette (C55 M2)
- Modulo fisso con 7 cassette (C55 M7)

251 kg

C55B-PRO/1

1 055000071

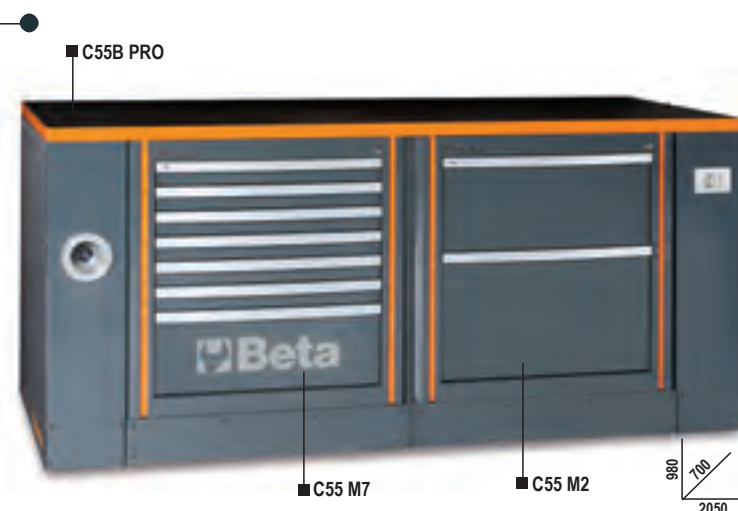

C55B/2

postazione di lavoro per arredo officina

Combinazione composta da:

- Banco da lavoro (C55 B)
- Modulo fisso con 7 cassette (C55 M7)
- Modulo fisso di servizio (C55 MS)

254 kg

C55B/2

1 055000042

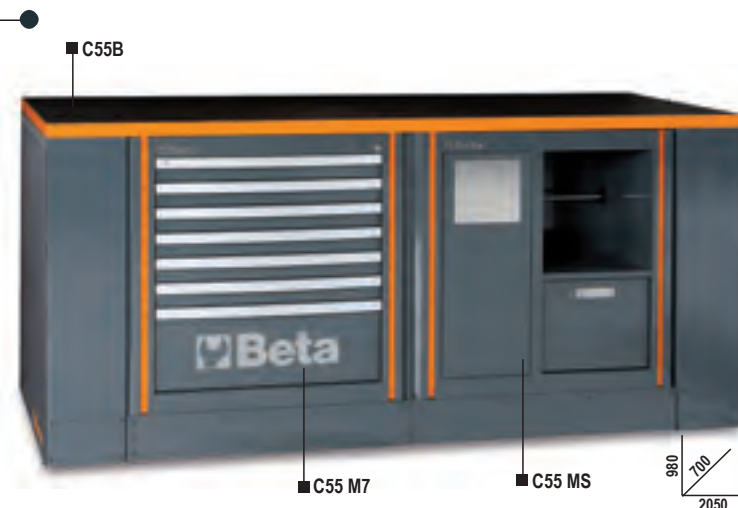

C55B-PRO/2

postazione di lavoro per arredo officina

Combinazione completa composta da:

- Banco da lavoro con prese (C55B-PRO)
- Modulo fisso con 7 cassette (C55 M7)
- Modulo fisso di servizio (C55 MS)

260 kg

C55B-PRO/2

1 055000072

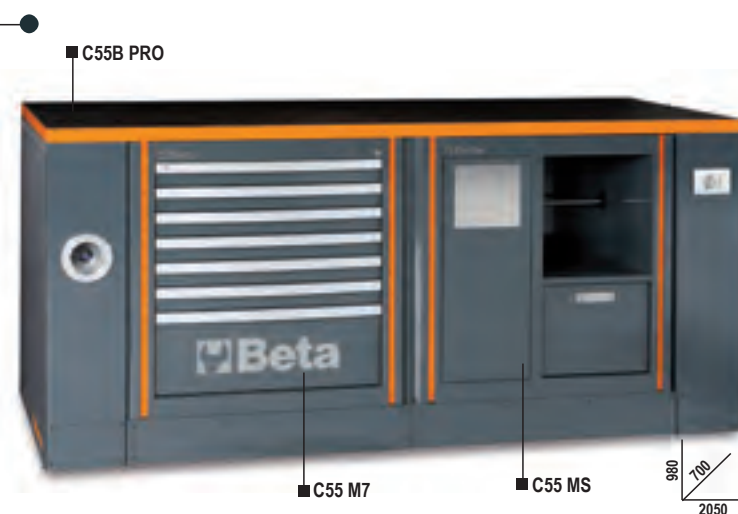

C55B/3

postazione di lavoro per arredo officina

Combinazione completa composta da:

- Banco da lavoro (C55 B)
- Cassetiera mobile con 7 cassetti (C55 C7)
- Modulo fisso con 2 cassettoni (C55 M2)

246 kg

C55B/3

1 055000043

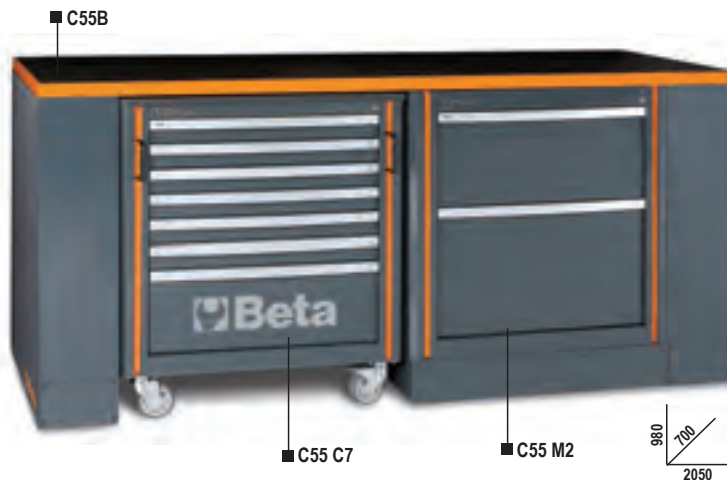

C55B-PRO/3

postazione di lavoro per arredo officina

Combinazione completa composta da:

- Banco da lavoro con prese (C55B-PRO)
- Cassetiera mobile con 7 cassetti (C55 C7)
- Modulo fisso con 2 cassettoni (C55 M2)

251 kg

C55B-PRO/3

1 055000073

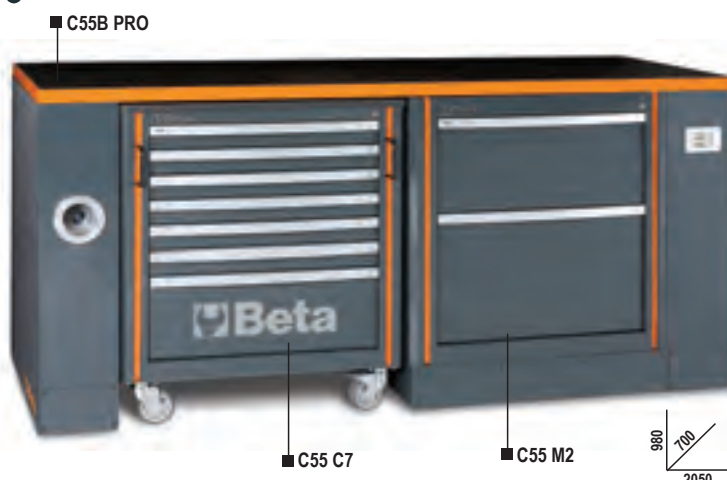

C55B/4

postazione di lavoro per arredo officina

Combinazione completa composta da:

- Banco da lavoro (C55 B)
- Cassetiera mobile con 7 cassetti (C55 C7)
- Modulo fisso di servizio (C55 MS)

255 kg

C55B/4

1 055000044



C55B-PRO/4

postazione di lavoro per arredo officina

Combinazione completa composta da:

- Banco da lavoro con prese (C55B-PRO)
- Cassetiera mobile con 7 cassetti (C55 C7)
- Modulo fisso di servizio (C55 MS)

260 kg

C55B-PRO/4

1 055000074

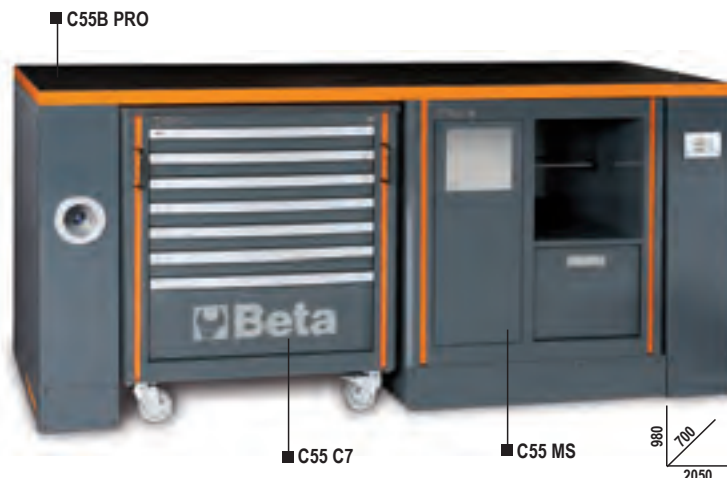

C55B/5

postazione di lavoro per arredo officina

- Combinazione completa composta da:
- Banco da lavoro (C55 B)
 - Cassettiera mobile con 7 cassetti (C55 C7)
 - Modulo fisso con 7 cassetti (C55 M7)

260 kg

C55B/5 1 055000045

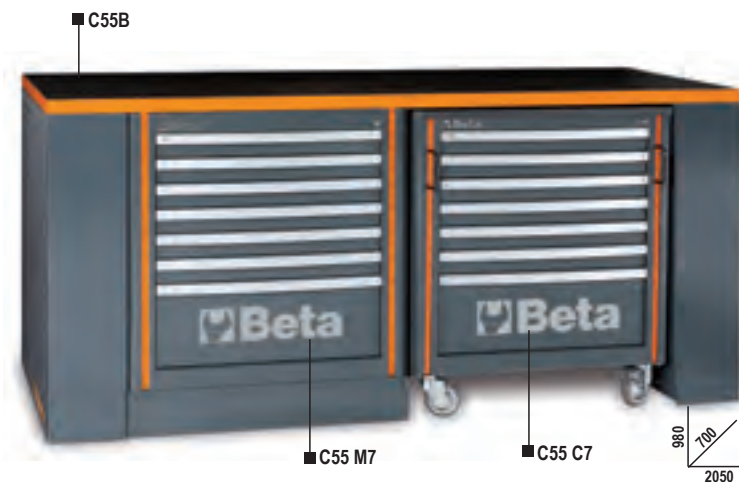

C55B-PRO/5

postazione di lavoro per arredo officina

- Combinazione completa composta da:
- Banco da lavoro con prese (C55B-PRO)
 - Cassettiera mobile con 7 cassetti (C55 C7)
 - Modulo fisso con 7 cassetti (C55 M7)

264 kg

C55B-PRO/5 1 055000075

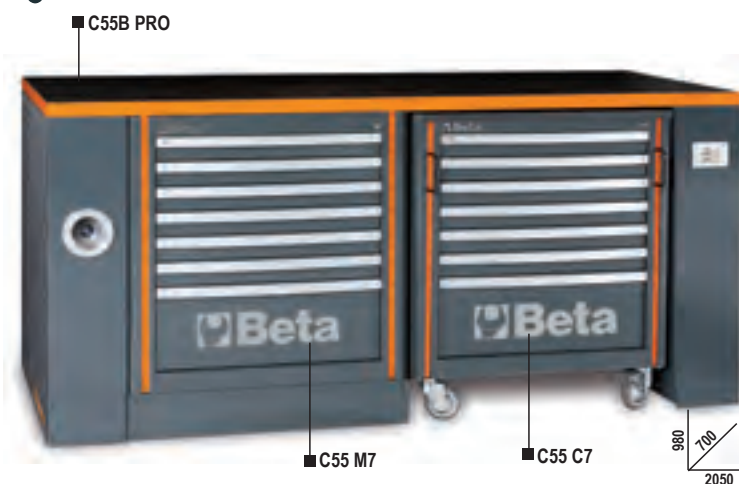

C55B/6

postazione di lavoro per arredo officina

- Combinazione completa composta da:
- Banco da lavoro (C55 B)
 - Modulo fisso con 2 cassettoni (C55 M2)
 - Modulo fisso di servizio (C55 MS)

242 kg

C55B/6 1 055000046



C55B-PRO/6

postazione di lavoro per arredo officina

- Combinazione completa composta da:
- Banco da lavoro con prese (C55B-PRO)
 - Modulo fisso con 2 cassettoni (C55 M2)
 - Modulo fisso di servizio (C55 MS)

247 kg

C55B-PRO/6 1 055000076



C55PSP

parete portautensili con tapparella e struttura portante per arredo officina

- Tapparella in alluminio, manovrabile verticalmente, con serratura
- Pannello forato amovibile per il sostegno degli utensili
- Fornita con struttura portante per essere abbinata ai banchi di lavoro C55B e C55B-PRO

📦 88 kg



C55PSP 1 055000250

C55P

parete portautensili con tapparella per arredo officina

- Tapparella in alluminio, manovrabile verticalmente, con serratura
- Pannello forato amovibile per il sostegno degli utensili

📦 61 kg



C55P 1 055000251

5955U 316

C55P/SP

struttura portante per parete portautensili C55 P

📦 15 kg



C55P/SP 1 055000252

C55 2PM

parete con pensili per arredo officina e struttura portante

- 2 pensili 1024x400x300 mm dotati di molle a gas per facilitare l'apertura e la chiusura delle ante.
- Pannello a muro 2050x620 mm con predisposizione per alloggiare pannelli forati portautensili C55 2PF (da ordinare separatamente)
- Fornita con struttura portante per essere abbinata ai banchi di lavoro C55B e C55B-PRO

80 kg

C552PM

1 055000301



C55LMP/1

lampada LED per arredo officina C55

- lunghezza: 1 m
- Pratico fissaggio sotto all'armadietto pensile tramite coppia di magneti
- Interruttore ON/OFF
- Cavo e trasformatore integrati da 18 Watt
- 1300 lumen

1,2 kg

C55LMP/1

1 055000320



C55LMP/2

2 lampade LED per arredo officina C55

- lunghezza: 2 lampade da 1 m ciascuna collegate tra loro
- Pratico fissaggio sotto all'armadietto pensile tramite coppia di magneti
- Interruttore ON/OFF
- Cavo e trasformatore integrati da 18 Watt
- 1300 lumen

2 kg

C55LMP/2

1 055000322



C55PM

pensile per arredo officina

1024x400x300 mm dotato di molle a gas per facilitare l'apertura e la chiusura delle ante.

24 kg

C55 PM

1 055000302



C55PM/S

struttura portante per sostegno pensili C55PM

31 kg

C55PM/S

1 055000303



C552PF

pannelli forati portautensili per arredo officina

- 2 pannelli forati 1024x600 mm per il sostegno degli utensili
- Da abbinare alla struttura C55 2PM

12 kg

C552PF

1 055000310



C55A1

armadio in lamiera a un'anta per arredo officina

- 3 ripiani amovibili regolabili in altezza
- Dotato di serratura
- Misure utili interne: 1770x420x420 mm

50 kg

C55A1

1 055000401



C55A1/R42

ripiano interno per armadio C55A1

2,4 kg

C55A1/R42

420x420 mm

1 055000451

C55A2

armadio in lamiera a due ante per arredo officina

- 3 ripiani amovibili regolabili in altezza
- Dotato di serratura
- Misure utili interne: 1770x700x420 mm

📦 72 kg



C55A2

1 055000402

C55A2/R70

ripiano interno per armadio C55A2

📦 3,5 kg

C55A2/R70 700x420 mm

1 055000452

Beta

C55AB-PRO/1

combinazione arredo officina

Combinazione composta da:

- Armadio a 2 ante (C55 A2)
- Banco da lavoro con prese (C55B-PRO)
- Modulo fisso con 2 cassettoni (C55 M2)
- Modulo fisso con 7 cassetti (C55 M7)
- Parete portautensili con tapparella (C55 PSP)

411 kg



C55AB-PRO/1

1 055000031



C55AB/2

combinazione arredo officina

Combinazione composta da:

- Armadio a 2 ante (C55 A2)
- Banco da lavoro (C55 B)
- Modulo fisso con 7 cassetti (C55 M7)
- Modulo fisso di servizio (C55 MS)
- Parete con pensili (C55 2PM)

407 kg



C55AB/2

1 055000022





Combinazione completa composta da:

- Armadio ad 1 anta (C55 A1)
- Armadio a 2 ante (C55 A2)
- Banco da lavoro (C55 B)
- Banco da lavoro con prese (C55B-PRO)
- Cassettiera mobile con 7 cassetti (C55 C7)
- Modulo fisso con 2 cassettoni (C55 M2)
- Modulo fisso con 7 cassetti (C55 M7)
- Modulo fisso di servizio (C55 MS)
- Parete con pensili (C55 2PM)
- Parete portautensili con tapparella (C55 PSP)







ATTENZIONE!

Alcuni assortimenti, illustrati nelle prossime pagine, presentano variazioni:







- inserimento di nuovi utensili
- razionalizzazione degli utensili proposti.

Sugeriamo quindi di esaminare accuratamente la composizione di tali assortimenti e consultare le caratteristiche dell'articolo di riferimento.

Per manutenzioni industriali

Beta n.	N. pezzi				Beta n.	N. pezzi			
5902VI	107	1	059020050	294	5910VI/3	297	1	059100053	299
5904VI/1T	98	1	059040161	295	5910VI/3T	256	1	059100062	300
5904VI/2T	153	1	059040164	296	5953VI	137	1	059530075	301
5904VI/3T	142	1	059040168	297	5954VI	115	1	059540075	302



Per interventi universali

Beta n.	N. pezzi				Beta n.	N. pezzi			
5904VU/1M	91	1	059040201	304	5915VU/5	111	1	059150156	312
5904VU/2M	152	1	059040202	305	5915VU/AS	68	1	059150132	313
5904VU/3T	146	1	059040203	306	5927VU/M	108	1	059270021	314
5915VU/0	35	1	059150121	307	5938U/2T	210	1	059380062	315
5915VU/1	45	1	059150124	308	5955U	113	1	059550000	316
5915VU/2	49	1	059150127	309	5957U	132	1	059570026	317



Per elettronica, elettrotecnica e idraulica

Beta n.	N. pezzi				Beta n.	N. pezzi			
5980ET/A	69	1	059800262	319	5980EL/A	57	1	059800241	322
5980ET/B	64	1	059800263	320	5980EL/B	98	1	059800242	323
					5980ID	35	1	059800321	324

Per autoriparazione e movimento terra

Beta n.	N. pezzi				Beta n.	N. pezzi			
5902MT	106	1	059020043	325	5905VG/1	94	1	059050158	332
5902MT/AS	99	1	059020044	326	5905VG/2	118	1	059050144	333
5904VG/1M	76	1	059040197	327	5908VG/2T	212	1	059080117	334
5904VG/2M	170	1	059040198	328	5910VG/3T	202	1	059100067	335
5904VG/2T	99	1	059040191	329	5953VG	147	1	059530085	337
5904VG/3	132	1	059040192	330	5954VG	138	1	059540085	338
					5957VG	189	1	059570029	339

Per motorizzazione

Beta n.	N. pezzi			
5940SBK	124	1	059400081	336

Manutenzioni industriali



19,5 kg

N. pezzi/Descrizione

6	cacciaspina Ø 2 - 3 - 4 - 5 - 6 - 8 mm	Beta N.	31
1	bulino Ø 3 mm		32
1	scalpelli piatti nervati 200 mm		35
26	chiavi combinate 6+32 mm	42/S26	
12	chiavi a forchetta 6x7 - 8x9 - 10x11 - 12x13 - 14x15 - 16x17 - 18x19 - 20x22 - 21x23 - 24x26 - 25x28 - 30x32 mm	55/S12	
9	chiavi maschio esagonale piegate Ø 1,5 - 2 - 2,5 - 3 - 4 - 5 - 6 - 8 - 10 mm	96N/SC9	
1	chiave regolabile a rullino 300 mm		111
13	chiavi a bussola esagonali 1/2" con guida Ø 10+22 mm	920A/SB13	
1	prolunga - 1/2" 125 mm	920/21	
1	prolunga - 1/2" 255 mm	920/22	
1	snodo 1/2"	920/25	
1	quadro maschio 1/2" con spina scorrevole	920/42	
1	cricchetto reversibile 1/2" Ⓢ	920/55	
1	pinze regolabili cerniera chiusa 250 mm	1048	
1	pinza autobloccante 240 mm	1052	
1	tronchesi a grande effetto taglienti diagonali 160 mm	1084BM	
1	cesoia a doppia leva diritta 250 mm	1122	
1	forbici per elettricisti lame diritte	1128BMX	

N. pezzi/Descrizione

1	pinza universale 180 mm	Beta N.	1150BM
1	pinza a becchi mezzotondi dritti 160 mm		1166BM
8	giravite lama piatta 2,5x50 - 3x75 - 3,5x100 - 4x125 - 5,5x125 - 6,5x150 - 8x200 - 10x200 mm		1260
4	giravite per viti con impronta a croce Phillips® PH0x60 - PH1x80 - PH2x100 - PH3x150 mm		1262
1	martello tipo tedesco 500 g		1370
1	mazzuola antirimbalo Ø 40 mm		1392
1	punta per tracciare		1688A
1	flessometro 5 m		1692
1	spessimetro		1708/20
5	serie di 5 lime 200 mm		1719BMA/S5
1	seghetto		1726BM
1	oliatore in metallo a pressione 300 cc		1751
1	cutter con lama a settori		1771BM
1	lampada magnetica snodata con LED ad alta luminosità		1837N

5902VI

059020050

2200S-O/VI
(C22S-O+5902VI)

022000461

2200S-G/VI

(C22S-G+5902VI)

022000462

2200S-R/VI

(C22S-R+5902VI)

022000463

2500/VI

(C25+5902VI)

025000087

5904VI/1T







assortimento di 98 utensili in termoformato

Manutenzioni industriali



14.5 kg

N. pezzi/Descrizione	Beta N.	TR	N. pezzi/Descrizione	Beta N.	TR
19 chiavi a bussola esagonali 1/2" ○ 10+24 - 26 - 27 - 30 - 32 mm	920A	T80	1 pinze becchi diritti per anelli elastici, per alberi ● 175 mm	1036	T145
5 chiavi a bussola maschio esagonale 1/2" ○ 5 - 6 - 8 - 10 - 12 mm	920ME	T80	1 pinze becchi piegati per anelli elastici, per alberi ● 175 mm	1038	T145
1 prolunga - 1/2" 125 mm	920/21	T80	5 lime a taglio mezzodolce 200 mm	1719BMA8/S5	T236
1 prolunga - 1/2" 255 mm	920/22	T80	2 scalpelli piatti nervati 100 - 200 mm	35	T234
1 snodo 1/2"	920/25	T80	1 martello tipo tedesco 300 g	1370	T234
1 quadro maschio 1/2" con spina scorrevole	920/42	T80	1 mazzuola con battenti in materiale plastico Ø 35 mm	1390	T234
1 cricchetto reversibile 1/2" ⊕	920/55	T80	8 chiavi a forchetta 6x7 - 8x9 - 10x11 - 12x13 - 14x15 - 16x17 - 18x19 - 20x22 mm	55	T33
21 chiavi combinate 6÷21 mm	42	T15	9 chiavi maschio esagonale piegate ○ 1,5 - 2 - 2,5 - 3 - 4 - 5 - 6 - 8 - 10 mm	96/SC9	T33
5 chiavi combinate 22-24-27-30-32 mm	42	T16	4 giravite lama piatta ● 3x75 - 4x100 - 5,5x150 - 6,5x150 mm	1260	T208
1 pinze regolabili cerniera chiusa 250 mm	1048	T153	3 giravite per viti con impronta a croce Phillips®	1262	T208
1 pinza autobloccante 240 mm	1052	T153	⊕ PH0x60 - PH1x80 - PH2x100 mm		
1 tronchesi a grande effetto taglienti diagonali † 160 mm	1084BM	T131	6 chiavi a T maschio esagonale ○ 2,5 - 3 - 4 - 5 - 6 - 8 mm	951	T68
1 pinza universale 180 mm	1150BM	T131			
1 pinza a becchi mezzotondi diritti ● 160 mm	1166BM	T131			
1 pinze becchi diritti per anelli elastici, per fori ○ 180 mm	1032	T145			
1 pinze becchi piegati per anelli elastici, per fori ○ 170 mm	1034	T145			

 5904VI/1T	059040161	 2400S5-RV1T (C24S5/R+5904VI/1T)	024002506	 2400S6-RV1T (C24S6/R+5904VI/1T)	024002616
 2400S5-OM1T (C24S5/O+5904VI/1T)	024002504	 2400S6-OM1T (C24S6/O+5904VI/1T)	024002614		
 2400S5-GV1T (C24S5/G+5904VI/1T)	024002505	 2400S6-GV1T (C24S6/G+5904VI/1T)	024002615		

Manutenzioni industriali



T15 T16 T31



T40 T83 T91



T167 T168



T153 T132 T145 T68



T236 T234 T281 T289

22 kg

N. pezzi/Descrizione

- 16 chiavi combinate 6÷21 mm
- 5 chiavi combinate 22 - 24 - 27 - 30 - 32 mm
- 5 cacciapina Ø 2 - 3 - 4 - 5 - 6 mm
- 1 bulino Ø 4 mm
- 12 chiavi a forchetta 6x7 - 8x9 - 10x11 - 12x13 - 14x15 - 16x17 - 18x19 - 20x22 - 21x23 - 24x26 - 27x29 - 30x32 mm
- 9 chiavi maschio esagonale piegate Ø 1,5 - 2 - 2,5 - 3 - 4 - 5 - 6 - 8 - 10 mm
- 7 chiavi poligonali curve 6÷29 mm
- 19 chiavi a bussola esagonali 1/2"
 - 10÷24 - 26 - 27 - 30 - 32 mm
- 1 prolunga - 1/2" 125 mm
- 1 prolunga - 1/2" 255 mm
- 1 snodo 1/2"
- 1 quadro maschio 1/2" con spina scorrevole
- 1 cricchetto reversibile 1/2" ®
- 13 chiavi a bussola esagonali 1/4" ○ 4÷14 mm
- 6 chiavi a bussola maschio esagonale 1/4" ○ 2,5÷8 mm
- 1 prolunga - 1/4" 50 mm
- 1 prolunga - 1/4" 150 mm
- 1 snodo 1/4"
- 1 quadro con impugnatura 1/4"
- 1 quadro scorrevole 1/4"
- 1 cricchetto reversibile 1/4" ®
- 9 giravite lama piatta ● 3x75 - 3x100 - 4x100 - 4x150 - 5,5x100 - 5,5x150 - 6,5x150 - 8x150 - 10x200 mm
- 2 giravite nano lama piatta ● 4x30 - 6,5x30 mm
- 7 giravite per viti con impronta a croce Phillips® ⊕ PH0x60 - PH0x100 - PH1x80 - PH1x120 - PH2x100 - PH2x150 - PH3x150 mm

Beta N.	TR
42	T15
42	T16
31	T31
32	T31
55	T31
96N/SC9	T31
90	T40
920A	T83
920/21	T83
920/22	T83
920/25	T83
920/42	T83
920/55	T83
900	T91
900ME	T91
900/20	T91
900/21	T91
900/25	T91
900BG/30	T91
900/42	T91
900/55	T91
1260	T167
1260N	T167
1262	T168

N. pezzi/Descrizione

- 2 giraviti nano Phillips® ⊕ PH1x30 - PH2x30 mm
- 1 pinze regolabili cerniera chiusa 250 mm
- 1 pinza autobloccante 240 mm
- 1 tronchesi a grande effetto taglienti diagonali < 160 mm
- 1 pinza a becchi mezzotondi dritti ● 160 mm
- 1 pinza universale = 180 mm
- 1 pinze becchi dritti per anelli elastici, per fori ○ 180 mm
- 1 pinze becchi piegati per anelli elastici, per fori ○ 170 mm
- 1 pinze becchi dritti per anelli elastici, per alberi ● 175 mm
- 1 pinze becchi piegati per anelli elastici, per alberi ● 175 mm
- 6 chiavi a T maschio esagonale ○ 2,5 - 3 - 4 - 5 - 6 - 8 mm
- 5 lime a taglio mezzodolce 200 mm
- 2 scalpelli piatti nervati 100 - 200 mm
- 1 martello tipo tedesco 300 g
- 1 mazzuola con battenti in materiale plastico Ø 35 mm
- 1 rivettatrice
- 100 rivetti 2,9x6 mm
- 100 rivetti 3,2x8 mm
- 100 rivetti 3,8x10 mm
- 100 rivetti 4x12 mm
- 100 rivetti 4,8x12 mm
- 1 flessometro
- 1 miniseghetto
- 1 oliatore in plastica
- 1 cutter con lama a settori

Beta N.	TR
1262N	T168
1048	T153
1052	T153
1084	T132
1166	T132
1150	T132
1032	T145
1034	T145
1036	T145
1038	T145
951	T68
1719BMA8/S5	T236
35	T234
1370	T234
1390	T234
1741B	T281
1741RV...K	T281
1741RV...K	T281
1741RV...K	T281
1741RV...K	T281
1741RV...K	T281
1692	T289
1725CR	T289
1755	T289
1771	T289

5904VI/2T 059040164

2400SL-OVI/2T (C24SL7 O+5904VI/2T) 024002431

2400SL-GVI/2T (C24SL7 G+5904VI/2T) 024002432

2400SL-RVI/2T (C24SL7 R+5904VI/2T) 024002433

2400S7-OVI/2T (C24S7/O+5904VI/2T) 024002434

2400S7-GVI/2T (C24S7/G+5904VI/2T) 024002435

2400S7-RVI/2T (C24S7/R+5904VI/2T) 024002436

Manutenzioni industriali

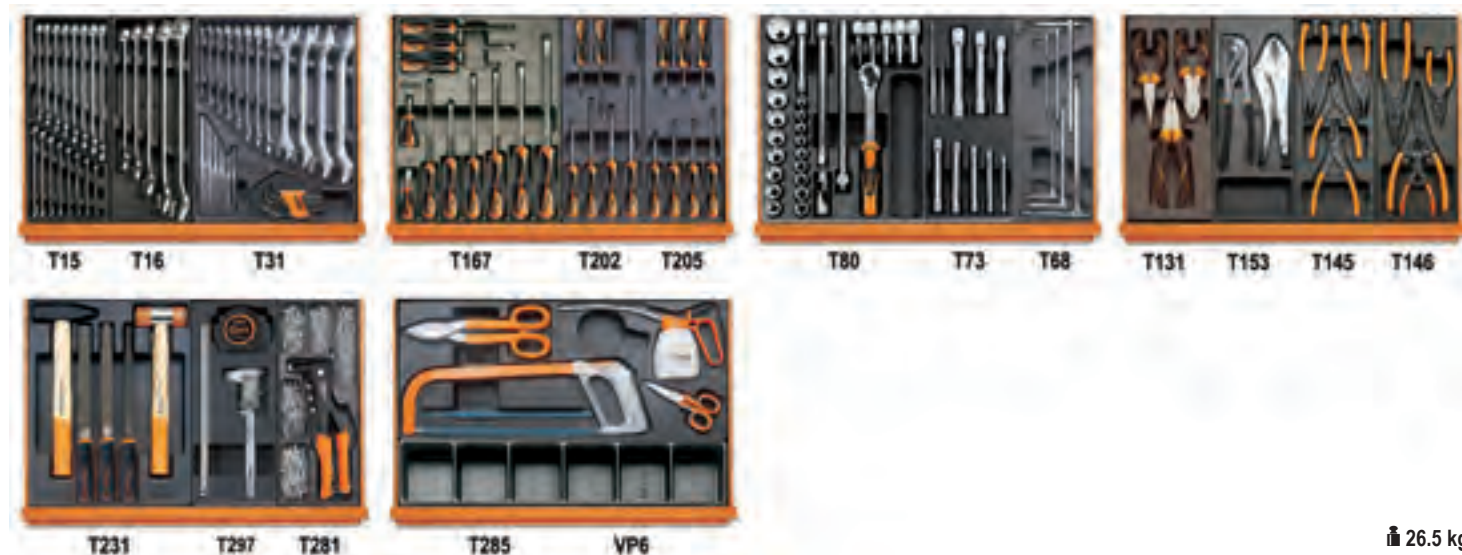

26.5 kg

N. pezzi/Descrizione

N. pezzi/Descrizione	Beta N.	TR
16 chiavi combinate 6÷21 mm	42	T15
5 chiavi combinate 22 - 24 - 27 - 30 - 32 mm	42	T16
5 cacciaspina Ø 2 - 3 - 4 - 5 - 6 mm	31	T31
1 bulino Ø 4 mm	32	T31
12 chiavi a forchetta 6x7 - 8x9 - 10x11 - 12x13 - 14x15 - 16x17 - 18x19 - 20x22 - 21x23 - 24x26 - 27x29 - 30x32 mm	55	T31
9 chiavi maschio esagonale piegate Ø 1,5 - 2 - 2,5 - 3 - 4 - 5 - 6 - 8 - 10 mm	96N/SC9	T31
9 giravite lama piatta ● 3x75 - 3,5x100 - 4x100 - 4x150 - 5,5x100 - 5,5x150 - 6,5x150 - 8x150 - 10x200 mm	1260	T167
2 giravite nano lama piatta ● 4x30 - 6,5x30 mm	1260N	T167
6 giravite per viti con impronta a croce Phillips® ● PH0x60 - PH0x100 - PH1x80 - PH1x120 - PH2x100 - PH2x150 mm	1262	T202
7 chiavi a bussola per viti con impronta Torx® ● T6-T7-T8-T9-T10-T15-T20	1267TX	T205
5 chiavi a bussola maschio esagonale 1/2" ● 5 - 6 - 8 - 10 - 12 mm	920ME	T80
1 prolunga - 1/2" 125 mm	920/21	T80
1 prolunga - 1/2" 255 mm	920/22	T80
1 snodo 1/2"	920/25	T80
1 quadro maschio 1/2" con spina scorrevole	920/42	T80
1 cricchetto reversibile 1/2" ●	920/55	T80
19 chiavi a bussola esagonali 1/2" ● 10+24 - 26 - 27 - 30 - 32 mm	920A	T80
8 chiavi a tubo doppie poligonali 6x7 - 8x9 - 10x11 - 12x13 - 14x15 - 16x17 - 18x19 - 20x22 mm	930	T73
1 spine di manovra per chiavi a tubo 1 - 2	940/1	T73
1 spine di manovra per chiavi a tubo 1 - 2	940/2	T73
6 chiavi a T maschio esagonale ● 2,5 - 3 - 4 - 5 - 6 - 8 mm	951	T68
1 pinza universale 180 mm	1150BM	T131
1 pinza a becchi mezzotondi dritti ● 160 mm	1166BM	T131
1 tronchesi a grande effetto taglianti diagonali ● 160 mm	1084BM	T131

N. pezzi/Descrizione

N. pezzi/Descrizione	Beta N.	TR
1 pinze regolabili cerniera chiusa 250 mm	1048	T153
1 pinza autobloccante 240 mm	1052	T153
1 pinze becchi dritti per anelli elastici, per fori ● 180 mm	1032	T145
1 pinze becchi piegati per anelli elastici, per fori ● 170 mm	1034	T145
1 pinze becchi dritti per anelli elastici, per alberi ● 175 mm	1036	T145
1 pinze becchi piegati per anelli elastici, per alberi ● 175 mm	1038	T145
1 pinze becchi dritti per anelli elastici, per fori ● 140 mm	1032	T146
1 pinze becchi piegati per anelli elastici, per fori ● 225 mm	1034	T146
1 pinze becchi dritti per anelli elastici, per alberi ● 140 mm	1036	T146
1 pinze becchi piegati per anelli elastici, per alberi ● 225 mm	1038	T146
1 martello tipo tedesco 400 g	1370	T231
1 mazzuola con battenti in materiale plastico Ø 35 mm	1390	T231
1 lime a taglio mezzodolce 200 mm	1719BMA8/T	T231
1 lime a taglio mezzodolce 200 mm	1719BMA8/P	T231
1 lime a taglio mezzodolce 200 mm	1719BMA8/M	T231
1 calibro digitale a corsoio	1651DGT	T297
1 riga flessibile graduata 300 mm	1682	T297
1 flessometro 5 m termoformato vuoto	1691BM	T297
1 rivettatrice 250 mm	VP6	T297
100 rivetti 2,9x6 mm	1741RV...K	T281
100 rivetti 3,2x8 mm	1741RV...K	T281
100 rivetti 3,8x10 mm	1741RV...K	T281
100 rivetti 4x12 mm	1741RV...K	T281
100 rivetti 4,8x12 mm	1741RV...K	T281
1 cesoia a lame larghe dritte 250 mm	1112	T285
1 forbici per elettricisti lame dritte	1128BM	T285
1 seghetto	1726	T285
(5) lame per seghetti	1728BM	T285
1 oliatore in plastica a pressione 200 cc termoformato vuoto	1753	T285
	VP6	VP6

	5904 VI/3T	059040168		2400SAXL7-R/VI3T (C24SA-XL/7 R+5904VI/3T)	024002466		2400 S8-R/VI3T (C24S8/R+5904VI/3T)	024002863
	2400SAXL7-O/VI3T (C24SA-XL/7 O+5904VI/3T)	024002464		2400 S8-O/VI3T (C24S8/O+5904VI/3T)	024002861			
	2400SAXL7-G/VI3T (C24SA-XL/7 G+5904VI/3T)	024002465		2400 S8-G/VI3T (C24S8/G+5904VI/3T)	024002862			

Manutenzioni industriali

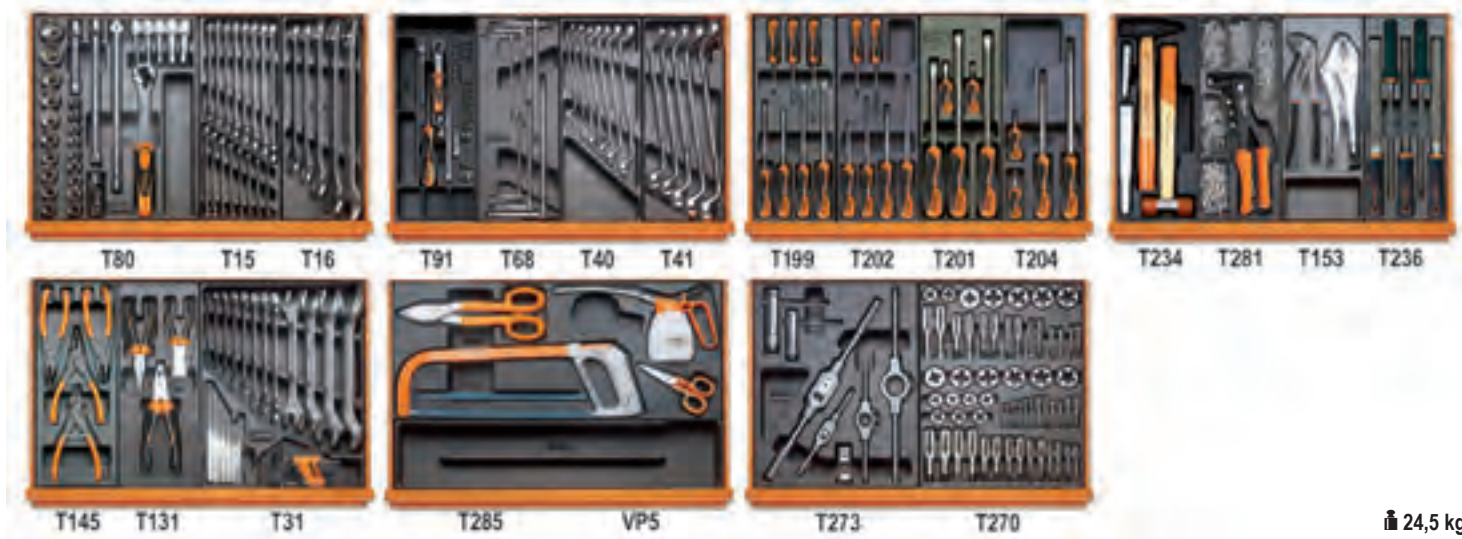

24,5 kg

N. pezzi/Descrizione

Beta N. TR

N. pezzi/Descrizione

Beta N. TR

5	chiavi a bussola maschio esagonale 1/2" \varnothing 5 - 6 - 8 - 10 - 12 mm	920ME	T80
1	prolunga - 1/2" 125 mm	920/21	T80
1	prolunga - 1/2" 255 mm	920/22	T80
1	snodo 1/2"	920/25	T80
1	quadro maschio 1/2" con spina scorrevole	920/42	T80
1	cricchetto reversibile 1/2" \oplus	920/55	T80
19	chiavi a bussola esagonali 1/2" \varnothing 10÷24 - 26 - 27 - 30 - 32 mm	920A	T80
16	chiavi combinate 6÷21 mm	42	T15
5	chiavi combinate 22 - 24 - 27 - 30 - 32 mm	42	T16
13	chiavi a bussola esagonali 1/4" \varnothing 4÷14 mm	900	T91
6	chiavi a bussola maschio esagonale 1/4" \varnothing 2,5 - 3 - 4 - 5 - 6 - 8 mm	900ME	T91
1	prolunga - 1/4" 50 mm	900/20	T91
1	prolunga - 1/4" 150 mm	900/21	T91
1	quadro con impugnatura 1/4"	900BG/30	T91
1	snodo 1/4"	900/25	T91
1	quadro scorrevole 1/4"	900/42	T91
1	cricchetto reversibile 1/4" \oplus	900/55	T91
6	chiavi a T maschio esagonale \varnothing 2,5 - 3 - 4 - 5 - 6 - 8 mm	951	T68
7	chiavi poligonali curve 6x7-8x9-10x11-12x13-14x15-16x17-18x19 mm	90	T40
5	chiavi poligonali curve 20x22 - 21x23 - 24x26 - 25x28 - 27x29 mm	90	T41
7	giravite lama piatta \bullet 2,5x50 - 3x75 - 3,5x100 - 4x125 - 5,5x100 - 5,5x150 - 6,5x150 mm	1260	T199
6	giravite per viti con impronta a croce Phillips® \oplus PH0x60 - PH0x100 - PH1x80 - PH1x120 - PH2x100 - PH2x150 mm	1262	T202
3	giravite lama piatta \bullet 8x200 - 10x150 - 10x200 mm	1260	T201
2	giravite nano lama piatta \bullet 4x30 - 6,5x30 mm	1260N	T201
2	giravite per viti con impronta a croce Phillips® \oplus PH3x150 - PH4x200 mm	1262	T204
2	giraviti nano Phillips® \oplus PH1x30 - PH2x30 mm	1262N	T204
2	scalpelli piatti nervati 100 - 200 mm	35	T234
1	martello tipo tedesco 300 g	1370	T234
1	mazzuola con battenti in materiale plastico \varnothing 35 mm	1390	T234
1	rivettatrice 250 mm	1741B	T281
100	rivetti 2,9x6 mm	1741RV...K	T281
100	rivetti 3,2x8 mm	1741RV...K	T281
100	rivetti 3,8x10 mm	1741RV...K	T281

100	rivetti 4x12 mm	1741RV...K	T281
100	rivetti 4,8x12 mm	1741RV...K	T281
1	pinze regolabili cerniera chiusa 250 mm	1048	T153
1	pinza autobloccante 240 mm	1052	T153
5	lime a taglio mezzodolce 200 mm	1719BMA8/S	T236
1	pinze becchi dritti per anelli elastici, per fori \varnothing 180 mm	1032	T145
1	pinze becchi piegati per anelli elastici, per fori \varnothing 170 mm	1034	T145
1	pinze becchi dritti per anelli elastici, per alberi \bullet 175 mm	1036	T145
1	pinze becchi piegati per anelli elastici, per alberi \bullet 175 mm	1038	T145
1	pinza universale 180 mm	1150BM	T131
1	pinza a becchi mezzotondi dritti \bullet 160 mm	1166BM	T131
1	tronchesi a grande effetto taglienti diagonali ∇ 160 mm	1084BM	T131
5	cacciaspina \varnothing 2 - 3 - 4 - 5 - 6 mm	31	T31
1	bulino \varnothing 4 mm	32	T31
12	chiavi a forchetta 6x7 - 8x9 - 10x11 - 12x13 - 14x15 - 16x17 - 18x19 - 20x22 - 21x23 - 24x26 - 27x29 - 30x32 mm	55	T31
9	chiavi maschio esagonale piegate \varnothing 1,5 - 2 - 2,5 - 3 - 4 - 5 - 6 - 8 - 10 mm	96N/SC9	T31
1	cesoia a lame larghe diritte 250 mm	1112	T285
1	forbici per elettricisti lame dritte	1128BM	T285
1	seghetto	1726	T285
5	lame per seghetti	1728BM	T285
1	oliatore in plastica a pressione 200 cc	1753	T285
1	termoformato vuoto	VP5	VP5
1	giramaschi regolabile M3+M12	435/1,5	T273
1	giramaschi regolabile M5+M21	435/3	T273
1	giramaschi a cricchetto reversibile 2,0÷5,0 mm (M3+M8)	436/1	T273
1	giramaschi a cricchetto reversibile 4,6÷8,0 mm (M5+M12)	436/2	T273
1	girafiliera 25,4 mm	444/1	T273
1	girafiliera 38,1 mm	444/2	T273
1	contafiletto 0,25÷6 W 62÷4x1"	1707	T273
26	maschi a mano passo grosso M3 - 4 - 5 - 6 - 7 - 8 - 9 - 10 - 12 - 14 - 16 - 18 - 20	430	T270
14	maschi a mano passo fine M6x0,75 - M8x1 - M10x1,25 - M12x1,5 - M14x1,5 - M16x1,5 - M18x1,5	433	T270
7	filiere tonde passo grosso M3 - 4 - 5 - 6 - 7 - 8 - 9	440	T270
6	filiere tonde passo grosso M10 - 12 - 14 - 16 - 18 - 20	440A	T270
2	filiere tonde passo fine M6x0,75 - M8x0,75	441	T270
5	filiere tonde passo fine M10x1,25 - M12x1,5 - M14x1,5 - M16x1,5 - M18x1,5	441A	T270

5908VI/2T

059080105

2800 GV/2T
(C28 G+5908VI/2T)

028000325

2800 OV/2T
(C28 O+5908VI/2T)

028000324

2800 RV/2T
(C28 R+5908VI/2T)

028000326

Manutenzioni industriali



N. pezzi/Descrizione

6	cacciaspina Ø 2 - 3 - 4 - 5 - 6 - 8 mm	31/B6
1	bulino Ø 4 mm	32
2	scalpelli piatti nervati 125 - 250 mm	35
1	ugnetto nervato 200 mm	37
30	chiavi combinate 6÷41 mm	42
14	chiavi a forchetta 6x7 - 8x9 - 10x11 - 12x13 - 14x15 - 16x17 - 18x19 - 20x22 - 21x23 - 24x26 - 25x28 - 27x29 - 30x32 - 36x41 mm	55
13	chiavi poligonali curve 6x7÷30x32 mm	90
14	chiavi maschio esagonale piegate ○ 1,5 - 2 - 2,5 - 3 - 4 - 5 - 6 - 8 - 10 - 12 - 13 - 14 - 17 - 19 mm	96N
1	chiave regolabile a rullino 250 mm	111
1	giratubi modello americano 300 mm	362
25	punte elicoidali cilindriche, serie corta 1÷13x0,5 mm	412/SP25
37	assortimento di maschi e filiere in acciaio HSS	447/C37
1	chiave dinamometrica a scatto 1/2", 40÷200 Nm	606/20
4	chiavi a bussola maschio esagonale 1/2" ○ 10-12-14-17 mm	920ME
25	20 chiavi a bussola e 5 accessori	920A/C20X
17	assortimento di 12 chiavi a bussola e 5 accessori 3/4"	928A/C12
12	chiavi a pipa doppie esagonali - poligonali 8 - 10 - 11 - 13 - 14 - 17 - 19 - 22 - 24 - 27 - 30 - 32 mm	932
14	chiavi a T maschio esagonale 2÷14 mm	951/S14
5	chiavi a T con maschio esagonale snodato ○ 3 - 4 - 5 - 6 - 8 mm	953
3	pinze becchi diritti per anelli elastici, per fori ○ 180 - 225 - 300 mm	1032
3	pinze becchi piegati per anelli elastici, per fori ○ 170 - 210 - 290 mm	1034
3	pinze becchi diritti per anelli elastici, per alberi ● 140x1,3 - 175 - 225 mm	1036
3	pinze becchi piegati per anelli elastici, per alberi ● 135x1,3 - 175 - 220 mm	1038
2	pinze regolabili cerniera chiusa 240 - 300 mm	1048
1	pinza autobloccante a doppia regolazione	1051
1	tronchesi a grande effetto taglienti diagonali ✂ 160 mm	1084BM

Beta N. N. pezzi/Descrizione

1	tronchesi doppia leva taglio frontale ✂ 180 mm	1092V
1	cesoia a lame larghe diritte 300 mm	1112
1	cesoia a lame strette diritte 250 mm	1114
1	forbici per elettricisti lame diritte	1128BMX
1	pinza universale 180 mm	1150BM
1	pinza a becchi mezzotondi diritti ● 160 mm	1166BM
1	pinza a becchi mezzotondi piegati ● 160 mm	1168BM
9	giravite lama piatta ● 2,5x50 - 3x75 - 3,5x150 - 4x125 - 5,5x125 - 6,5x150 - 8x200 - 10x200 - 12x250 mm	1260
2	giravite nano lama piatta ● 4x30 - 6,5x30 mm	1260N
5	giravite per viti con impronta a croce Phillips® ⚙ PH0x100 - PH1x120 - PH2x150 - PH3x150 - PH4x200 mm	1262
2	giraviti nano Phillips® ⚙ PH1x30 - PH2x30 mm	1262N
7	chiave maschio per viti con impronta Torx® ⚙ T6 - T8 - T10 - T15 - T20 - T25 - T30	1267TX
2	martello tipo tedesco 300 - 600 g	1370
2	mazzuola con battenti in materiale plastico Ø 35 - 60 mm	1390
5	estrattori conici M3÷M18	1430/S5
1	estrattore universale a due griffe 23÷70 mm	1500N/1
1	estrattore universale a due griffe 23÷100 mm	1500N/2
1	calibro a corsoio	1650
1	riga semirigida 300 mm	1683
1	punta per tracciare	1688A
1	flessometro 5 m	1692
1	spessimetro	1708/13
1	flessibile magnetico 1,8 kg	1712E/2
5	lime 200 mm	1719BMA/S5
1	seghetto	1726BM
1	rivettatrice	1741B
1	oliatore in metallo a pressione 200 cc	1751

5910VI/3

059100053

3000 M/3
(C30S+5910VI/3)

030000099

Manutenzioni industriali



N. pezzi/Descrizione

Beta N. TR

N. pezzi/Descrizione

Beta N. TR

16	chiavi combinate 6÷21 mm	42	T15
5	chiavi combinate 22 - 24 - 27 - 30 - 32 mm	42	T16
5	cacciaspina Ø 2 - 3 - 4 - 5 - 6 mm	31	T31
1	bulino Ø 4 mm	32	T31
12	chiavi a forchetta 6x7 - 8x9 - 10x11 - 12x13 - 14x15 - 16x17 - 18x19 - 20x22 - 21x23 - 24x26 - 27x29 - 30x32 mm	55	T31
9	chiavi maschio esagonale piegate Ø 1,5 - 2 - 2,5 - 3 - 4 - 5 - 6 - 8 - 10 mm	96N/SC9	T31
5	chiavi poligonali curve 20x22 - 21x23 - 24x26 - 25x28 - 27x29 mm	90	T41
7	chiavi poligonali curve 6x7 - 8x9 - 10x11 - 12x13 - 14x15 - 16x17 - 18x19 mm	90	T40
5	chiavi a bussola maschio esagonale 1/2" Ø 5 - 6 - 8 - 10 - 12 mm	920ME	T80
1	prolunga - 1/2" 125 mm	920/21	T80
1	prolunga - 1/2" 255 mm	920/22	T80
1	snodo 1/2"	920/25	T80
1	quadro maschio 1/2" con spina scorrevole	920/42	T80
1	cricchetto reversibile 1/2" Ⓢ	920/55	T80
19	chiavi a bussola esagonali 1/2" Ø 10+24 - 26 - 27 - 30 - 32 mm	920A	T80
9	giravite lama piatta ● 3x75 - 3x100 - 4x100 - 4x150 - 5,5x100 - 5,5x150 - 6,5x150 - 8x150 - 10x200 mm	1260	T167
2	giravite nano lama piatta ● 4x30 - 6,5x30 mm	1260N	T167
7	giravite per viti con impronta a croce Phillips® Ⓢ PH0x60 - PH0x100 - PH1x80 - PH1x120 - PH2x100 - PH2x150 - PH3x150 mm	1262	T168
2	giraviti nano Phillips® Ⓢ PH1x30 - PH2x30 mm	1262N	T168
4	chiavi maschio esagonale piegate Ø 13-14-17-19 mm	96N	T168
1	cesoia a lame larghe diritte 250 mm	1112	T285
1	forbici per elettricisti lame dritte	1128BM	T285
1	seghetto	1726	T285
(5)	lame per segchetti	1728BM	T285
1	oliatore in plastica a pressione 200 cc	1753	T285
1	pinza universale 180 mm	1150BM	T131
1	pinza a becchi mezzotondi diritti ● 160 mm	1166BM	T131
1	tronchese a grande effetto taglienti diagonali ⚡ 160 mm	1084BM	T131
1	pinze becchi diritti per anelli elastici, per fori Ⓢ 180 mm	1032	T145
1	pinze becchi piegati per anelli elastici, per fori Ⓢ 170 mm	1034	T145

1	pinze becchi diritti per anelli elastici, per alberi ● 175mm	1036	T145
1	pinze becchi piegati per anelli elastici, per alberi ● 175mm	1038	T145
2	scalpelli piatti nervati 100 - 200 mm	35	T234
1	martello tipo tedesco 300 g	1370	T234
1	mazzuola con battenti in materiale plastico Ø 35 mm	1390	T234
1	lime a taglio mezzodolce 200 mm	1719BMA8/S5	T236
4	chiavi combinate 35-36-38-41 mm	42	
1	chiavi a forchetta 36x41 mm	55	
1	chiave regolabile a rullino 250 mm	111	
1	giratubi modello americano 300 mm	362	
25	punte elicoidali cilindriche, serie corta	412/SP25	
37	assortimento di maschi e filiere in acciaio HSS	447/C37	
1	chiave dinamometrica a scatto 200 Nm	606/20	
17	assortimento di 12 chiavi a bussola e 5 accessori 3/4"	928A/C12	
14	chiavi a T maschio esagonale	951/S14	
5	chiavi a T con maschio esagonale snodato Ø 3-4-5-6-8 mm	953	
1	pinze becchi diritti per anelli elastici, per fori Ⓢ 300 mm	1032	
1	pinze becchi piegati per anelli elastici, per fori Ⓢ 290 mm	1034	
1	pinze becchi diritti per anelli elastici, per alberi ● 225 mm	1036	
1	pinze becchi piegati per anelli elastici, per alberi ● 220 mm	1038	
1	pinze regolabili cerniera chiusa 300 mm	1048	
1	pinza autobloccante a doppia regolazione	1051	
1	tronchese doppia leva taglio frontale ⚡ 180 mm	1092V	
1	martello tipo tedesco 600 g	1370	
1	mazzuola con battenti in materiale plastico 60 mm	1390	
5	estrattori conici M3-M18	1430/S5	
1	estrattore universale a due griffe	1500/3	
1	calibro a corsoio	1650	
1	riga semirigida	1683	
1	punta per tracciare	1688	
1	flessometro 5 m	1692	
1	spessimetro	1708/13	
1	flessibile magnetico	1712E/2	



Manutenzioni industriali



22,5 kg

N. pezzi/Descrizione

5	cacciaspina Ø 2 - 3 - 4 - 5 - 6 mm
1	bulino Ø 4 mm
2	scalpelli piatti nervati 200 - 250 mm
18	chiavi combinate 6+14 - 16 - 17 - 18 - 19 - 21 - 22 - 24 - 27 - 30 mm
12	chiavi a forchetta 6x7 - 8x9 - 10x11 - 12x13 - 14x15 - 16x17 18x19 - 20x22 - 21x23 - 24x26 - 27x29 - 30x32 mm
12	chiavi maschio esagonale piegate Ø 2+10 mm
1	chiave regolabile a rullino 250 mm
1	giratubi svedese 320 mm
20	chiavi a bussola poligonali 1/2" ○ 10+24 - 26 - 27 - 28 - 30 - 32 mm
6	chiavi a bussola maschio esagonale 1/2" ○ 5 - 6 - 8 - 10 - 12 - 14 mm
1	prolunga - 1/2" 125 mm
1	prolunga - 1/2" 255 mm
1	snodo 1/2"
1	quadro maschio a T snodato 1/2"
1	quadro maschio 1/2" con spina scorrevole
1	cricchetto reversibile 1/2" Ⓢ
6	chiavi a T maschio esagonale ○ 2,5 - 3 - 4 - 5 - 6 - 8 mm
2	pinze becchi dritti per anelli elastici, per fori ○ 140 - 180 mm
1	pinze becchi piegati per anelli elastici, per fori ○ 170 mm
2	pinze becchi dritti per anelli elastici, per alberi ● 140x1,3 - 175 mm
1	pinze becchi piegati per anelli elastici, per alberi ● 175 mm

Beta N.

31
32
35
42
55
96/SC12
111
374
920B
920ME
920/21
920/22
920/25
920/40
920/42
920/55
951
1032
1034
1036
1038

N. pezzi/Descrizione

1	pinze regolabili cerniera chiusa 240 mm
1	pinza autobloccante 240 mm
1	tronchesi a grande effetto taglienti diagonali ≤ 160 mm
1	tronchesi doppia leva taglio frontale ≤ 180 mm
1	cesoia a lame larghe diritte 250 mm
1	forbici per elettricisti lame diritte
1	pinza universale 180 mm
1	pinza a becchi mezzotondi dritti ● 160 mm
1	giravite cercafase ●
9	giravite lama piatta ● 3x75 - 3,5x100 - 4x100 - 5,5x100 - 5,5x150 - 6,5x150 - 8x150 - 10x200 - 12x250 mm
2	giravite nano lama piatta ● 4x30 - 6,5x30 mm
8	giravite per viti con impronta a croce Phillips® ● PH0x60 - PH0x100 - PH1x80 - PH1x120 - PH2x100 - PH2x150 - PH3x150 - PH4x200 mm
2	giraviti nano Phillips® ● PH1x30 - PH2x30 mm
2	martello tipo tedesco 300 - 500 g
1	mazzuola con battenti in materiale plastico Ø 45 mm
1	flessibile magnetico 0,5 kg
5	lime a taglio mezzodolce 200 mm
1	seghetto
1	oliatore in plastica a pressione 250 cc

Beta N.

1048
1052
1084BM
1092V
1112
1128BMX
1150BM
1166BM
1253
1260
1260N
1262
1262N
1370
1390
1712E/1
1719BMA8/S5
1726BM
1754

5953VI

059530075

5300VI
(C53VI+5953VI)

053000015

Manutenzioni industriali



17 kg

N. pezzi/Descrizione

2	punzoni Ø 2 - 3 mm	30
5	cacciaspina Ø 2 - 3 - 4 - 5 - 6 mm	31
1	bulino Ø 4 mm	32
1	scalpelli piatti 150 mm	34
1	ugnetti 150 mm	36
18	chiavi combinate 6+22 - 24 mm	42
12	chiavi a forchetta 6x7 - 8x9 - 10x11 - 12x13 - 14x15 - 16x17 - 18x19 - 20x22 - 21x23 - 24x27 - 25x28 - 30x32 mm	55/S12X
12	chiavi maschio esagonale piegate Ø 2+10 mm	96/SC12
1	chiave regolabile a rullino 250 mm	111
20	chiavi a bussola esagonali 1/2" ○ 10+24 - 26 - 27 - 28 - 30 - 32 mm	920A
1	prolunga - 1/2" 125 mm	920/21
1	prolunga - 1/2" 255 mm	920/22
1	snodo 1/2"	920/25
1	quadro maschio 1/2" con spina scorrevole	920/42
1	cricchetto reversibile 1/2" ⊕	920/55
1	pinze becchi dritti per anelli elastici, per fori ○ 180 mm	1032
1	pinze becchi piegati per anelli elastici, per fori ○ 170 mm	1034
1	pinze becchi dritti per anelli elastici, per alberi ● 175 mm	1036
1	pinze becchi piegati per anelli elastici, per alberi ● 175 mm	1038
1	pinze regolabili cerniera chiusa 250 mm	1048
1	pinza autobloccante 240 mm	1052
1	tronchesi a taglienti diagonali ₹ 160 mm	1082BM
1	cesoia a lame larghe diritte 250 mm	1112

Beta N. N. pezzi/Descrizione

1	forbici per elettricisti lame diritte	1128BMX
1	pinza universale 180 mm	1150BM
1	pinza a becchi mezzotondi dritti ● 160 mm	1166BM
1	pinza a becchi mezzotondi piegati ● 200 mm	1168BM
5	giravite lama piatta ● 3x75 - 4x125 - 5,5x125 - 6,5x150 - 10x200 mm	1260
1	giravite nano lama piatta ● 4x30 mm	1260N
3	giravite per viti con impronta a croce Phillips®	1262
	⊕ PH0x60 - PH1x80 - PH2x100 mm	
1	giraviti nano Phillips® ⊕ PH1x30 mm	1262N
1	martello tipo tedesco 400 g	1370
1	mazzuola antirimbazzo Ø 35 mm	1392
1	estrattore a due griffe oscillanti	1515/3
1	pinza per capicorda preisolati	1602
1	flessometro 5 m	1692
1	spessimetro	1708/20
1	flessibile magnetico 1,8 kg	1712E/2
5	lime a taglio mezzodolce 200 mm	1719BMA/S5
1	seghetto	1726BM
1	rivettatrice	1741B
1	oliatore in plastica a pressione 250 cc	1754

5954VI

059540075

5400 GVI
(C54VI G+5954VI)

054000152

5400 OVI
(C54VI O+5954VI)

054000150

5400 RVI
(C54VI R+5954VI)

054000154

Manutenzioni industriali



32 kg

N. pezzi/Descrizione

6	cacciaspina Ø 2 - 3 - 4 - 5 - 6 - 8 mm
6	punzoni, 1 bulino, 3 scalpelli con supporto
19	chiavi combinate 6+22 - 24 - 27 mm
12	chiavi poligonali curve 6x7+30x32 mm
12	chiavi maschio esagonale piegate Ø 2+10 mm
1	chiave regolabile a rullino 250 mm
13	chiavi a bussola poligonali 1/2" con guida Ø 10+22 mm
8	chiavi a bussola poligonali 1/2" con guida Ø 23+32 mm
4	chiavi a bussola a giravite lama piatta 1/2" ● 1,2x6,5 - 1,2x8 - 1,6x9 - 2x12 mm
3	chiavi a bussola a giravite lama Phillips® 1/2" ● PH2 - 3 - 4
1	prolunga - 1/2" 125 mm
1	prolunga - 1/2" 255 mm
1	snodo 1/2"
1	quadro maschio snodato 1/2" con impugnatura
1	quadro maschio 1/2" con spina scorrevole
1	cricchetto reversibile 1/2" ●
1	leva con estremità a punta e piatta curva
1	pinzetta punte fini curve 130 mm
1	pinzetta punte larghe diritte 150 mm
1	pinze becchi dritti per anelli elastici, per fori Ø 180 mm
1	pinze becchi piegati per anelli elastici, per fori Ø 170 mm
1	pinze becchi dritti per anelli elastici, per alberi ● 175 mm
1	pinze becchi piegati per anelli elastici, per alberi ● 175 mm
1	pinze regolabili cerniera chiusa 250 mm
1	pinza autobloccante a doppia regolazione
1	tronchesi a grande effetto taglienti diagonali 160 mm
1	tronchesi doppia leva taglio frontale 180 mm
1	cesoia a lame larghe diritte 250 mm
1	cesoia a lame strette diritte 250 mm
1	forbici per elettricisti lame diritte
1	pinza universale 180 mm
1	pinza a becchi mezzotondi dritti ● 160 mm

Beta N.

31/SP6
38/SP6
42
90/S12X
96/SC12
111
920B/SB13
920B/SB8
920LP
920PH
920/21
920/22
920/25
920/35A
920/42
920/55
963
991
994
1032
1034
1036
1038
1048
1051
1084BM
1092V
1112
1114
1128BMX
1150BM
1166BM

N. pezzi/Descrizione

1	pinza a becchi mezzotondi piegati ● 200 mm
7	giravite lama piatta ● 3x75 - 3,5x100 - 4x125 - 5,5x150 - 6,5x150 - 10x200 - 12x250 mm
1	giravite lama piatta con esagono di manovra ● 12x250 mm
3	giravite per viti con impronta a croce Phillips® ● PH0x60 - PH1x80 - PH2x100 mm
2	martello tipo tedesco 300 - 600 g
1	mazzuola con battenti in materiale plastico Ø 35 mm
1	flessometro 5 m
1	flessibile magnetico 1,8 kg
1	raschietto a due taglienti 200 mm
1	raschietto a tre taglienti 200 mm
5	lime a taglio mezzodolce 200 mm
1	seghetto
1	oliatore in metallo a pressione 200 cc
2	scalpelli piatti nervati 200 - 250 mm
1	ugnetto nervato 200 mm
6	chiavi maschio esagonali con impugnatura Ø 2+6 mm
10	chiavi a pipa doppie esagonali - poligonali 8 - 10 - 11 - 13 - 14 - 17 - 19 - 22 - 24 - 27 mm
1	pinze becchi dritti per anelli elastici, per fori Ø 140 mm
1	pinze becchi piegati per anelli elastici, per fori Ø 130 mm
1	pinze becchi dritti per anelli elastici, per alberi ● 140x1,3 mm
1	pinze becchi piegati per anelli elastici, per alberi ● 135x1,3 mm
1	pinza autobloccante 280 mm
1	pinza autobloccante 290 mm
1	martello tipo tedesco 1000 g
1	mazzuola antirimbalzo Ø 50 mm
1	estrattore universale a due griffe 25+130 mm
1	calibro a corsoio
1	riga semirigida 300 mm
1	punta per tracciare
1	spessimetro
1	coltello a serramanico

Beta N.

1168BM
1260
1260E
1262
1370
1390
1692
1712E/2
1717A
1717B
1719BMA/S5
1725
1751
35
37
96T/S6
932
1032
1034
1036
1038
1060
1062
1370
1392
1500N/2
1650
1683
1688A
1708/13
1777BM

5957VI

059570027

5700 AOMI
(C57S A/O+5957VI)

057001091

5700 BOMI
(C57S B/O+5957VI)

057001093

5700 AGVI
(C57S A/G+5957VI)

057001291

5700 BGVI
(C57S B/G+5957VI)

057001293

5700 ARVI
(C57S A/R+5957VI)

057001491

5700 BRVI
(C57S B/R+5957VI)

057001493

Universali



M15 M33 M199 M202



M50 M83



M132 M153 M234 M145

N. pezzi/Descrizione

- 16 chiavi combinate 6÷21 mm
- 8 chiavi a forchetta 6x7 - 8x9 - 10x11 - 12x13 - 14x15 - 16x17 - 18x19 - 20x22 mm
- 9 chiavi maschio esagonale piegate \odot 1,5 - 2 - 2,5 - 3 - 4 - 5 - 6 - 8 - 10 mm
- 7 giravite lama piatta \bullet 2,5x50 - 3x75 - 3,5x100 - 4x125 - 5,5x100 - 5,5x150 - 6,5x150 mm
- 6 giravite per viti con impronta a croce Phillips® \oplus PH0x60 - PH0x100 - PH1x80 - PH1x120 - PH2x100 - PH2x150 mm
- 8 chiavi maschio esagonale con impugnatura \odot 2-2,5-3-4-5-6-7-8 mm
- 1 prolunga angolare - 1/2" 125 mm
- 1 prolunga angolare - 1/2" 250 mm
- 1 snodo 1/2"
- 1 quadro maschio 1/2" con spina scorrevole
- 1 cricchetto reversibile 1/2" \otimes
- 19 chiavi a bussola esagonali 1/2" \odot 10÷24 - 26 - 27 - 30 - 32 mm

Beta N.

TR

- 42 M15
- 55 M33
- 96/SC9 M33
- 1260 M199
- 1262 M202
- 96T M50
- 920AN/125 M83
- 920AN/250 M83
- 920/25 M83
- 920/42 M83
- 920/55 M83
- 920A M83

N. pezzi/Descrizione

- 1 tronchesi a grande effetto taglienti diagonali \leq 160 mm
- 1 pinza universale \equiv 180 mm
- 1 pinza a becchi mezzotondi dritti \bullet 160 mm
- 1 pinze regolabili cerniera chiusa 250 mm
- 1 pinza autobloccante 240 mm
- 2 scalpelli piatti nervati 100 - 200 mm
- 1 martello tipo tedesco 300 g
- 1 mazzuola con battenti in materiale plastico \varnothing 35 mm
- 1 pinze becchi dritti per anelli elastici, per fori \odot 180 mm
- 1 pinze becchi piegati per anelli elastici, per fori \odot 170 mm
- 1 pinze becchi dritti per anelli elastici, per alberi \bullet 175 mm
- 1 pinze becchi piegati per anelli elastici, per alberi \bullet 175 mm

Beta N.

TR

- 1084 M132
- 1150 M132
- 1166 M132
- 1048 M153
- 1052 M153
- 35 M234
- 1370 M234
- 1390 M234
- 1032 M145
- 1034 M145
- 1036 M145
- 1038 M145

5904VU/1M

059040201



2400S5-GVU1M
(C24S5/G+5904VU/1M)

024002518



2400S5-OVU1M
(C24S5/O+5904VU/1M)

024002517



2400S5-RVU1M
(C24S5/R+5904VU/1M)

024002519

Universali



M15 M33 M199 M202



M50 M83



M132 M153 M237 M145



M204 M289 M85 M236

N. pezzi/Descrizione

- 16 chiavi combinate 6+21 mm
- 8 chiavi a forchetta 6x7 - 8x9 - 10x11 - 12x13 - 14x15 - 16x17 - 18x19 - 20x22 mm
- 9 chiavi maschio esagonale piegate \odot 1,5 - 2 - 2,5 - 3 - 4 - 5 - 6 - 8 - 10 mm
- 7 giravite lama piatta \bullet 2,5x50 - 3x75 - 3,5x100 - 4x125 - 5,5x100 - 5,5x150 - 6,5x150 mm
- 6 giravite per viti con impronta a croce Phillips® \oplus PH0x60 - PH0x100 - PH1x80 - PH1x120 - PH2x100 - PH2x150 mm
- 8 chiavi maschio esagonale con impugnatura \odot 2-2,5-3-4-5-6-7-8 mm
- 1 prolunga angolare - 1/2" 125 mm
- 1 prolunga angolare - 1/2" 250 mm
- 1 snodo 1/2"
- 1 quadro maschio 1/2" con spina scorrevole
- 1 cricchetto reversibile 1/2" \oplus
- 19 chiavi a bussola esagonali 1/2" \odot 10+24 - 26 - 27 - 30 - 32 mm
- 1 tronchesi a grande effetto taglienti diagonali ∇ 160 mm
- 1 pinza universale \equiv 180 mm
- 1 pinza a becchi mezzotondi diritti \bullet 160 mm
- 1 pinze regolabili cerniera chiusa 250 mm
- 1 pinza autobloccante 240 mm
- 2 scalpelli piatti nervati 100 - 200 mm
- 1 martello tipo tedesco 300 g
- 1 mazzuola \varnothing 35 mm

Beta N.

TR

- 42 M15
- 55 M33
- 96/SC9 M33
- 1260 M199
- 1262 M202
- 96T M50
- 920AN/125 M83
- 920AN/250 M83
- 920/25 M83
- 920/42 M83
- 920/55 M83
- 920A M83
- 1084 M132
- 1150 M132
- 1166 M132
- 1048 M153
- 1052 M153
- 35 M237
- 1370T M237
- 1390N M237

N. pezzi/Descrizione

- 1 pinze becchi diritti per anelli elastici, per fori \odot 180 mm
- 1 pinze becchi piegati per anelli elastici, per fori \odot 170 mm
- 1 pinze becchi diritti per anelli elastici, per alberi \bullet 175 mm
- 1 pinze becchi piegati per anelli elastici, per alberi \bullet 175 mm
- 6 chiave maschio per viti con impronta Torx® \odot T8-T10-T15-T20-T25-T30
- 1 flessometro 5 m
- 1 miniseghetto
- 1 oliatore in plastica 30 cc
- 1 cutter con lama a settori
- 5 inserti colorati per avvitatori per viti a testa con intaglio \bullet 0,5x3 - 0,6x4,5 - 0,8x5,5 - 1x5,5 - 1,2x6,5 mm
- 8 inserti colorati maschio esagonale per avvitatori \odot 2 - 2,5 - 3 - 4 - 5 - 6 - 8 - 10 mm
- 5 inserti colorati per avvitatori per viti con impronta a croce Phillips® \oplus PH0 - PH1 - PH2 - PH3 - PH4
- 4 inserti colorati per avvitatori per viti con impronta a croce Pozidriv® - Supadriv® \oplus PZ1 - PZ2 - PZ3 - PZ4
- 10 inserti colorati per avvitatori per viti con impronta Torx® \odot T6-T7-T8-T9-T10-T15-T20-T25-T27-T30-T40
- 8 inserti colorati per avvitatori per viti con impronta Tamper Resistant Torx® \oplus T9-T10-T15-T20-T25-T27-T30-T40
- 1 portainseri a sgancio rapido con impugnatura 230 mm
- 1 cricchetto reversibile portainseri 100 mm
- 1 raccordi per avvitatori
- 1 prolunga portainseri magnetica

Beta N.

TR

- 1032 M145
- 1034 M145
- 1036 M145
- 1038 M145
- 1267TX M204
- 1692 M289
- 1725CR M289
- 1755 M289
- 1771 M289
- 860LP M85
- 860PE M85
- 860PH M85
- 860PZ M85
- 860TX M85
- 860RTX M85
- 851SR M85
- 860/55 M85
- 892/0 M85
- 882P M85

5904VU/2M

059040202



2400S7-RVU2M
(C24S7R+5904VU/2M)

024002746



3900 R-7VU2M
(C39 R7+5904VU/2M)

039000156



2400S7-OVU2M
(C24S7O+5904VU/2M)

024002744



2400S7-GVU2M
(C24S7G+5904VU/2M)

024002745

3900 O-7VU2M
(C39 O7+5904VU/2M)

039000154

3900 G-7VU2M
(C39 G7+5904VU/2M)

039000155

Universali



T15 T16 T31



T52 T55 T80



T91 T145 T132 T153



T198 T205 T234 T236

N. pezzi/Descrizione

16	chiavi combinate 6÷21 mm
5	chiavi combinate 22 - 24 - 27 - 30 - 32 mm
5	cacciaspina Ø 2 - 3 - 4 - 5 - 6 mm
1	bulino Ø 4 mm
12	chiavi a forchetta 6x7 - 8x9 - 10x11 - 12x13 - 14x15 - 16x17 - 18x19 - 20x22 - 21x23 - 24x26 - 27x29 - 30x32 mm
9	chiavi maschio esagonale piegate Ø 1,5 - 2 - 2,5 - 3 - 4 - 5 - 6 - 8 - 10 mm
6	chiavi maschio esagonale con impugnatura Ø 2 - 2,5 - 3 - 4 - 5 - 6 mm
6	chiavi maschio con impugnatura per viti con impronta Torx® T10-T15-T20-T25-T27-T30
5	chiavi a bussola maschio esagonale 1/2" Ø 5 - 6 - 8 - 10 - 12 mm
1	prolunga - 1/2" 125 mm
1	prolunga - 1/2" 255 mm
1	snodo 1/2"
1	quadro maschio 1/2" con spina scorrevole
1	cricchetto reversibile 1/2" Ⓢ
19	chiavi a bussola esagonali 1/2" Ø 10÷24 - 26 - 27 - 30 - 32 mm
13	chiavi a bussola esagonali 1/4" Ø 4-4,5-5-5,5-6-7-8-9-10-11-12-13-14 mm
6	chiavi a bussola maschio esagonale 1/4" Ø 2,5-3-4-5-6-8 mm
1	prolunga - 1/4" 50 mm
1	prolunga - 1/4" 150 mm
1	snodo 1/4"
1	quadro con impugnatura 1/4"
1	quadro scorrevole 1/4" 115 mm

Beta N. TR

42	T15
42	T16
31	T31
32	T31
55	T31
96N/SC9	T31
96T	T52
97TTX	T55
920ME	T80
920/21	T80
920/22	T80
920/25	T80
920/42	T80
920/55	T80
920A	T80
900	T91
900ME	T91
900/20	T91
900/21	T91
900/25	T91
900BG/30	T91
900/42	T91

N. pezzi/Descrizione

1	cricchetto reversibile 1/4" Ⓢ
1	pinze becchi dritti per anelli elastici, per fori Ø 180 mm
1	pinze becchi piegati per anelli elastici, per fori Ø 170 mm
1	pinze becchi dritti per anelli elastici, per alberi Ø 175 mm
1	pinze becchi piegati per anelli elastici, per alberi Ø 175 mm
1	pinza universale = 180 mm
1	pinza a becchi mezzotondi dritti Ø 160 mm
1	tronchesi a grande effetto taglienti diagonali 160 mm
1	pinze regolabili cerniera chiusa 250 mm
1	pinza autobloccante 240 mm
4	giravite lama piatta Ø 3x75 - 4x100 - 5,5x150 - 6,5x150 mm
3	giravite per viti con impronta a croce Pozidriv®-Supadriv® Ⓢ PZ0 - PZ1 - PZ2
7	chiave maschio per viti con impronta Torx® Ⓢ T6-T7-T8-T9-T10-T15-T20
2	scalpelli piatti nervati 100 - 200 mm
1	martello tipo tedesco 300 g
1	mazzuola con battenti in materiale plastico Ø 35 mm
5	lime a taglio mezzodolce 200 mm

Beta N. TR

900/55	T91
1032	T145
1034	T145
1036	T145
1038	T145
1150	T132
1166	T132
1084	T132
1048	T153
1052	T153
1260	T198
1269PZ	T198
1267TX	T205
35	T234
1370	T234
1390	T234
1719BMA8/S5	T236

5904VU/3T

059040203

2400S7-G/VU3T
(C24S7/G+5904VU/3T)

024002748

2400S7-O/VU3T
(C24S7/O+5904VU/3T)

024002747

2400S7-R/VU3T
(C24S7/R+5904VU/3T)

024002749

Universali



4,3 kg

N. pezzi/Descrizione

- 1 bulino 4 mm
- 1 scalpelli piatti nervati 125 mm
- 8 chiavi a forchetta 6x7-8x9-10x11-12x13-14x1516x17-18x19-20x22 mm
- 7 chiavi maschio esagonale \odot 1,5-2-2,5-3-4-5-6 mm
- 1 chiave regolabile a rullino 150 mm
- 1 pinze regolabili cerniera chiusa 250 mm
- 1 tronchesi a taglienti diagonali \nlessgtr 160 mm
- 1 forbici per elettricisti lame diritte
- 1 pinza universale \equiv 180 mm

Beta N.

- 32
- 35
- 55
- 96/BGS7
- 111
- 1048
- 1082
- 1128BMX
- 1150

N. pezzi/Descrizione

- 1 pinza a becchi mezzotondi dritti \bullet 160 mm
- 4 giravite lama piatta \bullet 3x75-4x100-5,5x100-6,5x150 mm
- 3 giravite Phillips® \oplus PH0x60-PH1x80-PH2x100 mm
- 1 martello tipo tedesco 300 g
- 1 flessometro 3 m
- 1 cutter con lama a settori 18 mm
- 1 coltello soccorso auto
- 1 torcia LED ad alta luminosità

Beta N.

- 1166
- 1201
- 1202
- 1370
- 1692/3
- 1771
- 1778SOS
- 1834PS

5915VU/0

059150121



2106T VU/0
(C6T+5915VU/0)

021060121

2105 VU/0
(C5+5915VU/0)

021050121



2104 VU/0
(C4+5915VU/0)

021040121

Universali



5 kg

N. pezzi/Descrizione

- 2 punzoni Ø 2-3 mm
- 1 bulino Ø 4 mm
- 2 scalpelli piatti 125-150 mm
- 1 ugnetti 150 mm
- 14 chiavi combinate 6+14 - 17 - 19 - 21 - 22 - 24 mm
- 9 chiavi maschio esagonale piegate
Ø 1,5 - 2 - 2,5 - 3 - 4 - 5 - 6 - 8 - 10 mm
- 1 chiave regolabile a rullino 250 mm
- 1 pinze regolabili cerniera chiusa 250 mm
- 1 tronchesi a taglienti diagonali 160 mm
- 1 forbici per elettricisti lame diritte

Beta N.

- 30
- 32
- 34
- 36
- 42
- 96/SC9
- 111
- 1048
- 1082
- 1128BMX

N. pezzi/Descrizione

- 1 pinza universale = 180 mm
- 1 pinza a becchi mezzotondi dritti 160 mm
- 4 giravite lama piatta 3x75 - 4x100 - 5,5x100 - 6,5x150 mm
- 3 giravite Phillips® PH0x60 - PH1x80 - PH2x100 mm
- 1 martello tipo tedesco 300 g
- 1 flessometro 5 m
- 1 cutter con lama a settori

Beta N.

- 1150
- 1166
- 1201
- 1202
- 1370
- 1692
- 1771

5915VU/1	059150124	2117PLVU/1 (CP17L+5915VU/1)	021170141	2116VU/1 (C16+5915VU/1)	021160101
2109VU/1 (C9+5915VU/1)	021090021	2118VU/1 (C18+5915VU/1)	021180031	2115P VU/1 (CP15+5915VU/1)	021150231
2110VU/1 (C10+5915VU/1)	021100021	2110SVU/1 (C10S+5915VU/1)	021100101	2115P L-VU/1 (CP15L+5915VU/1)	021150241
2117PVU/1 (CP17+5915VU/1)	021170041	2111VU/1 (C11+5915VU/1)	021110101		

5915VU/2

assortimento di 49 utensili

Universali



4,6 kg

N. pezzi/Descrizione

N. pezzi/Descrizione	Beta N.
8 chiavi a forchetta 6x7 - 8x9 - 10x11 - 12x13 - 14x15 - 16x17 - 18x19 - 20x22 mm	55/B8
9 chiavi maschio esagonale piegate Ø 1,5 - 2 - 2,5 - 3 - 4 - 5 - 6 - 8 - 10 mm	96/SC9
13 chiavi a bussola esagonali 1/4" Ø 4 - 4,5 - 5 - 5,5 - 6 - 7 - 8 - 9 - 10 - 11 - 12 - 13 - 14 mm	900
1 prolunga - 1/4" 150 mm	900/21
1 snodo 1/4"	900/25
1 quadro con impugnatura 1/4"	900BG/30
1 quadro scorrevole 1/4"	900/42
1 cricchetto reversibile 1/4" ®	900/55

N. pezzi/Descrizione

N. pezzi/Descrizione	Beta N.
1 pinze regolabili cerniera chiusa 250 mm	1048
1 forbici per elettricisti lame diritte	1128BMX
1 pinza universale = 180 mm	1150
4 giravite lama piatta ⚙ 3x75 - 4x100 - 5,5x150 - 6,5x150 mm	1201
3 giravite Phillips® ⚙ PH0x60 - PH1x80 - PH2x100 mm	1202
1 martello tipo tedesco 300 g	1370
1 flessometro 3 m	1692
1 oliatore in plastica 30 cc	1755
1 cutter con lama a settori 18 mm	1771

5915VU/2

059150127



2120LVU/2
(C20L+5915VU/2)

021200116



2107 VU/2
(C7+5915VU/2)

021070102

2120VU/2
(C20+5915VU/2)

021200016



2115P VU/2
(CP15+5915VU/2)

021150233

Universali



8,1 kg

N. pezzi/Descrizione

- 1 cacciaspina Ø 4 mm
- 1 bulino Ø 4 mm
- 1 scalpelli piatti 150 mm
- 14 chiavi combinate 6÷17 - 19 - 22 - 24 mm
- 9 chiavi maschio esagonale piegate \odot 1,5÷10 mm
- 3 chiavi maschio esagonale con impugnatura \odot 4 - 5 - 6 mm
- 1 chiave regolabile a rullino 250 mm
- 13 chiavi a bussola esagonali 1/2" \odot 8÷17 - 19 - 22 - 24 mm
- 1 prolunga - 1/2" 255 mm
- 1 snodo 1/2"
- 1 quadro maschio 1/2" con spina scorrevole
- 1 cricchetto reversibile 1/2" \otimes
- 8 chiavi a tubo doppie serie leggera 6x7 - 8x9 - 10x11 - 12x13 - 14x15 - 16x17 - 18x19 - 20x22 mm
- 2 spine di manovra per chiavi a tubo 1 - 2
- 1 pinze regolabili cerniera chiusa 250 mm

Beta N.

- 31
- 32
- 34
- 42
- 96/SC9
- 96T
- 111
- 920A
- 920/22
- 920/25
- 920/42
- 920/55
- 935
- 940
- 1048V

N. pezzi/Descrizione

- 1 pinza autobloccante 240 mm
- 1 tronchesi a grande effetto taglienti diagonali \leq 160 mm
- 1 forbici per elettricisti lame dritte
- 1 pinza universale 180 mm
- 1 pinza a becchi mezzotondi dritti \bullet 160 mm
- 4 giravite lama piatta \bullet 3x75 - 4x100 - 5,5x150 - 6,5x150 mm
- 3 giravite Phillips® \bullet PH0x60 - PH1x80 - PH2x100 mm
- 1 martello tipo tedesco 400 g
- 1 flessometro 5 m
- 1 seghetto
- 1 oliatore in plastica 150 cc
- 1 cutter con lama a settori

Beta N.

- 1052
- 1084BM
- 1128BMX
- 1150BM
- 1166BM
- 1201
- 1202
- 1370
- 1692
- 1726
- 1755
- 1771

	5915 VU5	059150128		2119VU/3 (C19+5915VU/3)	021190024		2111VU/3 (C11+5915VU/3)	021110104
	2109VU/3 (C9+5915VU/3)	021090124		2119L-VU/3 (C19L+5915VU/3)	021190124		2116VU/3 (C16+5915VU/3)	021160104
	2110VU/3 (C10+5915VU/3)	021100024		2120VU/3 (C20+5915VU/3)	021200028		2115P L-VU/3 (CP15L+5915VU/3)	021150244
	2117PVU/3 (CP17+5915VU/3)	021170044		2120L-VU/3 (C20L+5915VU/3)	021200128		2107 VU/3 (C7+5915VU/3)	021070104
	2117PLVU/3 (CP17L+5915VU/3)	021170144		2110SVU/3 (C10S+5915VU/3)	021100104			

Universali



11,2 kg

N. pezzi/Descrizione

- 1 cacciaspina Ø 4 mm
- 1 bulino Ø 4 mm
- 1 scalpelli piatti 150 mm
- 15 chiavi combinate 6÷17 - 19 - 22 - 24 mm
- 9 chiavi maschio esagonale piegate \odot 1,5÷10 mm
- 1 chiave regolabile a rullino 250 mm
- 13 chiavi a bussola esagonali 1/2" \odot 8÷17 - 19 - 22 - 24 mm
- 1 prolunga - 1/2" 255 mm
- 1 snodo 1/2"
- 1 quadro maschio 1/2" con spina scorrevole
- 1 cricchetto reversibile 1/2" \otimes
- 17 chiavi a pipa doppie esagonali - poligonali 6÷22 mm
- 1 pinze regolabili cerniera chiusa 250 mm
- 1 pinza autobloccante 240 mm

Beta N. N. pezzi/Descrizione

- 31
- 32
- 34
- 42
- 96/SC9
- 111
- 920A
- 920/22
- 920/25
- 920/42
- 920/55
- 932/S17
- 1048
- 1052
- 1 tronchesi a grande effetto taglienti diagonali \nlessgtr 160 mm
- 1 forbici per elettricisti lame diritte
- 1 pinza universale 180 mm
- 1 pinza a becchi mezzotondi diritti \bullet 160 mm
- 4 giravite lama piatta \bullet 3x75 - 4x100 - 5,5x150 - 6,5x150 mm
- 3 giravite Phillips \oplus PH0x60 - PH1x80 - PH2x100 mm
- 1 martello tipo francese 32 mm
- 1 flessometro 5 m
- 1 seghetto
- 1 oliatore in plastica 150 cc
- 1 cutter con lama a settori

Beta N.

- 1084BM
- 1128BMX
- 1150BM
- 1166BM
- 1201
- 1202
- 1370F
- 1692
- 1726
- 1755
- 1771

5915VU/4

 059150145

2120VU/4

(C20+5915VU/4)

021200018

2120LVU/4

(C20L+5915VU/4)

021200118

Universali



N. pezzi/Descrizione

1	cacciaspina Ø 4 mm	
1	bulino Ø 4 mm	
1	scalpelli piatti 150 mm	
17	chiavi combinate 6-7-8-9-10-11-12-13-14-15-16-17-18-19-20-21-22 mm	
8	chiavi a forchetta 6x7-8x9-10x11-12x13-14x15-16x17-18x19-20x22 mm	55/S8
1	chiave regolabile a rullino 250 mm	111
9	chiavi maschio esagonale piegate con estremità sferica	96BPC/SC9
39	Serie di bussole e accessori, in cassetta	900/C11
13	Serie di bussole e accessori, in cassetta	920A/C11
1	pinze regolabili cerniera chiusa 250 mm	1048
1	pinza autobloccante 240 mm	1052
1	tronchesi a taglienti diagonali 160 mm	1082

Beta N. N. pezzi/Descrizione

1	tenaglie per cementisti 220 mm	1098
1	forbici per elettricisti lame dritte	1128BMX
1	pinza universale 180 mm	1150
1	pinza a becchi mezzotondi diritti 160 mm	1166
3	giravite Phillips® PH0x60 - PH1x80 - PH2x100 mm	1202
1	martello tipo tedesco 300 g	1370
1	mazzuola con battenti in materiale plastico Ø 35 mm	1390
1	flessometro 3 m	1692/3
1	lime a taglio mezzodolce	1719BMA8/M
1	seghetto 440 mm	1726
1	cutter con lama a settori 18 mm	1771BM
1	torcia LED	1835/2

5915 VU/5

059150156

2112VU/5
(C12+5915VU/5)

021120156

Universali



9,3 kg

N. pezzi/Descrizione

1	cacciaspina Ø 4 mm	31
1	bulino Ø 4 mm	32
1	scalpelli piatti 150 mm	34
13	chiavi combinate 1/4 - 5/16 - 3/8 - 7/16 - 1/2 - 9/16 - 5/8 - 11/16 - 3/4 - 13/16 - 7/8 - 15/16 - 1"	42AS
8	chiavi poligonali curve 1/4"+1"	90AS/8
9	chiavi maschio esagonale piegate brunito ○ 3/64"÷3/8"	96AS/SC9
1	chiave regolabile a rullino 250 mm	111
11	chiavi a bussola poligonali □ 1/2" ○ 3/8 - 7/16 - 1/2 - 9/16 - 5/8 - 11/16 - 3/4 - 13/16 - 7/8 - 15/16 - 1"	920AS
1	prolunga - 1/2" 255 mm	920/22
1	snodo 1/2"	920/25
1	quadro maschio 1/2" con spina scorrevole	920/42
1	cricchetto reversibile 1/2" Ⓞ	920/55
1	pinze regolabili cerniera chiusa 250 mm	1048V

Beta N.

N. pezzi/Descrizione

1	pinza autobloccante 240 mm	1052
1	tronchesi a grande effetto taglianti diagonali 160 mm	1084BM
1	forbici per elettricisti lame dritte	1128BMX
1	pinza universale 180 mm	1150BM
1	pinza a becchi mezzotondi dritti 160 mm	1166BM
4	giravite lama piatta 3x75 - 4x100 - 5,5x150 - 6,5x150 mm	1201
3	giravite Phillips® PH0x60 - PH1x80 - PH2x100 mm	1202
1	martello tipo tedesco 300 g	1370
1	flessometro 5 m	1692
1	seghetto	1726
1	oliatore in plastica 150 cc	1755
1	cutter con lama a settori	1771

Beta N.

	5915VU/AS	059150132		2120-VU/AS (C20+5915VU/AS)	021200021
	2110VU/AS (C10+5915VU/AS)	021100026		2120L-VU/AS (C20L+5915VU/AS)	021200121

5927VU/M

assortimento di 108 utensili in termoformato morbido



MC10



MC20

N. pezzi/Descrizione

Beta N. TR

16	chiavi combinate 6-7-8-9-10-11-12-13-14-15-16-17-18-19-21-22 mm	42	MC10
9	chiavi maschio esagonale piegate O 1,5-2-2,5-3-4-5-6-8-10 mm	96/SC9	MC10
1	tronchesi a grande effetto taglienti diagonali 160 mm	1084BM	MC10
1	pinza universale 180 mm	1150BM	MC10
1	pinza a becchi mezzotondi diritti 160 mm	1166BM	MC10
3	giravite lama piatta 3,5x100-5,5x150-6,5x150 mm	1201	MC10
3	giravite Phillips® PH0x3x60-PH1x4,5x80-PH2x6x100 mm	1202	MC10
31	inserti colorati con portainseriti magnetico in astuccio tascabile O O O O O	860MIX/A31	MC20
1	pinze regolabili cerniera chiusa 250 mm	1048	MC20
1	martello tipo tedesco 300 mm	1370	MC20
1	bulino 4 mm	32	MC20

N. pezzi/Descrizione

Beta N. TR

1	ugnetti 4 mm	36	MC20
13	chiavi a bussola esagonali 1/4" O 4-4,5-5-5,5-6-7-8-9-10-11-12-13-14 mm	900	MC20
1	prolunga - 1/4" 150 mm	900/21	MC20
1	snodo 1/4"	900/25	MC20
1	quadro maschio 1/4"	900BG/30C	MC20
1	quadro scorrevole 1/4"	900/42	MC20
1	cricchetto reversibile 1/4" ®	900/55	MC20
16	chiavi a bussola esagonali 1/2" O 10-11-12-13-14-15-16-17-18-19-21-22-24-27-30-32 mm	920A	MC20
1	snodo 1/2"	920/25	MC20
1	prolunga angolare - 1/2" 125 mm	920AN/125	MC20
1	quadro scorrevole 1/4"	900/42	MC20
1	cricchetto reversibile 1/4" ®	900/55	MC20
1	bussola portainseriti	895/1	MC20

5927VUM

059270021



2700S-RVUM
(C27S R+5927VUM)

027000223



2200S-RVUM
(C22S-R+5927VUM)

022000223



2700 S-OVUM
(C27S O+5927VUM)

027000221



2200S-OVUM
(C22S-O+5927VUM)

022000221



2700S-GVUM
(C27S G+5927VUM)

027000222



2200S-GVUM
(C22S-G+5927VUM)

022000222

Universali

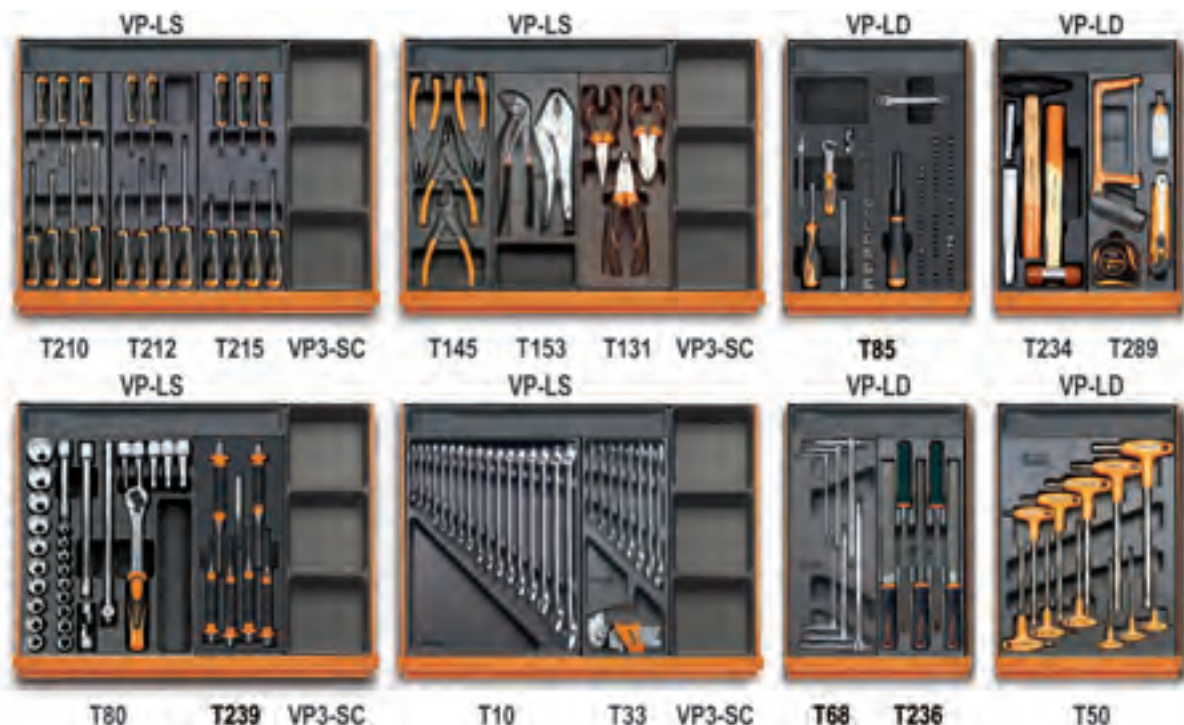

N. pezzi/Descrizione

Beta N. TR

N. pezzi/Descrizione

Beta N. TR

7	giravite lama piatta ● 2,5x50 - 3x75 - 3,5x100 - 4x125 5,5x100 - 5,5x150 - 6,5x150 mm	1201	T210	3	inserti per avvitatori per viti con impronta a croce Pozidriv® - Supadriv® ● PZ1 - PZ2 - PZ3	861PZ	T85
6	giravite Phillips® ● PH0x60-PH1x80-PH1x120-PH2x100-PH2x150-PH3x150 mm	1202	T212	4	inserti per avvitatori per viti con impronta a croce Phillips® ● PH0 - PH1 - PH2 - PH3	861PH	T85
7	chiavi maschio con impugnatura per viti con impronta Torx® ● T6-T7-T8-T9-T10-T15-T20	1207TX	T215	8	inserti maschio esagonale per avvitatori ○ 2 - 2,5 - 3 - 4 - 5 - 6 - 8 - 10 mm	861PE	T85
1	pinze becchi diritti per anelli elastici, per fori ○ 180 mm	1032	T145	7	inserti per avvitatori per viti a testa con intaglio ● 0,5x3 - 0,6x4,5 - 0,8x5,5 - 1x5,5 - 1,2x6,5 - 1,2x8 - 1,6x8 mm	861LP	T85
1	pinze becchi piegati per anelli elastici, per fori ○ 170 mm	1034	T145	2	scalpelli piatti nervati 100 - 200 mm	35	T234
1	pinze becchi diritti per anelli elastici, per alberi ● 175 mm	1036	T145	1	martello tipo tedesco 300 g	1370	T234
1	pinze becchi piegati per anelli elastici, per alberi ● 175 mm	1038	T145	1	mazzuola con battenti in materiale plastico Ø 35 mm	1390	T234
1	pinze regolabili cerniera chiusa 240 mm	1048	T153	1	flessometro 5 m	1692	T289
1	pinza autobloccante 240 mm	1052	T153	1	miniseghetto	1725CR	T289
1	tronchesi a grande effetto taglienti diagonali † 160 mm	1084BM	T131	1	oliatore in plastica	1755	T289
1	pinza universale 180 mm	1150BM	T131	1	cutter con lama a settori	1771	T289
1	pinza a becchi mezzotondi diritti ● 160 mm	1166BM	T131	19	chiavi a bussola esagonali 1/2" ○ 10 - 11 - 12+19 - 20 - 21 - 22 - 23 - 24 - 26 - 27 - 30 - 32 mm	920A	T80
1	chiave portainseriti a cricchetto reversibile 1/4x5/16	194	T85	5	chiavi a bussola maschio esagonale 1/2" ○ 5 - 6 - 8 - 10 - 12 mm	920ME	T80
13	chiavi a bussola esagonali 1/4" ○ 4-4,5-5-5,5-6-7-8-9-10-11-12-13-14 mm	900	T85	1	prolunga - 1/2" 125 mm	920/21	T80
1	cricchetto reversibile 1/4" ● 125 mm	900/55	T85	1	prolunga - 1/2" 255 mm	920/22	T80
1	quadro scorrevole 1/4" 115 mm	900/42	T85	1	snodo 1/2"	920/25	T80
1	quadro con impugnatura 1/4" 176 mm	900BG/30	T85	1	quadro maschio 1/2" con spina scorrevole	920/42	T80
1	snodo 1/4" 41 mm	900/25	T85	1	cricchetto reversibile 1/2" ●	920/55	T80
1	prolunga - 1/4" 150 mm	900/21	T85	1	bulino Ø 4 mm	32	T239
1	portainseriti a sgancio rapido con impugnatura 230 mm	851SR	T85	6	cacciaspina con impugnatura 2-3-4-5-6-8 mm	31BM	T239
5	inserti per avvitatori per viti con impronta Spanner ● 4-6-8-10-12 mm	861SP	T85	17	chiavi combinate 6-7-8-10-11-12-13-14-16-17-18-19-21-22-24-27-30 mm	42	T10
8	inserti per avvitatori per viti con impronta Torq-Set® ● 0-1-2-3-4-5-6-8 mm	861TQS	T85	8	chiavi a forchetta 6x7 - 8x9 - 10x11 - 12x13 - 14x15 - 16x17 - 18x19 - 20x22 mm	55	T33
6	inserti per avvitatori per viti con impronta Tri-Wing® ● 1-2-3-4-5-6 mm	861TRW	T85	9	chiavi maschio esagonale piegate ○	96/SC9	T33
8	inserti per avvitatori per viti con impronta Tamper Resistant Torx® ● T9-T10-T15-T20-T25-T27-T30-T40	861RTX	T85	6	chiavi a T maschio esagonale ○ 2,5 - 3 - 4 - 5 - 6 - 8 mm	951	T68
11	inserti per avvitatori per viti con impronta Torx® ● T6-T7-T8-T9-T10-T15-T20-T25-T27-T30-T40	861TX	T85	5	lime a taglio mezzodolce 200 mm	1719BMA8/S5	T236
				11	chiavi maschio esagonale con impugnatura ○ 2 - 2,5 - 3 - 3,5 - 4 - 4,5 - 5 - 6 mm	96T	T50
				4	termoformati vuoti		VP-3SCVP-3SC
				4	termoformati vuoti		VP-LS VP-LS
				4	termoformati vuoti		VP-LD VP-LD

5938U/2T

059380062



3800 G/U/2T
(C38 G+5938U/2T)

038000069

3800 O/U/2T
(C38 O+5938U/2T)

038000068



3800 R/U/2T
(C38 R+5938U/2T)

038000070

Universale



N. pezzi/Descrizione

2	punzoni 2 - 3 mm
1	bulino 4 mm
2	scalpelli piatti 125 - 150 mm
1	ugnetti 150 mm
18	chiavi combinate 6-7-8-9-10-11-12-13-14-15 16-17-18-19-20-21-22-24 mm
12	chiavi a forchetta 6x7-8x9-10x11-12x13-14x15-16x17-18x19-20x22- 21x23-24x27-25x28-30x32 mm
11	chiavi maschio esagonale con impugnatura ○ 2-2,5-3-3,5-4-4,5-5-6-7-8-10 mm
8	○ T9-T10-T15-T20-T25-T27-T30-T40
1	250 mm
21	chiavi a bussola esagonali 1/2" ○ 10-11-12-13-14-15-16-17-18-19-20- 21-22-23-24-25-26-27-28-30-32 mm
1	snodo 1/2"
1	quadro maschio 1/2" con spina scorrevole
1	cricchetto reversibile 1/2" Ⓢ
1	pinze regolabili cerniera chiusa 250 mm
1	pinza autobloccante 240 mm
1	tronchese a taglienti diagonali ≯ 160 mm
1	tronchese doppia leva taglio frontale ≯ 200 mm
1	cesoia a lame larghe diritte 200 mm
1	forbici per elettricisti lame diritte

Beta N.

30
32
34
36
42
55
96T/SP11
97TX/SC8
111G
920A
920/25
920/42
920/55
1048
1052
1082BM
1092V
1112
1128BMX

N. pezzi/Descrizione

1	pinza universale 180 mm
1	pinza a becchi mezzotondi diritti ● 160 mm
7	giravite lama piatta ● 2,5x75 - 3x75 - 4x125 - 5,5x100 - 6,5x150 - 8x200 - 10x200 mm
4	giravite per viti con impronta a croce Phillips® Ⓢ PH0x60 - PH1x80 - PH2x100 - PH3x150 mm
1	martello tipo tedesco 400 g
1	mazzuola con battenti in materiale plastico 35
1	calibro a corsoio
5	serie di 5 lime
1	seghetto 440 mm
1	cutter con lama a settori
1	pinze becchi diritti per anelli elastici, per fori ○ 180 mm
1	pinze becchi piegati per anelli elastici, per fori ○ 170 mm
1	pinze becchi diritti per anelli elastici, per alberi ● 175 mm
1	pinze becchi piegati per anelli elastici, per alberi ● 175 mm

Beta N.

1150BM
1166BM
1260
1262
1370
1390
1650
1719BMA/S5
1726
1771BM
1032
1034
1036
1038

Universali



21,3 kg

N. pezzi/Descrizione

- 6 cacciaspina Ø 2 - 3 - 4 - 5 - 6 - 8 mm
- 6 2 punzoni, 1 bulino, 3 scalpelli con supporto
- 19 chiavi combinate 6+22 - 24 - 27 mm
- 12 chiavi poligonali curve 6x7+30x32 mm
- 12 chiavi maschio esagonale piegate Ø 2=10 mm
- 1 chiave regolabile a rullino 250 mm
- 13 chiavi a bussola poligonali 1/2" con guida Ø 10+22 mm
- 8 chiavi a bussola poligonali 1/2" con guida Ø 23+32 mm
- 4 chiavi a bussola a giravite lama piatta 1/2" ● 1,2x6,5 - 1,2x8 - 1,6x9 - 2x12 mm
- 3 chiavi a bussola a giravite lama Phillips® 1/2" ⚙ PH2 - 3 - 4
- 1 prolunga - 1/2" 125 mm
- 1 prolunga - 1/2" 255 mm
- 1 snodo 1/2"
- 1 quadro maschio snodato 1/2" con impugnatura
- 1 quadro maschio 1/2" con spina scorrevole
- 1 cricchetto reversibile 1/2" ⚙
- 1 leva con estremità a punta e punta curva
- 1 pinzetta punte fini curve 130 mm
- 1 pinzetta punte larghe diritte 150 mm
- 1 pinze becchi dritti per anelli elastici, per fori Ø 180 mm
- 1 pinze becchi piegati per anelli elastici, per fori Ø 170 mm
- 1 pinze becchi dritti per anelli elastici, per alberi ● 175 mm
- 1 pinze becchi piegati per anelli elastici, per alberi ● 175 mm

Beta N.

- 31/SP6
- 38/SP6
- 42
- 90/S12X
- 96/SC12
- 111
- 920B/SB13
- 920B/SB8
- 920LP
- 920PH
- 920/21
- 920/22
- 920/25
- 920/35A
- 920/42
- 920/55
- 963
- 991
- 994
- 1032
- 1034
- 1036
- 1038

N. pezzi/Descrizione

- 1 pinze regolabili cerniera chiusa 250 mm
- 1 pinza autobloccante a doppia regolazione
- 1 tronchesi a grande effetto taglienti diagonali \angle 160 mm
- 1 tronchesi doppia leva taglio frontale \angle 180 mm
- 1 cesoia a lame larghe diritte 250 mm
- 1 cesoia a lame strette diritte 250 mm
- 1 forbici per elettricisti lame diritte
- 1 pinza universale 180 mm
- 1 pinza a becchi mezzotondi dritti ● 160 mm
- 1 pinza a becchi mezzotondi piegati ● 200 mm
- 7 giravite lama piatta ● 3x75 - 3,5x100 - 4x125 - 5,5x150 - 6,5x150 - 10x200 - 12x250 mm
- 1 giravite lama piatta con esagono di manovra ● 12x250 mm
- 3 giravite per viti con impronta a croce Phillips® ⚙ PH0x60 - PH1x80 - PH2x100 mm
- 2 martello tipo tedesco 300 - 600 g
- 1 mazzuola con battenti in materiale plastico Ø 35 mm
- 1 flessometro 5 m
- 1 flessibile magnetico 1,8 kg
- 1 raschietto a due taglienti 200 mm
- 1 raschietto a tre taglienti 200 mm
- 5 lime a taglio mezzodolce 200 mm
- 1 seghetto
- 1 oliatore in metallo a pressione 200 cc

Beta N.

- 1048
- 1051
- 1084BM
- 1092V
- 1112
- 1114
- 1128BMX
- 1150BM
- 1166BM
- 1168BM
- 1260
- 1260E
- 1262
- 1370
- 1390
- 1692
- 1712E/2
- 1717A
- 1717B
- 1719BMA/S5
- 1725
- 1751

5957U

059570026

5700SP O/U
(C57SP O+5957U)

057001075

5700SP G/U
(C57SP G+5957U)

057001275

5700SP R/U
(C57SP R+5957U)

057001475

Universali

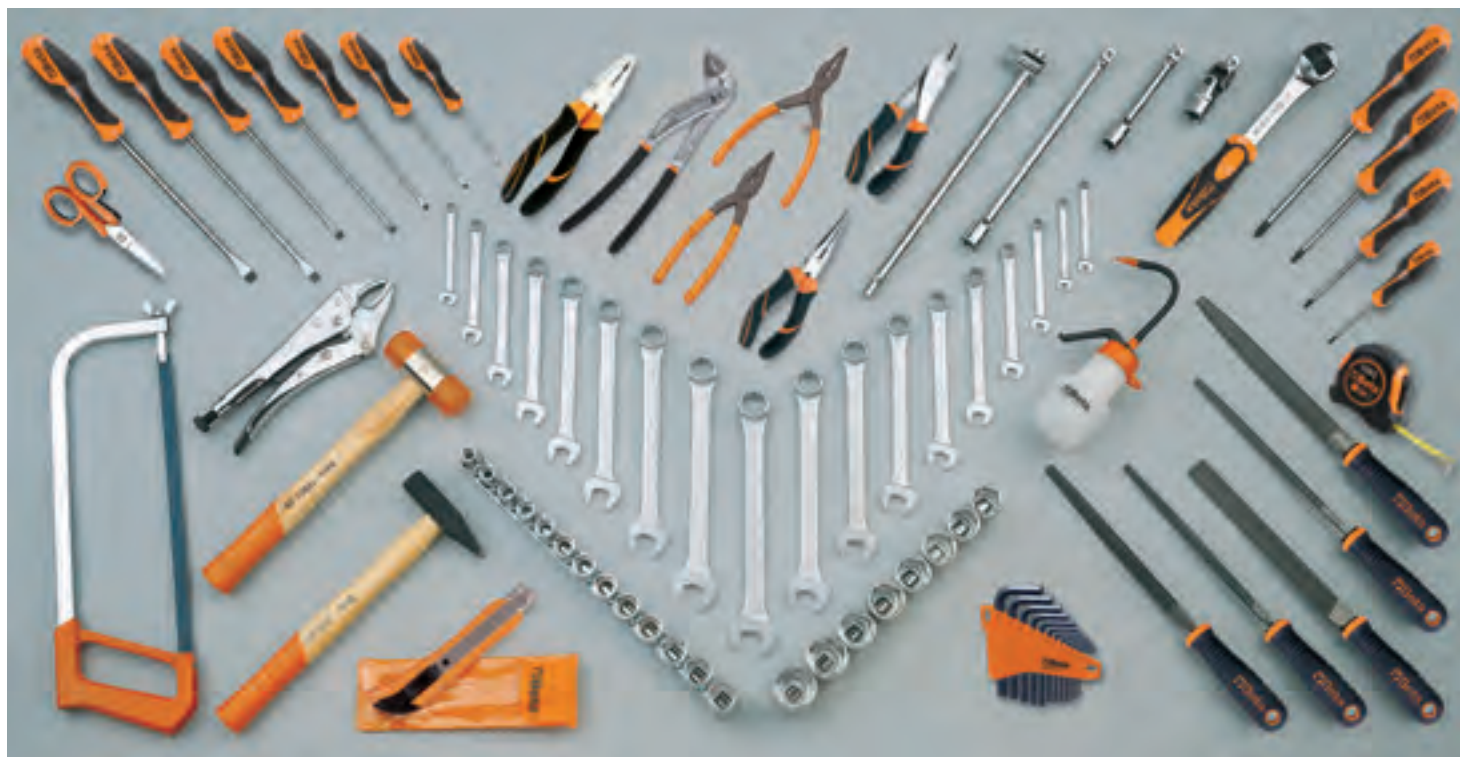

11,3 kg

N. pezzi/Descrizione

18	chiavi combinate 5,5+22 mm
12	chiavi maschio esagonale piegate \varnothing 2+10 mm
13	chiavi a bussola esagonali 1/2" con guida \varnothing 10+22 mm
8	chiavi a bussola esagonali 1/2" con guida \varnothing 23+32 mm
1	prolunga - 1/2" 125 mm
1	prolunga - 1/2" 255 mm
1	snodo 1/2"
1	quadro maschio 1/2" con spina scorrevole
1	cricchetto reversibile 1/2" \otimes
1	pinze becchi dritti per anelli elastici, per fori \varnothing 180 mm
1	pinze becchi dritti per anelli elastici, per alberi \bullet 175 mm
1	pinze regolabili cerniera chiusa 250 mm
1	pinza autobloccante 240 mm
1	tronchese a grande effetto taglienti diagonali ∇ 160 mm
1	forbici per elettricisti lame diritte
1	pinza universale 180 mm

Beta N.

42
96N/SC12
920A/SB13
920A/SB8
920/21
920/22
920/25
920/42
920/55
1032
1036
1048
1052
1084BM
1128BMX
1150BM

N. pezzi/Descrizione

1	pinza a becchi mezzotondi dritti \bullet 160 mm
7	giravite lama piatta \bullet 3x75 - 3,5x100 - 4x125 5,5x150 - 6,5x150 - 8x200 - 10x200 mm
4	giravite Phillips® \oplus PH0x60 - PH1x80 PH2x100 - PH3x150 mm
1	martello tipo tedesco 300 g
1	mazzuola con battenti in materiale plastico \varnothing 35 mm
1	flessometro 5 m
5	lime a taglio mezzodolce 200 mm
1	seghetto
1	oliatore in plastica a pressione 150 cc
1	cutter con lama a settori

Beta N.

1166BM
1260
1262/S4
1370
1390
1692
1719BMA/S5
1725
1754
1771

5958U

059580024

5800 P-G
(C58P G+5958U)

058000182

5800 P-R
(C58P R+5958U)

058000183

 5800 P-O
(C58P O+5958U)

058000181

Elettrotecnica



7,9 kg

N. pezzi/Descrizione

- 1 bulino Ø 4 mm
- 2 scalpelli piatti nervati 125 - 200 mm
- 8 chiavi a forchetta 6x7 - 8x9 - 10x11 - 12x13 - 14x15 - 16x17 - 18x19 - 20x22 mm
- 8 chiavi maschio esagonale, tipo lungo \odot 1,5÷12 mm
- 1 chiave regolabile a rullino 200 mm
- 10 inserti con portainseri magnetico \bullet \oplus \ominus
- 1 pinze regolabili a cerniera chiusa 250 mm
- 1 tronchesi a taglienti diagonali ∇ 160 mm
- 1 forbici per elettricisti lame diritte con svasatore
- 1 tagliacavo 170 mm
- 1 pinza spellafili ∇ 160 mm
- 1 pinza universale 180 mm
- 1 pinza a becchi mezzotondi dritti \bullet 160 mm
- 1 pinza a becchi mezzotondi piegati \bullet 160 mm
- 1 giravite prensile lama piatta \bullet 4x125 mm
- 1 giravite prensile Phillips® \oplus PH1x150 mm

Beta N.

- 32
- 35
- 55/B8
- 96LC/SC8
- 111
- 860MIX/A10
- 1048BMQ
- 1082BM
- 1128BSX
- 1132BM
- 1142BM
- 1150BM
- 1166BM
- 1168BM
- 1250
- 1251

N. pezzi/Descrizione

- 1 giravite cercafase \bullet 1253
- 5 giravite lama piatta \bullet 2,5x75 - 3,5x100 - 5,5x125 - 6,5x150 mm 1201
- 1 giravite per viti a testa con intaglio \bullet 4x30 mm 1201N
- 4 giravite Phillips® \oplus PH0x60 - PH1x120 - PH2x150 - PH3x150 mm 1202
- 1 giravite Phillips® \oplus PH2x30 mm 1202N
- 4 giravite Phillips® 1000V \oplus PH0x60 - PH1x80 - PH2x100 - PH3x150 mm 1272MQ
- 5 giravite lama parallela 1000V \bullet 5,5x125 - 3x100 - 4x100 - 6,5x150 - 8x175 mm 1274MQ
- 1 martello tipo tedesco 300 g 1370
- 1 mazzuola con battenti in materiale plastico Ø 35 mm 1390
- 1 pinza per capicorda preisolati 1602
- 1 nastro isolante 25 m 1639NS-N
- 1 flessometro 5 m 1692
- 1 lima 200 mm 1719BMA/M
- 1 lima 200 mm 1719BMA/R
- 1 seghetto 1725
- 1 coltello a serramanico 1777BM

5980ET/A 059800262

2032ET/A 020320118
(2032/VV+5980ET/A)

2032TET/A 020320228
(2032/TV+5980ET/A)

2112ET/A 021120128
(C12+5980ET/A)

Elettrotecnica



8,7 kg

N. pezzi/Descrizione

3	cacciaspina Ø 2 - 3 - 4 mm	Beta N.	31
1	bulino Ø 4 mm		32
1	scalpelli piatti 150 mm		34
8	chiavi a forchetta 6x7 - 8x9 - 10x11 - 12x13 - 14x15 - 16x17 18x19 - 20x22 mm		55/B8
9	chiavi maschio esagonale piegate con estremità sferica Ø 1,5 - 2 - 2,5 - 3 - 4 - 5 - 6 - 8 - 10 mm	96BPC/SC9	
1	sbavatore a raschietto 150 mm		345SB
6	chiavi a bussola esagonale con impugnatura 1000V Ø 5,5 - 6 - 7 - 8 - 10 - 13 mm	943MQ/S6	
1	pinze regolabili a cerniera chiusa 250 mm		1048MQ
1	tronchesi a taglienti diagonali 1000V \nlessgtr 160 mm		1082MQ
1	forbici per elettricisti lame diritte con svasatore		1128BSX
1	tagliacavi 230 mm		1132MQ
1	pinze spellafili \nlessgtr 160 mm		1142MQ
1	pinza universale 1000V \nlessgtr 180 mm		1150MQ
1	pinze a becchi mezzotondi lunghissimi 1000V \bullet 160 mm		1166MQ
1	giravite cercafase \bullet		1253
3	giravite Phillips® 1000V \oplus PH0x60 - PH1x80 - PH2x100 mm		1272MQ
4	giravite lama parallela 1000V \bullet 3x100 - 4x100 - 5,5x125 - 6,5x150 mm		1274MQ

N. pezzi/Descrizione

1	martello tipo tedesco 300 g	Beta N.	1370
1	mazzuola con battenti in materiale plastico Ø 35 mm		1390
1	pinza per capicorda preisolati		1602
1	riga flessibile graduata 250 mm		1682
1	punta per tracciare 250 mm		1688
1	flessometro 5 m		1692
1	livella in alluminio 200 mm		1696
1	scalpello per elettricisti 10x200 mm	1701NE/3	
1	traccialinea		1705
1	specchietto flessibile 600 mm		1715FL/A
1	200 mm	1719BMA/M	
1	lime a taglio mezzodolce 200 mm	1719BMA/R	
1	tenditore per molle		1723
1	seghetto		1726BM
1	pennello		1738
1	pinza per collari in Nylon		1743
1	oliatore in plastica 80 cc		1755
100	collari in Nylon 3,6x200 mm		1748/8K
100	collari in Nylon 4,8x300 mm		1748/17K
1	cutter con lama a settori		1771BM
1	saldatore 30 W		1814M
1	torcia LED		1835/2

5980ET/B

059800263

2029ET/B

(2029/VV+5980ET/B)

020290221

2036ET/B

(2036/TV+5980ET/B)

020360123

2112ET/B

(C12+5980ET/B)

021120129

2033P ET/B

(2033P/VV+5980ET/B)

020330127

Elettrotecnica



7 kg

N. pezzi/Descrizione

- 7 chiavi a forchetta 1000V 10 - 12 - 13 - 14 - 17 - 19 - 22 mm
- 1 chiave regolabile a rullino 1000V 250 mm
- 6 chiavi a bussola esagonale con impugnatura
○ 5,5 - 6 - 7 - 8 - 10 - 13 mm
- 4 chiavi a T maschio esagonale ○ 4 - 5 - 6 - 8 mm
- 1 pinze regolabili a cerniera chiusa
- 1 tronchesi a taglienti diagonali 1000V \leq 160 mm
- 1 forbici per elettricisti
- 1 pinze spellafili \leq 160 mm
- 1 pinza universale 1000V \equiv 180 mm
- 1 pinze a becchi mezzotondi lunghissimi 1000V \bullet 160 mm
- 1 giravite cercafase \bullet

Beta N.

- 52MQ
- 110MQ
- 943MQ
- 951MQ
- 1048MQ
- 1082MQ
- 1128MQ
- 1142MQ
- 1150MQ
- 1166MQ
- 1253

N. pezzi/Descrizione

- 4 giravite Phillips® 1000V
⊕ PH0x60 - PH1x80 - PH2x100 - PH3x150 mm
- 5 giravite lama parallela 1000V
● 3x100 - 4x100 - 5,5x125 - 6,5x150 - 8x175 mm
- 1 mazzuola con battenti in materiale plastico \varnothing 35 mm
- 1 miniseghetto 1000V
- 1 cutter 1000V
- 1 saldatore 30 W
- 1 tester combinato di tensione e di continuità
- 1 pinze a becchi piatti lunghissimi piegati \equiv 160 mm
- 1 martello tipo tedesco 300 g
- 1 flessometro 5 m
- 1 scalpello per elettricisti 200 mm
- 1 torcia LED ad alta luminosità

Beta N.

- 1272MQ
- 1274MQ
- 1390
- 1725MQ
- 1777MQ
- 1814M
- 1847P
- 1164MQ
- 1370
- 1692
- 1701NE/3
- 1834PS

5980/MQ

059800256

2029BG-MQ
(2029/VV+5980/MQ)

020290256

Elettronica



2,6 kg

N. pezzi/Descrizione

- 13 chiavi a forchetta piccole 4+14 mm
- 9 chiavi maschio esagonale piegate \varnothing 1,5+10 mm
- 1 pinzetta punte fini curve 130 mm
- 1 pinzetta punte fini diritte 150 mm
- 1 pinzetta becchi dritti incrociati 155 mm
- 1 forbici per elettricisti lame diritte con svasatore
- 1 pinza spellafili \downarrow 160 mm
- 1 pinza a becchi mezzotondi dritti \bullet 160 mm
- 1 pinza a becchi piatti lunghi \equiv
- 1 pinza a becchi mezzotondi lunghi piegati \bullet
- 1 pinza universale per elettronica \bullet
- 1 tronchese a taglienti diagonali rasi \downarrow
- 1 tronchese a taglienti diagonali normali \downarrow
- 1 giravite prensile lama piatta \bullet 4x125 mm

Beta N.

- 73/B13
- 96N/SC9
- 991
- 992
- 998
- 1128BSX
- 1142BM
- 1166BM
- 1172BM
- 1178BM/P
- 1178BM
- 1185BM
- 1188BM
- 1250

N. pezzi/Descrizione

- 1 giravite prensile Phillips® \oplus PH0x125 mm
- 8 microgiraviti
- 1 martello tipo tedesco 200 g
- 1 flessometro 5 m
- 1 specchietto telescopico
- 3 lime ad ago
- 1 tenditore per molle
- 1 pennello
- 1 oliatore a stilo
- 1 cutter con lama a settori
- 1 pinzetta autobloccante
- 1 saldatore 25 W
- 1 pompetta succhiastagno
- 1 torcia LED

Beta N.

- 1251
- 1257LPH /S8
- 1370
- 1692
- 1715
- 1720/S3
- 1723
- 1738
- 1756
- 1771
- 1779
- 1814M
- 1830T
- 1835/2

5980 EL/A

059800241

2033P EL/A
(2033P/VV+5980EL/A)

020330114

2032EL/A
(2032/VV+5980EL/A)

020320114

2032TEL/A
(2032/TV+5980EL/A)

020320214

Elettronica



4,8 kg

N. pezzi/Descrizione

13	chiavi a forchetta piccole 4÷14 mm
9	chiavi maschio esagonale piegate \odot 1,5÷10 mm
8	chiavi maschio con impronta Torx® \odot T9 - T10 - T15 - T20 - T25 - T27 - T30 - T40
1	chiave regolabile a rullino 150 mm
18	assortimento 13 bussole e 5 accessori 1/4"
1	pinzetta a molla a punte fini diritte 130 mm
1	pinzetta punte fini curve 130 mm
1	pinzetta a molla a punte corte finissime 120 mm
1	forbici per elettricisti lame diritte
1	pinza spellafili frontale autoregolabile 170 mm
1	pinza universale 180 mm
1	pinza a becchi piatti lunghi \equiv 140 mm
1	pinza a becchi mezzotondi lunghi lisci \bullet 140 mm
1	pinza a becchi mezzotondi lunghi piegati \bullet 140 mm
1	tronchese a taglienti diagonali rasi becchi arrotondati ζ 120 mm
1	tronchese a taglienti diagonali rasi becchi assotigliati ζ 120 mm
1	tronchese a taglienti frontali obliqui rasi ζ
8	microgiraviti
1	giravite cercafase \bullet
1	giravite nano lama piatta \bullet 6,5x30 mm

Beta N.

73/B13
96/SC9
97TX/BG8
111
900/C13-5
990
991
999A
1128BMX
1149F
1150BM
1172BM
1177BM
1178BM/P
1184BM
1186BM
1191BM
1257LPH/S8
1253
1290N

N. pezzi/Descrizione

3	giravite Phillips® \oplus PH0x60 - PH1x80 - PH2x100 mm
2	giravite nano Phillips® \oplus PH1x30 - PH2x30 mm
5	giravite lama parallela \bullet 2,5x60 - 3x75 - 4x100 - 5x125 - 6,5x150 mm
1	martello tipo tedesco 200 g
1	riga flessibile graduata 150 mm
1	punta per tracciare 220 mm
1	flessometro 5 m
1	specchietto telescopico 670 mm
1	lime ad ago \blacktriangle
1	lime ad ago \blacktriangle
1	lime ad ago \blacksquare
1	tenditore per molle
1	pennello
1	oliatore a stilo
1	cutter con lama a settori
1	coltello a serramanico
1	pinzetta autobloccante
1	saldatore 25W
1	pompette succhiastagno
1	torcia LED

Beta N.

1292
1292N
1294
1370
1682
1688
1692
1715
1720R
1720T
1720P
1723
1738
1756
1771BM
1777BM
1779
1814M
1830T
1835/2

5980 EL/B

059800242

2033P EL/B
(2033P/VV+5980EL/B)

020330115

2029EL/B
(2029/VV+5980EL/B)

020290217

2036 EL/B
(2036/TV+5980EL/B)

020360118

Idraulica



11,6 kg

N. pezzi/Descrizione

- 1 scalpelli piatti 150 mm
- 1 scalpelli piatti nervati 200 mm
- 12 chiavi a forchetta 6x7 - 8x9 - 10x11 - 12x13 - 14x15 - 16x17 - 18x19 - 20x22 - 21x23 - 24x27 - 25x28 - 30x32 mm
- 1 chiave regolabile a rullino 250 mm
- 1 tagliatubi per rame e leghe leggere Ø 3+30 mm
- 1 giratubi svedese 320 mm
- 1 pinze regolabili cerniera chiusa 250 mm
- 1 pinza autobloccante 240 mm
- 1 cesoia a lame larghe diritte 300 mm
- 1 forbici per elettricisti lame diritte

Beta N.

- 34
- 35
- 55/S12X
- 111
- 334
- 374
- 1048
- 1052
- 1112
- 1128BMX

N. pezzi/Descrizione

- 1 pinza universale 180 mm
- 4 giravite lama piatta 3x75 - 4x100 - 5,5x150 - 8x150 mm
- 2 giravite Phillips PH1x80 - PH2x100 mm
- 1 martello tipo tedesco 300 g
- 1 metro pieghevole in fibra 2 m
- 1 flessometro 5 m
- 1 livella in alluminio 200 mm
- 1 lime a taglio mezzodolce 200 mm
- 1 seghetto
- 1 spazzola fili d'acciaio

Beta N.

- 1150BM
- 1201
- 1202
- 1370
- 1690F
- 1692
- 1696A
- 1719BMA/M
- 1725
- 1737NX

5980ID

059800321

2009ID
(2009N/BV+5980ID)

020090012

Autoriparazione



28,6 kg

N. pezzi/Descrizione

- 2 punzoni Ø 3 - 4 mm
- 2 cacciaspina Ø 6 - 8 mm
- 1 bulino Ø 4 mm
- 2 scalpelli piatti nervati 150 - 200 mm
- 18 chiavi combinate 6÷14 - 17 - 19 - 22 - 24 - 27 - 30 - 32 - 36 - 41 mm
- 10 chiavi poligonali curve 6x7 - 8x9 - 10x11 - 12x13 - 14x15 - 16x17 - 18x19 - 20x22 - 24x27 - 30x32 mm
- 10 chiavi maschio esagonale piegate \odot 1,5÷12 mm
- 17 chiavi a bussola esagonali 1/2" \odot 10÷22 - 24 - 27 - 30 - 32 mm
- 1 prolunga - 1/2" 125 mm
- 1 prolunga - 1/2" 255 mm
- 1 snodo 1/2"
- 1 quadro maschio 1/2" con spina scorrevole
- 1 cricchetto con quadro scorrevole 1/2" \otimes
- 11 chiavi a bussola esagonali 3/4" \odot 22 - 24 - 27 - 30 - 32 - 36 - 41 - 46 - 50 - 55 - 60 mm
- 1 prolunga - 3/4" 200 mm
- 1 quadro maschio snodato 3/4" con impugnatura
- 1 quadro maschio 3/4" con spina scorrevole
- 1 cricchetto reversibile 3/4" \otimes

Beta N.

- 30
- 31
- 32
- 35
- 42
- 90
- 96N/B10
- 920A
- 920/21
- 920/22
- 920/25
- 920/42
- 920/50
- 928A
- 928/21
- 928/36A
- 928/42
- 928/55

N. pezzi/Descrizione

- 1 leva con estremità a punta e a becco
- 1 pinze regolabili cerniera chiusa 250 mm
- 1 pinza autobloccante ganasce sagomate
- 1 tronchesi a grande effetto taglienti diagonali \nlessgtr 160 mm
- 1 forbici per elettricisti lame diritte
- 1 pinza universale 180 mm
- 1 pinza a becchi mezzotondi dritti \bullet 160 mm
- 4 giravite lama piatta con esagono di manovra \bullet 6,5x150 - 8x175 - 10x200 - 12x250 mm
- 3 giravite Phillips® con esagono di manovra \oplus PH2x150 - PH3x175 - PH4x200 mm
- 1 martello testa tonda penna sferica 900 g
- 1 mazzuola con battenti in materiale plastico Ø 35 mm
- 1 spessimetro
- 1 raschietto a tre taglienti 200 mm
- 5 lime a taglio mezzodolce 200 mm
- 1 seghetto

Beta N.

- 964
- 1048
- 1055
- 1084BM
- 1128BMX
- 1150BM
- 1166BM
- 1260E
- 1262E
- 1377
- 1390
- 1708/20
- 1717B
- 1719BMA/S5
- 1725

5902MT

059020043



2200S-G/MT
(C22S-G+5902MT)

022000432

2200S-O/MT
(C22S-O+5902MT)

022000431



2200S-R/MT
(C22S-R+5902MT)

022000433

Autoriparazione



27,3 kg

N. pezzi/Descrizione

- 2 punzoni Ø 3 - 4 mm
- 2 cacciapina Ø 6 - 8 mm
- 1 bulino Ø 4 mm
- 2 scalpelli piatti nervati 150 - 200 mm
- 20 chiavi combinate 1/4+1.1/2"
- 6 chiavi poligonali curve 1/4x5/16 - 3/8x7/16 - 1/2x9/16 5/8x3/4 - 11/16x13/16 - 7/8x15/16"
- 11 chiavi maschio esagonale piegate O 3/64+3/8"
- 10 chiavi a bussola poligonali □ 1/2" O 7/16 - 1/2 - 9/16 5/8 - 11/16 - 3/4 - 13/16 - 7/8 - 15/16 - 1"
- 1 prolunga - 1/2" 125 mm
- 1 prolunga - 1/2" 255 mm
- 1 snodo 1/2"
- 1 quadro maschio 1/2" con spina scorrevole
- 1 cricchetto con quadro scorrevole 1/2" Ⓢ
- 12 chiavi a bussola esagonali O □ 3/4", 7/8 - 15/16 - 1 - 1.1/16 - 1.1/8 - 1.1/4 - 1.5/16 1.1/2 - 1.5/8 - 1.11/16 - 1.7/8 - 2"
- 1 prolunga - 3/4" 200 mm
- 1 quadro maschio snodato 3/4" con impugnatura
- 1 quadro maschio 3/4" con spina scorrevole
- 1 cricchetto reversibile 3/4" Ⓢ

Beta N.

- 30
- 31
- 32
- 35
- 42AS
- 90AS
- 96AS/B11
- 920AS
- 920/21
- 920/22
- 920/25
- 920/42
- 920/50
- 928AS
- 928/21
- 928/36A
- 928/42
- 928/55

N. pezzi/Descrizione

- 1 leva con estremità a punta e a becco
- 1 pinze regolabili cerniera chiusa 250 mm
- 1 pinza autobloccante ganasce sagomate
- 1 tronchesi a grande effetto taglianti diagonali $\leq 160\text{ mm}$
- 1 forbici per elettricisti lame diritte
- 1 pinza universale 180 mm
- 1 pinza a becchi mezzotondi diritti ● 160 mm
- 4 giravite lama piatta con esagono di manovra ● 6,5x150 - 8x175 - 10x200 - 12x250 mm
- 3 giravite Phillips® con esagono di manovra ⚙ PH2x150 - PH3x175 - PH4x200 mm
- 1 martello testa tonda penna sferica 900 g
- 1 mazzuola con battenti in materiale plastico Ø 35 mm
- 1 spessimetro 150 - 200 mm
- 1 raschietto a tre taglianti 200 mm
- 5 lime a taglio mezzodolce 200 mm
- 1 seghetto

Beta N.

- 964
- 1048
- 1055
- 1084BM
- 1128BMX
- 1150BM
- 1166BM
- 1260E
- 1262E
- 1377
- 1390
- 1708/20
- 1717B
- 1719BMA/S5
- 1725

5902MT/AS

059020044

2200S-G/MTAS

022000442

2200S-O/MTAS
(C22S-O+5902MT/AS)

022000441

2200S-R/MTAS
(C22S-R+5902MT/AS)

022000443

5904VG/1M

assortimento di 76 utensili in termoformato morbido

Autoriparazione



N. pezzi/Descrizione

16	chiavi combinate 6÷21 mm	42	M15
5	chiavi combinate 22 - 24 - 27 - 30 - 32 mm	42	M16
1	tronchesi a grande effetto taglienti diagonali 160 mm	1084	M132
1	pinza universale 180 mm	1150	M132
1	pinza a becchi mezzotondi dritti 160 mm	1166	M132
8	chiavi maschio esagonale con impugnatura 2-2,5-3-4-5-6-7-8 mm	96T	M50
6	chiavi maschio con impugnatura per viti con impronta Torx® T10-T15-T20-T25-T27-T30	97TTX	M55
4	giravite lama piatta 3x75 - 4x100 - 5,5x150 - 6,5x150 mm	1201	M220
3	giravite Phillips® PH0x60 - PH1x80 - PH2x100 mm	1202	M220
1	prolunga angolare - 1/2" 125 mm	920AN/125	M83
1	prolunga angolare - 1/2" 250 mm	920AN/250	M83

Beta N.

TR

N. pezzi/Descrizione

1	snodo 1/2"	920/25	M83
1	quadro maschio 1/2" con spina scorrevole	920/42	M83
1	cricchetto reversibile 1/2"	920/55	M83
19	chiavi a bussola esagonali 1/2" 10÷24 - 26 - 27 - 30 - 32 mm	920A	M83
1	pinze becchi dritti per anelli elastici, per fori 180 mm	1032	M145
1	pinze becchi piegati per anelli elastici, per fori 170 mm	1034	M145
1	pinze becchi dritti per anelli elastici, per alberi 175 mm	1036	M145
1	pinze becchi piegati per anelli elastici, per alberi 175 mm	1038	M145
2	scalpelli piatti nervati 100 - 200 mm	35	M234
1	martello tipo tedesco 300 g	1370	M234
1	mazzuola con battenti in materiale plastico Ø 35 mm	1390	M234

Beta N.

TR

	5904VG/1M		2300ST-GVG1M (C23STG+5904VG/1M)
	059040197		023000686
	2300ST-QVG1M (C23STO+5904VG/1M)		2300ST-RVG1M (C23STR+5904VG/1M)
	023000685		023000687

Autoriparazione



M15 M16 VP/M3



M50 M55 M86



M208 M85 M234



M83 M131 M145

N. pezzi/Descrizione

- 16 chiavi combinate 6÷21 mm
- 5 chiavi combinate 22 - 24 - 27 - 30 - 32 mm
- 8 chiavi maschio esagonale con impugnatura \odot 2-2,5-3-4-5-6-7-8 mm
- 6 chiavi maschio con impugnatura per viti con impronta Torx® \odot T10-T15-T20-T25-T27-T30
- 7 inserti maschio esagonale \odot 4-5-6-7-8-10-12 mm
- 7 inserti maschio esagonale \odot 4-5-6-7-8-10-12 mm
- 5 inserti a profilo XZN® \odot 5-6-8-10-12 mm
- 5 inserti a profilo XZN® \odot 5-6-8-10-12 mm
- 7 inserti per viti con impronta Torx® \odot T20-T25-T30-T40-T45-T50-T55
- 6 inserti per viti con impronta Torx® \odot T25-T30-T40-T45-T50-T55
- 7 inserti per viti con impronta Tamper Resistant Torx® \odot T20-T25-T30-T40-T45-T50-T55
- 1 bussole portainseri per 867
- 1 bussole portainseri per 867
- 5 giravite lama piatta \bullet 3x75 - 4x100 - 4x125 - 5,5x150 - 6,5x150 mm
- 3 giravite per viti con impronta a croce Phillips® \oplus PH0x60 - PH1x80 - PH2x100 mm
- 1 giravite nano lama piatta \bullet 4x30 mm
- 1 giravite nano Phillips® \oplus PH1x30 mm
- 5 inserti colorati per avvitatori per viti a testa con intaglio \bullet 0,5x3 - 0,6x4,5 - 0,8x5,5 - 1x5,5 - 1,2x6,5 mm
- 8 inserti colorati maschio esagonale per avvitatori \odot 2 - 2,5 - 3 - 4 - 5 - 6 - 8 - 10 mm
- 5 inserti colorati per avvitatori per viti con impronta a croce Phillips® \oplus PH0 - PH1 - PH2 - PH3 - PH4

Beta N. TR

- 42 **M15**
- 42 **M16**
- 96T **M50**
- 97TTX **M55**
- 867PE **M86**
- 867PE/L **M86**
- 867XZN **M86**
- 867XZN/L **M86**
- 867TX **M86**
- 867TX/L **M86**
- 867RTX **M86**
- 867/1 **M86**
- 867/2 **M86**
- 1260 **M208**
- 1262 **M208**
- 1262N **M208**
- 860LP **M85**
- 860PE **M85**
- 860PH **M85**

N. pezzi/Descrizione

- 4 inserti colorati per avvitatori per viti con impronta a croce Pozidriv® - Supadriv® \odot PZ1 - PZ2 - PZ3 - PZ4
- 10 inserti colorati per avvitatori per viti con impronta Torx® \odot T7-T8-T9-T10-T15-T20-T25-T27-T30-T40
- 8 inserti colorati per avvitatori per viti con impronta Tamper Resistant Torx® \odot T9-T10-T15-T20-T25-T27-T30-T40
- 1 portainseri a sgancio rapido con impugnatura 230 mm
- 1 cricchetto reversibile portainseri 100 mm
- 2 scalpelli piatti nervati 100 - 200 mm
- 1 martello tipo tedesco 300 g
- 1 mazzuola con battenti in materiale plastico \varnothing 35 mm
- 1 prolunga angolare - 1/2" 125 mm
- 1 prolunga angolare - 1/2" 250 mm
- 1 snodo 1/2"
- 1 quadro maschio 1/2" con spina scorrevole
- 1 cricchetto reversibile 1/2" \oplus
- 19 chiavi a bussola esagonali 1/2" \odot 10÷24 - 26 - 27 - 30 - 32 mm
- 1 pinza universale 180 mm
- 1 pinza a becchi mezzotondi dritti \bullet 160 mm
- 1 tronchesi a grande effetto taglienti diagonali \angle 160 mm
- 1 pinze becchi dritti per anelli elastici, per fori \odot 180 mm
- 1 pinze becchi piegati per anelli elastici, per fori \odot 170 mm
- 1 pinze becchi dritti per anelli elastici, per alberi \bullet 175 mm
- 1 pinze becchi piegati per anelli elastici, per alberi \bullet 175 mm
- 1 termoformato morbido con 3 vaschette portaminuterie

Beta N. TR

- 860PZ **M85**
- 860TX **M85**
- 860RTX **M85**
- 851SR **M85**
- 860/55 **M85**
- 35 **M234**
- 1370 **M234**
- 1390 **M234**
- 920AN/125 **M83**
- 920AN/250 **M83**
- 920/25 **M83**
- 920/42 **M83**
- 920/55 **M83**
- 920A **M83**
- 1150BM **M131**
- 1166BM **M131**
- 1084BM **M131**
- 1032 **M145**
- 1034 **M145**
- 1036 **M145**
- 1038 **M145**
- VPM3 **VPM3**

5904 VG/2M

059040198



2400S7-G/VG2M
(C24S7/G+5904VG/2M)

024002775



2400S7-O/VG2M
(C24S7/O+5904VG/2M)

024002774

2400S7-R/VG2M
(C24S7/R+5904VG/2M)

024002776

5904VG/2T

assortimento di 99 utensili in termoformato

Autoriparazione



14.5 kg

N. pezzi/Descrizione

16	chiavi combinate 6÷21 mm
5	chiavi combinate 22 - 24 - 27 - 30 - 32 mm
19	chiavi a bussola esagonali 1/2"
	○ 10+24 - 26 - 27 - 30 - 32 mm
5	chiavi a bussola maschio esagonale 1/2"
	○ 5 - 6 - 8 - 10 - 12 mm
1	prolunga - 1/2" 125 mm
1	prolunga - 1/2" 255 mm
1	snodo 1/2"
1	quadro maschio 1/2" con spina scorrevole
1	cricchetto reversibile 1/2" ⊕
1	pinze regolabili cerniera chiusa 250 mm
1	pinza autobloccante 240 mm
1	tronchesi a grande effetto taglienti diagonali 160 mm
1	pinza a becchi mezzotondi dritti 160 mm
1	pinza universale 180 mm
1	pinze becchi dritti per anelli elastici, per fori ○ 180 mm
1	pinze becchi dritti per anelli elastici, per alberi ● 175 mm

Beta N. TR N. pezzi/Descrizione

42	T15
42	T16
920A	T80
920ME	T80
920/21	T80
920/22	T80
920/25	T80
920/42	T80
920/55	T80
1048	T153
1052	T153
1084	T132
1166	T132
1150	T132
1032	T145
1036	T145

N. pezzi/Descrizione Beta N. TR

1	pinze becchi piegati per anelli elastici, per fori ○ 170 mm	1034	T145
1	pinze becchi piegati per anelli elastici, per alberi ● 175 mm	1038	T145
2	scalpelli piatti nervati 100 - 200 mm	35	T234
1	martello tipo tedesco 300 g	1370	T234
1	mazzuola con battenti in materiale plastico Ø 35 mm	1390	T234
4	giravite lama piatta ● 3x75 - 4x100 - 5,5x150 - 6,5x150 mm	1260	T208
3	giravite per viti con impronta a croce Phillips®	1262	T208
	● PH0x60 - PH1x80 - PH2x100 mm		
8	chiavi a forchetta 6x7 - 8x9 - 10x11 - 12x13 - 14x15 - 16x17 - 18x19 - 20x22 mm	55	T33
9	chiavi maschio esagonale piegate	96/SC9	T33
	○ 1,5 - 2 - 2,5 - 3 - 4 - 5 - 6 - 8 - 10 mm		
6	chiavi maschio esagonale con impugnatura	96T	T52
	○ 2 - 2,5 - 3 - 4 - 5 - 6 mm		
6	chiavi maschio con impugnatura per viti con impronta Torx®	97TTX	T55
	○ T10 - T15 - T20 - T25 - T27 - T30		

	5904VG/2T	059040191		2400S5-RVG2T (C24S5/R+5904VG/2T)	024002516		2400S6-RVG2T (C24S6/R+5904VG/2T)	024002626
	2400S5-OVG2T (C24S5/O+5904VG/2T)	024002514		2400S6-OVG2T (C24S6/O+5904VG/2T)	024002624			
	2400S5-GVG2T (C24S5/G+5904VG/2T)	024002515		2400S6-GVG2T (C24S6/G+5904VG/2T)	024002625			

Autoriparazione



20,7 kg

N. pezzi/Descrizione

6	cacciaspina Ø 2+8 mm
1	bulino Ø 5 mm
1	scalpelli piatti nervati 200 mm
17	chiavi combinate 6+22 mm
8	chiavi a forchetta 6x7 - 8x9 - 10x11 - 12x13 - 14x15 - 16x17 - 18x19 - 20x22 mm
9	chiavi maschio esagonale piegate Ø 1,5 - 2 - 2,5 - 3 - 4 - 5 - 6 - 8 - 10 mm
11	chiavi maschio esagonale con impugnatura Ø 2+10 mm
13	chiavi maschio piegate per viti con impronta Torx® Ⓞ T6+T50
1	chiave regolabile a rullino 300 mm
13	chiavi a bussola esagonali 1/2" con guida Ø 10+22 mm
1	prolunga - 1/2" 125 mm
1	prolunga - 1/2" 255 mm
1	snodo 1/2"
1	quadro maschio 1/2" con spina scorrevole
1	cricchetto con quadro scorrevole 1/2" Ⓞ
6	chiavi a T con bussola snodata Ⓞ 8 - 10 - 12 - 13 - 17 - 19 mm
1	leva piatta curva con impugnatura 450 mm
2	pinze becchi dritti per anelli elastici, per fori Ⓞ 180 - 225 mm
2	pinze becchi piegati per anelli elastici, per fori Ⓞ 170 - 210 mm
2	pinze becchi dritti per anelli elastici, per alberi ● 175 - 225 mm
2	pinze becchi piegati per anelli elastici, per alberi ● 175 - 220 mm
1	pinze regolabili cerniera chiusa 250 mm
1	pinza autobloccante 240 mm
1	tronchesi a grande effetto taglienti diagonali ⚡ 200 mm

Beta N.

31/B6
32
35
42
55
96N/SC9
96T/SP11
97TX/B13
111
920A/SB13
920/21
920/22
920/25
920/42
920/50
952
965
1032
1034
1036
1038
1048
1057A
1084BM

N. pezzi/Descrizione

1	tronchesi doppia leva taglio frontale ⚡ 200 mm
1	cesoia a lame larghe diritte 250 mm
1	forbici per elettricisti lame diritte
1	pinza universale 180 mm
4	giravite lama piatta ● 3x75 - 4x100 - 5,5x125 - 6,5x150 mm
1	giravite nano lama piatta ● 6,5x30 mm
2	giravite lama piatta con esagono di manovra ● 8x175 - 10x175 mm
3	giravite per viti con impronta a croce Phillips® Ⓞ PH0x100 - PH1x120 - PH2x100 mm
1	giraviti nano Phillips® Ⓞ PH2x30 mm
1	giravite Phillips® con esagono di manovra Ⓞ PH3x175mm
1	giravite lungo Phillips® Ⓞ PH2x400 mm
1	giravite lama parallela ● 6,5x400 mm
1	martello tipo tedesco 500 g
1	mazzuola con battenti in materiale plastico Ø 45 mm
1	chiave regolabile a nastro per filtri olio
1	spessimetro
5	lime a taglio mezzodolce 200 mm
1	seghetto
1	oliatore in metallo a pressione 200 cc

Beta N.

1092V
1112
1128BMX
1150BM
1260
1260N
1260E
1262
1262N
1262E
1262L
1264L
1370
1390
1491
1708/20
1719BMA/S5
1726BM
1751

5904VG/3

059040192

2400S7-R/VG3
(C24S7/R+5904VG/3)

024002736

2400SA7-R/VG3
(C24SA7/R+5904VG/3)

024002739

2400S7-O/VG3
(C24S7/O+5904VG/3)

024002734

2400SA7-O/VG3
(C24SA7/O+5904VG/3)

024002737

2400S7-G/VG3
(C24S7/G+5904VG/3)

024002735

2400SA7-G/VG3
(C24SA7/G+5904VG/3)

024002738

Autoriparazione



25 kg

N. pezzi/Descrizione

- 5 chiavi a bussola maschio esagonale 1/2"
 - 5 - 6 - 8 - 10 - 12 mm
- 1 prolunga - 1/2" 125 mm
- 1 prolunga - 1/2" 255 mm
- 1 snodo 1/2"
- 1 quadro maschio 1/2" con spina scorrevole
- 1 cricchetto reversibile 1/2" ⊕
- 19 chiavi a bussola esagonali 1/2"
 - 10÷24 - 26 - 27 - 30 - 32 mm
- 16 chiavi combinate 6÷21 mm
- 5 chiavi combinate 22 - 24 - 27 - 30 - 32 mm
- 8 chiavi a T con bussola snodata
 - 7 - 8 - 10 - 12 - 13 - 14 - 17 - 19 mm
 - termoformato vuoto
- 1 pinze becchi diritti per anelli elastici, per fori ○ 180 mm
- 1 pinze becchi piegati per anelli elastici, per fori ○ 170 mm
- 1 pinze becchi diritti per anelli elastici, per alberi ● 175 mm
- 1 pinze becchi piegati per anelli elastici, per alberi ● 175 mm
- 7 giravite lama piatta ● 2,5x50 - 3x75 - 3,5x100 - 4x125 - 5,5x100 - 5,5x150 - 6,5x150 mm
- 5 chiavi maschio con impugnatura per viti con impronta Torx® ⊕ T25 - T27 - T30 - T40 - T45
- 6 chiavi maschio esagonale con impugnatura ○ 2 - 2,5 - 3 - 4 - 5 - 6 mm
- 12 chiavi a forchetta 6x7 - 8x9 - 10x11 - 12x13 - 14x15 - 16x17 - 18x19 - 20x22 mm
- 9 chiavi maschio esagonale piegate ○ 1,5 - 2 - 2,5 - 3 - 4 - 5 - 6 - 8 - 10 mm

Beta N.	TR
920ME	T80
920/21	T80
920/22	T80
920/25	T80
920/42	T80
920/55	T80
920A	T80
VP6	VP6
1032	T145
1034	T145
1036	T145
1038	T145
1290	T170
1297TX	T176
96T	T52
55	T33
96N/SC9	T33

N. pezzi/Descrizione

- 3 giravite lama piatta ● 8x150 - 8x200 - 10x200 mm
- 2 giravite nano lama piatta ● 4x30 - 6,5x30 mm
- 6 giravite Phillips® ⊕ PH0x60 - PH0x100 - PH1x80 - PH1x120 - PH2x100 - PH2x150 mm
- 2 giravite Phillips® ⊕ PH3x150 - PH4x200 mm
- 2 giravite nano Phillips® ⊕ PH1x30 - PH2x30 mm
- 2 scalpelli piatti nervati 100 - 200 mm
- 1 martello tipo tedesco 300 g
- 1 mazzuola con battenti in materiale plastico Ø 35 mm
- 1 pinza universale 180 mm
- 1 pinza a becchi mezzotondi diritti ● 160 mm
- 1 tronchesi a grande effetto taglienti diagonali ✂ 160 mm
- 8 inserti per avvitatori per viti con impronta Torx® ⊕ T6+T15
- 8 inserti per avvitatori per viti con impronta Torx® ⊕ T20+T55
- 1 bussola portainseri
- 1 bussola portainseri
- 1 chiavi a bussola 1/4" per viti con teste a profilo Torx® ⊕ E4÷E10
- 1 chiavi a bussola 1/2" per viti con teste a profilo Torx® ⊕ E12÷E24
- 1 chiavi a bussola maschio per viti con impronta Torx® 1/2" ⊕ T55L - T60 - T70L
- 1 pinze regolabili cerniera chiusa 250 mm
- 1 pinza autobloccante 240 mm

Beta N.	TR
1290	T171
1290N	T171
1292	T172
1292	T173
1292N	T173
35	T234
1370	T234
1390	T234
1150BM	T131
1166BM	T131
1084BM	T131
861TX	T112
866TX	T112
895/1	T112
895/6	T112
900FTX	T112
920FTX	T112
920TX	T112
1048	T153
1052	T153

5904VG/5T

059040196



2400S8-GVG5T
(C24S8/G+5904VG/5T)

024002825



2400S8-OVG5T
(C24S8/O+5904VG/5T)

024002824



2400S8-RVG5T
(C24S8/R+5904VG/5T)

024002826

Autoriparazione



20 kg

N. pezzi/Descrizione

1	punzoni Ø 4 mm
6	cacciaspina Ø 2 - 3 - 4 - 5 - 6 - 8 mm
1	bulino Ø 4 mm
1	scalpelli piatti 150 mm
1	ugnetti 150 mm
17	chiavi combinate 6+22 mm
10	chiavi maschio esagonale piegate \odot 1,5+12 mm
1	chiave regolabile a rullino 300 mm
12	chiavi a bussola con impugnatura, tipo lungo \odot 4+14 mm
1	leva piatta curva con impugnatura 450 mm
1	pinze regolabili cerniera chiusa 250 mm
1	pinza autobloccante 240 mm
1	pinza autobloccante ganasce alluminio 280 mm
1	tronchesi a grande effetto taglienti diagonali \sphericalangle 160 mm
1	tenaglia per cementisti 250 mm
1	cesoia a doppia leva dritta
1	forbici per elettricisti lame diritte
1	pinza universale 180 mm
1	giravite Dzus® \bullet
4	giravite lama piatta \bullet 3x75 - 4x100 - 5,5x150 - 6,5x150 mm
1	giravite nano lama piatta \bullet 4x30 mm
2	giravite lama piatta con esagono di manovra \bullet 10x175 - 12x200 mm

Beta N.

30
31/B6
32
34
36
42/S17
96/B10
111N
943BX
965
1048
1052
1060AL
1084BM
1098PL
1122
1128BMX
1150BM
1201DZ
1260
1260N
1260E

N. pezzi/Descrizione

3	giravite per viti con impronta a croce Phillips® \oplus PH0x60 - PH1x80 - PH2x100 mm
1	giraviti nano Phillips® \oplus PH1x30 mm
1	giravite Phillips® con esagono di manovra \oplus PH3x175 mm
7	chiave maschio per viti con impronta Torx® \otimes T6 - T8 - T10 - T15 - T20 - T25 - T30
1	tasso a virgola 1350 g
1	tasso curvo
1	tasso a tacco bombato
1	tasso a rotaia
1	tasso a tampone
1	leva a cazzuola
1	leva a cucchiaino pesante
1	leva a gomito e piana
1	lima e portailima
1	scalpello extrapiatto con paramano
1	martello con testa tonda e penna
1	martello con testa tonda e quadra Ø 32 mm
1	martello tipo tedesco 300 g
1	mazzuola con battenti in materiale plastico Ø 35 mm
1	flessometro 5 m

Beta N.

1262
1262N
1262E
1267TX
1303
1305
1306
1310
1313
1326
1327
1330
1338A
1342PM
1345
1357Z/32
1370
1390
1692

5905 VG/1

059050158

2500/VG1
(C25+5905VG/1)

025000092

Autoriparazione



19,5 kg

N. pezzi/Descrizione

- 6 2 punzoni, 1 bulino, 3 scalpelli con supporto
- 14 chiavi combinate 6+14 - 17 - 19 - 22 - 24 mm
- 13 chiavi a forchetta 6x7 - 8x9 - 10x11 - 12x13 - 14x15 - 16x17
18x19 - 20x22 - 21x23 - 24x26 - 25x28 - 27x29 - 30x32 mm
- 3 chiavi poligonali doppie starter 11x13 - 14x17 - 19x22 mm
- 10 chiavi maschio esagonale piegate \odot 1,5+12 mm
- 6 chiavi maschio con impugnatura per viti con impronta Torx® \odot T10 - T15 - T20 - T25 - T30 - T40
- 2 chiavi a bussola Macchina 1/2" \odot 17 - 19 mm
- 20 chiavi a bussola esagonali 1/2" \odot 10+24 - 26 - 27 - 28 - 30 - 32 mm
- 1 prolunga - 1/2" 125 mm
- 1 prolunga - 1/2" 255 mm
- 1 snodo 1/2"
- 1 quadro maschio 1/2" con spina scorrevole
- 1 cricchetto reversibile 1/2" \odot
- 8 chiavi a T con bussola snodata \odot 7 - 8 - 10 - 11 - 13 - 14 - 17 - 19 mm
- 1 chiavi a T con bussola snodata per candele
- 1 chiave a croce \odot 17x19x22x \blacksquare 1/2"
- 1 pinze becchi dritti per anelli elastici, per fori \odot 180 mm
- 1 pinze becchi piegati per anelli elastici, per fori \odot 170 mm
- 1 pinze becchi dritti per anelli elastici, per alberi \bullet 175 mm

Beta N. N. pezzi/Descrizione

- | | | |
|---|--|--|
| <ul style="list-style-type: none"> 38/B6 42 55 83 96N/B10 97TTX 720 920A 920/21 920/22 920/25 920/42 920/55 952 959 979 1032 1034 1036 | <ul style="list-style-type: none"> 1 pinze becchi piegati per anelli elastici, per alberi \bullet 175 mm 1 pinze regolabili cerniera chiusa 250 mm 1 pinza autobloccante 240 mm 1 tronchese a grande effetto taglienti diagonali ∇ 160 mm 1 cesoia a doppia leva dritta 250 mm 1 forbici per elettricisti lame diritte 1 pinza universale 180 mm 1 pinza a becchi mezzotondi dritti \bullet 160 mm 8 giravite lama piatta \bullet 2,5x50 - 3x75 - 3,5x100 - 4x125
5,5x125 - 6,5x150 - 8x200 - 10x200 mm 2 giravite lama piatta con esagono di manovra \bullet 10x200 - 12x250 mm 1 giravite nano lama piatta \bullet 6,5x30 mm 4 giravite per viti con impronta a croce Phillips® \oplus PH0x60 - PH1x80
PH2x100 - PH3x150 mm 1 martello tipo tedesco 400 g 1 mazzuola con battenti in materiale plastico \varnothing 35 mm 1 chiave regolabile a nastro per filtri olio 1 provatensione 3+48 V | <ul style="list-style-type: none"> Beta N. 1038 1048 1052 1084BM 1122 1128BMX 1150BM 1166BM 1260 1260E 1260N 1262 1370 1390 1491 1498 |
|---|--|--|

5905VG/2

059050144



2500/VG2
(C25+5905VG/2)

025000084

Autoriparazione



N. pezzi/Descrizione

Beta N. TR

N. pezzi/Descrizione

Beta N. TR

16	chiavi combinate 6÷21 mm	42	T15
5	chiavi combinate 22 - 24 - 27 - 30 - 32 mm	42	T16
5	cacciapina Ø 2 - 3 - 4 - 5 - 6 mm	31	T31
1	bulino Ø 4 mm	32	T31
12	chiavi a forchetta 6x7 - 8x9 - 10x11 - 12x13 - 14x15 - 16x17 - 18x19 - 20x22 - 21x23 - 24x26 - 27x29 - 30x32 mm	55	T31
9	chiavi maschio esagonale piegate Ø 1,5 - 2 - 2,5 - 3 - 4 - 5 - 6 - 8 - 10 mm	96N/SC9	T31
5	chiavi a bussola maschio esagonale 1/2" Ø 5 - 6 - 8 - 10 - 12 mm	920ME	T80
1	prolunga - 1/2" 125 mm	920/21	T80
1	prolunga - 1/2" 255 mm	920/22	T80
1	snodo 1/2"	920/25	T80
1	quadro maschio 1/2" con spina scorrevole	920/42	T80
1	cricchetto reversibile 1/2" ®	920/55	T80
19	chiavi a bussola esagonali 1/2" Ø 10÷24 - 26 - 27 - 30 - 32 mm	920A	T80
1	pinze becchi dritti per anelli elastici, per fori Ø 180 mm	1032	T145
1	pinze becchi piegati per anelli elastici, per fori Ø 170 mm	1034	T145
1	pinze becchi dritti per anelli elastici, per alberi Ø 175 mm	1036	T145
1	pinze becchi piegati per anelli elastici, per alberi Ø 175 mm	1038	T145
1	pinze becchi dritti per anelli elastici, per fori Ø 140 mm	1032	T146
1	pinze becchi piegati per anelli elastici, per fori Ø 225 mm	1034	T146
1	pinze becchi dritti per anelli elastici, per alberi Ø 140 mm	1036	T146
1	pinze becchi piegati per anelli elastici, per alberi Ø 225 mm	1038	T146
9	giravite lama piatta ● 3x75 - 3,5x100 - 4x100 - 4x150 - 5,5x100 - 5,5x150 - 6,5x150 - 8x150 - 10x200 mm	1260	T167
2	giravite nano lama piatta ● 4x30 - 6,5x30 mm	1260N	T167
7	giravite per viti con impronta a croce Phillips® ⚙ PH0x60 - PH0x100 - PH1x80 - PH1x120 - PH2x100 - PH2x150 - PH3x150 mm	1262	T168
2	giraviti nano Phillips® ⚙ PH1x30 - PH2x30 mm	1262N	T168
8	chiavi a T con bussola snodata Ø 7 - 8 - 10 - 12 - 13 - 14 - 17 - 19 mm	952	T63
2	giravite lungo Phillips® ⚙ PH1x400 - PH2x400 mm	1262L	T209
3	giravite lungo lama parallela ● 3x300 - 4x400 - 5x400 mm	1264L	T209
6	chiavi maschio con impugnatura per viti con impronta Torx® ⚙ T10-T15-T20-T25-T27-T30	97TTX	T55
14	chiavi a bussola Macchina 1/2" Ø 10-11-12-13-14-15-16-17-18-19-21-22-23-24 mm	720	T110

1	prolunga Macchina con attacchi quadri maschio e femmina 1/2" 125 mm	720/21	T110
5	chiavi a bussola maschio esagonale 1/2" Ø 5L - 6L - 7L - 8L - 10L	920PE	T113
4	chiavi a bussola maschio per viti con impronta Torx® 1/2" ⚙ T40L - T45L - T55L - T70L	920TX	T113
3	chiavi a bussola maschio a profilo XZN® Ø M6L - M8L - M12L	920XZN	T113
5	lime a taglio mezzodolce 200 mm	1719BMA8/S5	T236
1	chiave regolabile a nastro per filtri olio 110 mm	1491	T264
1	chiave a bussola quadrata per tappi olio motore ■ 10 mm	1494	T264
7	chiavi a bussola maschio esagonale per tappi olio motore Ø 8-9-10-11-12-14-17 mm	1494E	T264
4	chiavi a bussola maschio quadrato per tappi olio motore Ø 8-9-5-12-13 mm	1494Q	T264
1	chiave a bussola maschio triangolare per tappi olio motore Δ	1494T	T264
1	chiave a bussola maschio con profilo XZN® per tappi olio motore Ø	1494XZN	T264
1	chiavi per tappi olio motore	1496/C	T264
2	scalpelli piatti nervati 100 - 200 mm	35	T234
1	martello tipo tedesco 300 g	1370	T234
1	mazzuola con battenti in materiale plastico Ø 35 mm	1390	T234
1	pinze regolabili cerniera chiusa 250 mm	1048	T153
1	pinza autobloccante 240 mm	1052	T153
1	pinza universale = 180 mm	1150	T132
1	pinza a becchi mezzotondi dritti ● 160 mm	1166	T132
1	tronchese a grande effetto taglienti diagonali ⚡ 160 mm	1084	T132
11	chiavi a bussola esagonali 3/4" Ø 22-24-27-30-32-34-36-38-41-46-50 mm	928A	T105
1	prolunga - 3/4" 200 mm	928/21	T106
1	prolunga - 3/4" 380 mm	928/22	T106
1	quadro maschio 3/4" con spina scorrevole 450 mm	928/42	T106
1	cricchetto reversibile 3/4" ®	928/55	T106
1	termoformato vuoto	VP6	VP6
4	chiavi maschio esagonale piegate Ø 13-14-17-19 mm	96N	
1	chiave regolabile a rullino 300 mm	111	
1	leva piatta curva con impugnatura	965	
1	cesoia a lame larghe diritte 250 mm	1112	
1	forbici per elettricisti lame diritte	1128BMX	
1	martello tipo tedesco 1000 g	1370	
1	spessimetro	1708/20	
1	magnete telescopico punta flessibile	1712	
1	specchietto telescopico	1715	
1	raschietto a tre taglienti 200 mm	1717B	
1	seghetto 440 mm	1726	
1	spazzola fili d'ottone	1737	
1	oliatore in metallo a pressione 200 cl	1751	
1	cutter con lama a settori	1771	

5908VG/2T

059080117

2800 GVGZT

(C28 G+5908VG/2T)

028000348

2800 OVGZT
(C28 O+5908VG/2T)

028000347

2800 RVGZT

(C28 R+5908VG/2T)

028000349

Autoriparazione



N. pezzi/Descrizione	Beta N.	TR	N. pezzi/Descrizione	Beta N.	TR
16 chiavi combinate 6÷21 mm	42	T15	1 pinza a becchi mezzotondi diritti 160 mm	1166BM	T131
5 chiavi combinate 22 - 24 - 27 - 30 - 32 mm	42	T16	1 tronchesi a grande effetto taglienti diagonali 160 mm	1084BM	T131
6 chiavi a bussola poligonale snodate doppie 8x9 - 10x11 - 12x13 - 14x15 - 16x17 - 18x19 mm	80	T79	1 pinza regolabile a pulsante 240 mm	1047	T151
1 chiave regolabile a nastro per filtri olio 110 mm	1491	T264	1 pinza autobloccante 240 mm	1057A	T151
1 chiave a bussola quadrata per tappi olio motore 10 mm	1494	T264	8 chiavi a T con bussola snodata	952	T63
7 chiavi a bussola maschio esagonale per tappi olio motore 8-9-10-11-12-14-17 mm	1494E	T264	7 - 8 - 10 - 12 - 13 - 14 - 17 - 19 mm		
4 chiavi a bussola maschio quadrato per tappi olio motore 8-9,5-12-13 mm	1494Q	T264	9 giravite lama piatta 3x75 - 3,5x100 - 4x100 - 4x150 - 5,5x100 - 5,5x150 - 6,5x150 - 8x150 - 10x200 mm	1260	T167
1 chiave a bussola maschio triangolare per tappi olio motore Δ	1494T	T264	2 giravite nano lama piatta 4x30 - 6,5x30 mm	1260N	T167
1 chiave a bussola maschio con profilo XZN® per tappi olio motore ○	1494XZN	T264	1 cacciaspina	31/B6	
1 chiavi per tappi olio motore	1496/C	T264	7 giravite per viti con impronta a croce Phillips® PH0x60 - PH0x100 - PH1x80 - PH1x120 - PH2x100 - PH2x150 - PH3x150 mm	1262	T168
5 chiavi a bussola maschio esagonale 1/2" 5 - 6 - 8 - 10 - 12 mm	920ME	T80	2 giraviti nano Phillips® PH1x30 - PH2x30 mm	1262N	T168
1 prolunga - 1/2" 125 mm	920/21	T80	1 chiave regolabile a rullino 250 mm	111	T59
1 prolunga - 1/2" 255 mm	920/22	T80	1 quadro maschio a T snodato 1/2"	920/40	T59
1 snodo 1/2"	920/25	T80	6 chiavi a T maschio esagonale 2,5-3-4-5-6-8 mm	951	T59
1 quadro maschio 1/2" con spina scorrevole	920/42	T80	4 chiavi a T con maschio esagonale snodato 4-5-6-8 mm	953	T59
1 cricchetto reversibile 1/2" @	920/55	T80	2 martello tipo tedesco 300-500 g	1370	T59
19 chiavi a bussola esagonali 1/2" 10÷24 - 26 - 27 - 30 - 32 mm	920A	T80	2 giravite lungo Phillips® PH1x400 - PH2x400 mm	1262L	T209
1 pinze becchi dritti per anelli elastici, per fori 180 mm	1032	T145	3 giravite lungo lama parallela 3x300 - 4x400 - 5x400 mm	1264L	T209
1 pinze becchi piegati per anelli elastici, per fori 170 mm	1034	T145	1 chiavi maschio esagonale piegate con estremità sferica 96BPC/SC9		
1 pinze becchi dritti per anelli elastici, per alberi 175 mm	1036	T145	1 chiave dinamometrica a scatto 8 ÷ 60 Nm	606/6	
1 pinze becchi piegati per anelli elastici, per alberi 175 mm	1038	T145	1 chiave dinamometrica a scatto 60 ÷ 330 Nm	606/30	
1 pinze becchi dritti per anelli elastici, per fori 140 mm	1032	T146	1 chiavi a bussola Macchina	720/C12	
1 pinze becchi piegati per anelli elastici, per fori 225 mm	1034	T146	1 raccordo quadro maschio 1/2" e femmina 3/8"	910/16	
1 pinze becchi dritti per anelli elastici, per alberi 140 mm	1036	T146	1 assortimento di 12 chiavi a bussola e 5 accessori 3/4"	928A/C12	
1 pinze becchi piegati per anelli elastici, per alberi 225 mm	1038	T146	1 leva con testa snodata piatta curva	966/C3	
6 chiavi maschio con impugnatura per viti con impronta Torx® T10-T15-T20-T25-T27-T30	97TTX	T55	1 mazzuola antirimbalzo Ø 50 mm	1392	
12 chiavi combinate a cricchetto snodate 8 - 9 - 10 - 11 - 12 - 13 - 14 - 15 - 16 - 17 - 18 - 19 mm	142SN	T46	1 avvitatore reversibile in materiale composito 1927P	1927P	
1 pinza universale 180 mm	1150BM	T131			

Motoriparazione



N. pezzi/Descrizione

- 1 punzoni Ø 2 mm
- 1 bulino Ø 4 mm
- 1 scalpelli piatti 125 mm
- 10 chiavi combinate 6 - 7 - 8 - 10 - 11 - 12 - 13 - 14 - 17 - 19 mm
- 6 chiavi a forchetta 6x7 - 8x9 - 10x11 - 12x13 - 14x15 - 16x17 mm
- 9 chiavi maschio esagonale piegate
Ø 1,5 - 2 - 2,5 - 3 - 4 - 5 - 6 - 8 - 10 mm
- 1 chiave dinamometrica a scatto 3/8", 8+60 Nm
- 54 assortimento di 52 inserti con attacco esagonale 10 mm e 2 accessori
- 17 assortimento di 12 chiavi a bussola e 5 accessori
- 1 raccordo quadro maschio 1/2" e femmina 3/8"
- 2 chiavi a bussola per candele 3/8" Ø 16 - 17,8 mm
- 1 pinza a becchi mezzotondi lunghissimi ● 283 mm
- 2 pinze becchi dritti per anelli elastici, per fori Ø 140 - 180 mm

Beta N.

- 30
- 32
- 34
- 42
- 55
- 96/SC9
- 606/6
- 867/C52
- 920A/C12X
- 910/16
- 956E
- 1009L/A
- 1032

N. pezzi/Descrizione

- 1 pinze becchi dritti per anelli elastici, per alberi ● 140x1,3 mm
- 1 tronchesi a taglienti diagonali ≤ 160 mm
- forbici per elettricisti lame dritte
- 1 pinza universale = 180 mm
- 1 giravite Dzus® ●
- 4 giravite lama piatta ● 3x75 - 4x100 - 5,5x100 - 6,5x150 mm
- 3 giravite Phillips® ● PH0x60 - PH1x80 - PH2x100 mm
- 1 giravite provacircuito ●
- 1 martello tipo tedesco 300 g
- chiave regolabile a nastro per filtri olio
- 1 spessimetro
- 1 miniseghetto
- 1 spazzola fili d'ottone
- 1 oliatore in plastica a pressione 250 cc

Beta N.

- 1036
- 1082
- 1128BM
- 1150
- 1201DZ
- 1201
- 1202
- 1254
- 1370
- 1491
- 1708/13
- 1725CR
- 1737
- 1754

5940SBK

059400081

Autoriparazione



24,6 kg

N. pezzi/Descrizione

5	cacciaspina Ø 2 - 3 - 4 - 5 - 6 mm
1	bulino Ø 4 mm
1	scalpelli piatti 150 mm
18	chiavi combinate 6 - 7 - 8 - 9 - 10 - 11 - 12 - 13 - 14 - 17 - 18 - 19 - 21 - 22 - 24 - 27 - 30 mm
12	chiavi a forchetta 6x7 - 8x9 - 10x11 - 12x13 - 14x15 - 16x17 - 18x19 - 20x22 - 21x23 - 24x26 - 27x29 - 30x32 mm
3	chiavi poligonali doppie starter 11x13 - 14x17 - 19x22 mm
12	chiavi maschio esagonale piegate Ø 2÷10 mm
11	chiavi maschio esagonale con impugnatura Ø 2÷8 - 10 mm
20	chiavi a bussola esagonali 1/2" Ø 10÷24 - 26 - 27 - 28 - 30 - 32 mm
5	chiavi a bussola maschio esagonale 1/2" Ø 5 - 6 - 8 - 10 - 12 mm
1	prolunga - 1/2" 125 mm
1	prolunga - 1/2" 255 mm
1	snodo 1/2"
1	quadro maschio 1/2" con spina scorrevole
1	cricchetto reversibile 1/2" Ⓢ
10	chiavi a T con bussola snodata Ø 6 - 7 - 8 - 10 - 11 - 12 - 13 - 14 - 17 - 19 mm
2	chiavi a T con bussola snodata per candele 16 - 20,8 mm
1	chiave a croce Ø 17x19x22x ■ 1/2"
2	pinze becchi dritti per anelli elastici, per fori Ø 140 - 180 mm
1	pinze becchi piegati per anelli elastici, per fori Ø 170 mm
2	pinze becchi dritti per anelli elastici, per alberi ● 140x1,3 - 175 mm
1	pinze becchi piegati per anelli elastici, per alberi ● 175 mm
1	pinze regolabili cerniera chiusa 250 mm

Beta N.

31
32
34
42
55
83
96
96T
920A
920ME
920/21
920/22
920/25
920/42
920/55
952
959
979
1032
1034
1036
1038
1048

N. pezzi/Descrizione

1	pinza autobloccante 240 mm
1	tronchesi a grande effetto taglienti diagonali $\leq 160\text{ mm}$
1	cesoia a lame larghe diritte 250 mm
1	forbici per elettricisti lame diritte
1	pinza universale 180 mm
5	giravite lama piatta ● 3x75 - 4x100 - 5,5x100 - 6,5x150 - 10x200 mm
2	giravite nano lama piatta ● 4x30 - 6,5x30 mm
4	giravite per viti con impronta a croce Phillips® ● PH0x60 - PH1x80 - PH2x100 - PH3x150 mm
2	giraviti nano Phillips® ● PH1x30 - PH2x30 mm
1	giravite lungo Phillips® ● PH2x400 mm
1	giravite lungo lama parallela ● 6,5x400 mm
1	martello tipo tedesco 400 g
1	mazzuola con battenti in materiale plastico Ø 35 mm
1	pinza per anelli elastici SP
1	chiave regolabile a nastro per filtri olio
1	pinza per capicorda non isolati
1	spessimetro
1	flessibile magnetico 0,5 kg
5	lime 200 mm
1	seghetto
1	oliatore in plastica a pressione 250 cc

Beta N.

1052
1084BM
1112
1128BMX
1150BM
1260
1260N
1262
1262N
1262L
1264L
1370
1390
1458
1491
1603
1708/13
1712E/1
1719BMA/S5
1726BM
1754

5953VG



059530085

5300VG
(C53VG+5953VG)

053000025

Autoriparazione



18,9 kg

N. pezzi/Descrizione

5	cacciaspina Ø 2 - 3 - 4 - 5 - 6 mm
1	bulino Ø 4 mm
1	scalpelli piatti 125 mm
18	chiavi combinate 6÷22 - 24 mm
8	chiavi a forchetta 6x7 - 8x9 - 10x11 - 12x13 - 14x15 - 16x17 - 18x19 - 20x22 mm
3	chiavi poligonali curve 12x13 - 14x15 - 17x19 mm
13	chiavi maschio esagonale piegate ○ 2÷10 - 12 mm
3	chiavi a bussola Macchina 1/2" ○ 17 - 19 - 22 mm
1	quadro maschio a T snodato 3/8"
20	chiavi a bussola esagonali 1/2" ○ 10÷24 - 26 - 27 - 28 - 30 - 32 mm
1	prolunga - 1/2" 125 mm
1	prolunga - 1/2" 255 mm
1	snodo 1/2"
1	quadro maschio 1/2" con spina scorrevole
1	cricchetto reversibile 1/2" ⊕
4	chiavi a bussola con impugnatura, tipo lungo ○ 6 - 7 - 8 - 10 mm
10	chiavi a T con bussola snodata ○ 6 - 7 - 8 - 10 - 11 - 12 - 13 - 14 - 17 - 19 mm
3	chiavi a bussola per candele 3/8" ○ 16 - 17,8 - 20,8 mm
1	leva con estremità a punta e a becco
1	pinze becchi dritti per anelli elastici, per fori ○ 180 mm
1	pinze becchi piegati per anelli elastici, per fori ○ 170 mm
1	pinze becchi dritti per anelli elastici, per alberi ● 175 mm
1	pinze becchi piegati per anelli elastici, per alberi ● 175 mm
1	pinze regolabili cerniera chiusa 250 mm

Beta N.

31
32
34
42
55
90
96
720
910/40
920A
920/21
920/22
920/25
920/42
920/55
943BX
952
956E
964
1032
1034
1036
1038
1048

N. pezzi/Descrizione

1	pinza autobloccante 240 mm	1052
1	pinza autobloccante becchi lunghi 180 mm	1058
1	tronchesi a taglienti diagonali 160 mm	1082BM
1	forbici per elettricisti lame diritte	1128BMX
1	pinza universale 180 mm	1150BM
1	pinza a becchi mezzotondi dritti ● 160 mm	1166BM
1	giravite provacircuito ● 6÷24V	1254
6	giravite lama piatta ● 3x75 - 3,5x100 - 4x125 5,5x150 - 6,5x150 - 10x200 mm	1260
1	giravite nano lama piatta ● 6,5x30 mm	1260N
3	giravite per viti con impronta a croce Phillips® ⊕ PH0x60 - PH1x80 - PH2x100 mm	1262
1	giravite nano Phillips® ⊕ PH2x30 mm	1262N
5	chiave maschio per viti con impronta Torx® ⊕ T8 - T10 - T15 - T20 - T25	1267TX
1	martello tipo tedesco 300 g	1370
1	mazzuola antirimbazzo Ø 35 mm	1392
1	pinza molle freni 210 mm	1470
1	pinza per capicorda non isolati	1603
1	flessometro 5 m	1692
1	spessimetro	1708/20
1	flessibile magnetico 1,8 kg	1712E/2
6	lime ad ago 160 mm	1720/B6
1	oliatore in plastica a pressione 150 cc	1754

5954VG

059540085

5400 G/VG
(C54VG G+5954VG)

054000162

5400 O/VG
(C54VG O+5954VG)

054000160

5400 R/VG
(C54VG R+5954VG)

054000164

Autoriparazione



36.6 kg

N. pezzi/Descrizione

6	cacciaspina Ø 2 - 3 - 4 - 5 - 6 - 8 mm
2	punzoni, 1 bulino, 3 scalpelli con supporto
19	chiavi combinate 6÷22 - 24 - 27 mm
12	chiavi poligonali curve 6x7 - 8x9 - 10x11 - 12x13 - 14x15 - 16x17 - 18x19 - 20x22 - 21x23 - 24x27 - 25x28 - 30x32 mm
7	chiavi maschio esagonale piegate Ø 2,5÷10 mm
12	chiavi maschio esagonale piegate Ø 2÷10 mm
13	chiavi maschio piegate per viti con impronta Torx® ⚙ T6÷T50
5	chiavi maschio XZN® piegate M5÷M12
1	chiave regolabile a rullino 250 mm
1	chiave dinamometrica a scatto 1/2", 40÷200 Nm
2	chiavi a bussola Macchina 1/2" Ⓞ 17 - 19 mm
13	chiavi a bussola poligonali 1/2" con guida Ⓞ 10÷22 mm
8	chiavi a bussola poligonali 1/2" con guida Ⓞ 23÷32 mm
4	chiavi a bussola a giravite lama piatta 1/2" Ⓞ 1,2x6,5 - 1,2x8 - 1,6x9 - 2x12 mm
3	chiavi a bussola a giravite lama Phillips® 1/2" ⚙ PH2 - 3 - 4
1	prolunga - 1/2" 125 mm
1	prolunga - 1/2" 255 mm
1	snodo 1/2"
1	quadro maschio snodato 1/2" con impugnatura
1	quadro maschio 1/2" con spina scorrevole
1	cricchetto reversibile 1/2" ⚙
7	chiavi a T con bussola snodata Ⓞ 8 - 10 - 11 - 13 - 14 - 17 - 19 mm
2	chiavi a T con bussola snodata per candele 16 - 20,8 mm
1	leva con estremità a punta e piatta curva
1	pinzetta punte fini curve 120 mm
1	pinzetta punte larghe diritte 150 mm
2	pinze becchi diritti per anelli elastici, per fori Ⓞ 140 - 180 mm
2	pinze becchi piegati per anelli elastici, per fori Ⓞ 130 - 170 mm
2	pinze becchi diritti per anelli elastici, per alberi ● 140x1,3 - 175 mm

Beta N.

31/SP6
38/SP6
42
90/S12X
96N/G7
96/SC12
97TX/B13
98XZN/G
111
606/20
720
920B/SB13
920B/SB8
920LP
920PH
920/21
920/22
920/25
920/35A
920/42
920/55
952
959
963
991
994
1032
1034
1036

N. pezzi/Descrizione

2	pinze becchi piegati per anelli elastici, per alberi ● 135x1,3 - 175 mm
1	pinze regolabili cerniera chiusa 250 mm
1	pinza autobloccante a doppia regolazione
1	tronchesi a grande effetto taglienti diagonali ⚡ 160 mm
1	tronchesi doppia leva taglio frontale ⚡ 180 mm
1	cesoia a lame larghe diritte 250 mm
1	cesoia a lame strette diritte 250 mm
1	forbici per elettricisti lame diritte
1	pinza universale 180 mm
1	pinza a becchi mezzotondi diritti ● 160 mm
1	pinza a becchi mezzotondi piegati ● 200 mm
7	giravite lama piatta ● 3x75 - 3,5x100 - 4x125 - 5,5x150 - 6,5x150 - 10x200 - 12x250 mm
1	giravite lama piatta con esagono di manovra ● 12x200 mm
3	giravite per viti con impronta a croce Phillips® ⚙ PH0x60 - PH1x80 - PH2x100 mm
2	martello tipo tedesco 300 - 600 g
1	mazzuola con battenti in materiale plastico Ø 35 mm
11	estrattori a rulli per viti prigioniere 6÷12 mm
1	chiave regolabile a nastro per filtri olio
1	provatensione
1	flessometro 5 m
1	spessimetro
1	flessibile magnetico 1,8 kg
1	raschietto a due taglienti 200 mm
1	raschietto a tre taglienti 200 mm
5	200 mm
1	seghetto
1	oliatore in metallo a pressione 200 cc
1	cutter con lama a settori

Beta N.

1038
1048
1051
1084BM
1092V
1112
1114
1128BMX
1150BM
1166BM
1168BM
1260
1260E
1262
1370
1390
1433/C11
1491
1498
1692
1708/20
1712E/2
1717A
1717B
1719BMA/S5
1725
1751
1771

5957 VG

059570029

5700 AG/VG

(C57SA/G+5957VG)

057001292

5700 BR/VG

(C57S B/R+5957VG)

057001494

5700 AO/VG

(C57SA/O+5957VG)

057001092

5700 BG/VG

(C57S B/G+5957VG)

057001294

5700 BO/VG

(C57S B/O+5957VG)

057001094

5700 AR/VG

(C57S A/R+5957VG)

057001492

Termoformati morbidi serie MC



Assortimenti di utensili in termoformato per i modelli di cassettiere C22S, C23S, C23SC, C27S

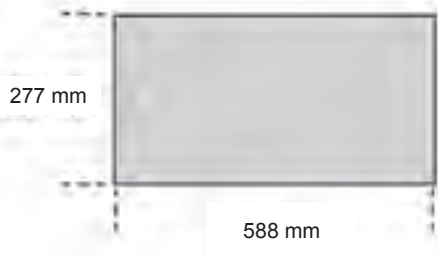
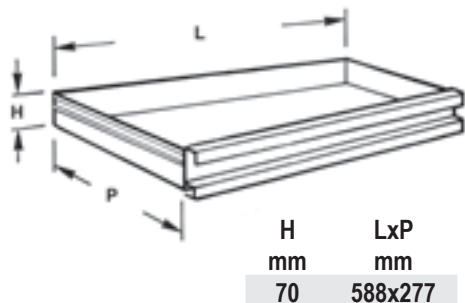

Beta

MC10

34



42	6-7-8-9-10-11-12 13-14-15-16-17 18-19-21-22 mm
96/SC9	1,5-2-2,5-3-4-5-6-8-10 mm
1084BM	160 mm
1150BM	180 mm
1166BM	160 mm
1201	3,5x100-5,5x150-6,5x150 mm
1202	PH0x60-PH1x80-PH2x100 mm

3,5 kg



MC10	1 027500010
MCV10	1 027510010

MC20

74



860MIX/A31	
895/1	
1048	250 mm
1370	300 g
32	Ø 4 mm
36	Ø 4 mm
900	4-4,5-5-5,5-6-7-8-9-10-11-12-13-14 mm
900/21	150 mm
900/25	
900BG/30C	
900/42	
900/55	
920A	10-11-12-13-14-15-16-17-18-19-21-22- 24-27-30-32 mm
920/25	
920AN/125	125 mm
920/42	
920/55	

6 kg



MC20	1 027500020
MCV20	1 027510020

Termoformati morbidi serie M

Assortimenti di utensili in termoformato per tutti i modelli di cassettiere e per i carrelli.

Per maggior chiarezza indichiamo le altezze dei cassetti C1 e C2 alle quali si deve fare riferimento per la scelta del termoformato completo di utensili. A fianco di ogni termoformato è indicato con quale altezza di cassetto è compatibile.

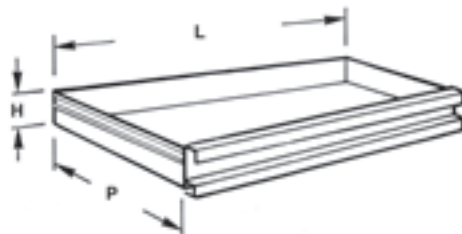

	H mm	LxP mm
C1	50	588x367
C2	70	588x367

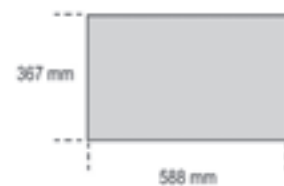
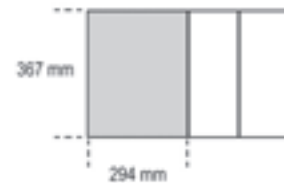
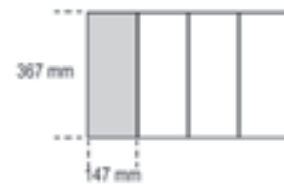

M10

22

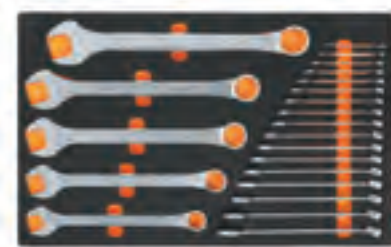

42	6-7-8-9-10-11-12-13-14-15-16-17-18-19- 20-21-22-24-27-30-32-36 mm
----	--

4,5 kg



M10	1 024500010
MV10	1 024510010

M15

16



42 6-7-8-9-10-11-12
13-14-15-16-17
18-19-20-21 mm

1,5 kg

C2



M15	1	024500015
MV15	1	024510015

M16

5



42 22-24-27-30-32 mm

2,1 kg

C2



M16	1	024500016
MV16	1	024510016

M30

31



55 6x7-8x9-10x11-12x13-14x15-16x17-
18x19-20x22-21x23-24x27-30x32 mm
90 6x7-8x9-10x11-12x13-14x15-16x17-
18x19-20x22-21x23-24x27-30x32 mm
96BPC/SC9 1,5-2-2,5-3-4-5-6-8-10 mm

4,2 kg

C2



M30	1	024500030
MV30	1	024510030

M33

17



55 6x7-8x9-10x11
12x13-14x15
16x17-18x19
20x22 mm
96/SC9 1,5+10 mm

1,1 kg

C2



M33	1	024500033
MV33	1	024510033

M38

4



55 21x23-24x26
27x29-30x32 mm

1,7 kg

C1-C2



M38	1	024500038
MV38	1	024510038

M40

7



90 6x7-8x9-10x11
12x13-14x15
16x17-18x19 mm

810 g

C2



M40	1	024500040
MV40	1	024510040

M45

12



142 8-9-10-11-12
13-14-15-16
17-18-19 mm

1,3 kg

C2



M45	1	024500045
MV45	1	024510045

M46

12



142SN 8-9-10-11-12
13-14-15-16
17-18-19 mm

1,4 kg

C2



M46	1	024500046
MV46	1	024510046

M50

8



96T 2-2,5-3-4-5
6-7-8 mm

1,1 kg

C1-C2



M50	1	024500050
MV50	1	024510050

M52

5



96T 2,5-3-4-5-6 mm

330 g

C1-C2



M52	1	024500052
MV52	1	024510052

M53

5



96TBP 2,5-3-4-5-6 mm

350 g

C1-C2



M53	1	024500053
MV52	1	024510052

Beta

M55

5



97TTX T10-T15-T20-T25-T30

330 g



M55	1	024500055
MV55	1	024510055

M60

24

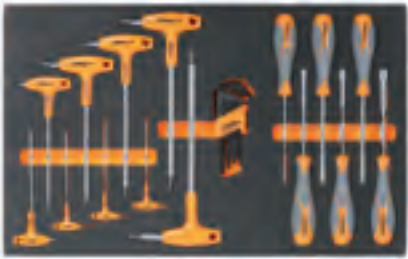

- 96T 2-2,5-3-4-5-6-7-8-10 mm
- 97BTX/SC8 T9-T10-T15-T20-T25-T27-T30-T40
- 944BX 5-6-7-8-10-13 mm

1,9 Kg



M60	1	024500060
MV60	1	024510060

M63

8



952 7-8-10-12-13-14-17-19 mm

3,4 kg



M63	1	024500063
MV63	1	024510063

M65

16

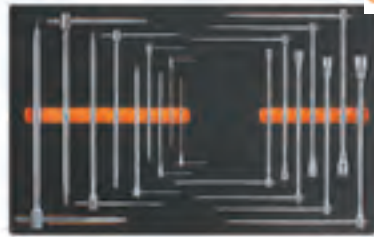

950 8-10-12-13-14-17-19 mm
951 2,5-3-4-5-6-8-10-12-14 mm

3,6 Kg



M65	1	024500065
MV65	1	024510065

M69

9



951 2,5-3-4-5-6-8
10-12-14 mm

1,8 kg



M69	1	024500069
MV69	1	024510069

M75

16



933 7-8-9-10-11-12-13-14-15
16-17-18-19-21-22-24 mm

5,5 kg



M75	1	024500075
MV75	1	024510075

M79

6



80 8x9-10x11-12x13
-14x15 16x17-18x19 mm

1,3 kg



M79	1	024500079
MV79	1	024510079

M82

29



- 920A 10-11-12-13-14
15-16-17-18-19
20-21-22-23-24
26-27-30-32 mm
- 920/ME 5-6-8-10-12 mm
- 920AN/125 125 mm
- 920AN/250 250 mm
- 920/25 305 mm
- 920/42 305 mm
- 920/55

4,1 kg



M82	1	024500082
MV82	1	024510082

M83

24



- 920A 10-11-12-13-14
15-16-17-18-19
20-21-22-23-24
26-27-30-32 mm
- 920AN/125 125 mm
- 920AN/250 250 mm
- 920/25 255 mm
- 920/42 305 mm
- 920/55

3,7 kg



M83	1	024500083
MV83	1	024510083

M85

45



- 851SR 230 mm
- 860LP 0,5x3 - 0,6x4,5
- 0,8x5,5 - 1x5,5 -
1,2x6,5 mm
- 860PE 2 - 2,5 - 3 - 4 - 5 - 6 - 8 -
10 mm
- 860PH PH0 - PH1 - PH2 -
PH3 - PH4
- 860PZ PZ1 - PZ2 - PZ3 - PZ4
- 860TX T6-T7-T8-T9-T10-T15-
T20-T25-T27-T30-T40
- 860RTX T9-T10-T15-T20-T25-
T27-T30-T40
- 860/55 100 mm
- 882P 80 mm

450 g



M85	1	024500085
MV85	1	024510085

 Beta

 Beta

M86

46



- 867PE 4-5-6-7-8-10-12 mm
- 867PE/L 4-5-6-7-8-10-12 mm
- 867XZN 5-6-8-10-12 mm
- 867XZN/L 5-6-8-10-12 mm
- ⊕ 867TX T20-T25-T30-T40-T45-T50-T55
- ⊕ 867TX/L T25-T30-T40-T45-T50-T55
- ⊕ 867RTX T20-T25-T30-T40-T45-T50-T55

867/1
867/2

1,4 kg



C1-C2



M86	1	024500086
MV86	1	024510086

M91

25



- 900 4-4,5-5-5,5-6-7-8-9-10-11-12-13-14 mm
- 900ME 2,5-3-4-5-6-8 mm
- 900/20 50 mm
- 900/21 150 mm
- 900/25 □ 1/4 - ■ 1/4
- 900BG/30
- 900/42
- ⊕ 900/55

560 g

1/4"

C2



M91	1	024500091
MV90	1	024510090

M92

22



- 910A 6-7-8-9-10-11-12-13-14-15-16-17-18-19-20-21-22 mm
- 910/21 125 mm
- 910/22 250 mm
- 910/25
- 910/42
- ⊕ 910/55

1,5 kg

3/8"

C2



M92	1	024500092
MV92	1	024510092

Beta

M100

98



895/1
895/3
895/6

- 900 4-4,5-5,5-6-7-8-9-10-11-12-13-14 mm
- 900L 5-6-7-8-9-10-11-12-13 mm
- 900ME 3-4-5-6-7 mm
- 900LP 0,8x4-1x5,5-1,2x6,5-1,2x8 mm
- ⊕ 900PH PH1-PH2-PH3-PH4
- ⊕ 900TX T10-T15-T20-T25-T27-T30-T40
- 900/20 50 mm
- 900/20L 100 mm
- 900/21 150 mm
- 900/25
- 900BG/30
- 900/42
- ⊕ 900/55

- 920A 8-10-11-12-13-14-15-16-17-18-19-20-21-22-23-24-26-27-28-30-32 mm

920/15
920/25
920AN/125 125 mm
920AN/250 250 mm

- ⊕ 920/55
- ⊕ 920FTX 10-12-14-16-18-20-22-24 mm
- 920AL 10-12-13-14-15-16-17-18-19-21-22 mm

6,7 Kg

C2



M100	1	024500100
MV100	1	024510100

M112

32



- ⊕ 861TX ● 1/4-T6+T15
- ⊕ 866TX ● 5/16-T20+T55
- 895/1 ○ 1/4x□1/4
- 895/6 ○ 5/16x□1/2
- ⊕ 900FTX □ 1/4-E4+E10
- ⊕ 920FTX □ 1/2-E12+E24
- ⊕ 920TX □ 1/2-T55L-T60-T70L

1,3 kg

1/4" 1/2"

C2



M112	1	024500112
MV112	1	024510112

M120

75



- 920A 10-11-12-13-14-15-16-17-18-19-20-21-22-24-26-27-30-32 mm
- 920AN/125 125 mm
- 920AN/250 250 mm
- 920/25
- 920/42
- 920AL 10-12-13-14-15-16-17-18-19-22-24-27-30-32 mm
- ⊕ 920FTX 10-12-14-16-18-20-22-24 mm
- ⊕ 920/55
- 920PE 5-5L-6-6L-7-7L-8-8L-10-10L-12-12L-14-14L
- ⊕ 920TX T20-T25-T27-T30-T40-T45-T50-T55-T60-T20L-T25L-T27L-T30L-T40L-T45L-T50L

6,9 Kg

C2



M120	1	024500120
MV120	1	024510120

M121

46



- 920BP 5L-6L-8L-10L-5XL-6XL-8XL mm
- ⊕ 920TX T20-T25-T27-T30-T40L-T45L-T50L-T55L-T60L-T70L
- 920XZN 4-5-6-6L-8-8L-10-10L-12-12L-14-14L-16-18 mm
- ⊕ 920ES 7-9-10-11-12L-14L-16L-7XL-9XL-10XL-11XL-12XL-14XL-16XL mm
- 920/36A

6,3 Kg

C1-C2



M121	1	024500121
MV121	1	024510121

Beta

Beta

M130

13



- 1032 180 mm
- 1034 170 mm
- 1036 175 mm
- 1038 175 mm
- 1048 250 mm
- 1052 240 mm
- 1082BM 160 mm
- 1098 220 mm
- 1112 250 mm
- 1128BM
- 1150BM 180 mm
- 1166BM 160 mm
- 1168BM 160 mm

3,4 Kg

C1-C2



M130	1	024500130
MV130	1	024510130

M131

3



- 1084BM 160 mm
- 1150BM 180 mm
- 1166BM 160 mm

750 g

C1-C2



M131	1	024500131
MV131	1	024510131

M132

3



- 1084 160 mm
- 1150 180 mm
- 1166 160 mm

650 g

C1-C2



M132	1	024500132
MV132	1	024510132

M135

3



- 1082MQ 160 mm
- 1150MQ 180 mm
- 1166MQ 160 mm

750 g

C1-C2



M135	1	024500135
MV135	1	024510135

M145

4



- 1032 180 mm
- 1034 170 mm
- 1036 175 mm
- 1038 175 mm

640 g

C1-C2



M145	1	024500145
MV145	1	024510145

M153

2



- 1048 250 mm
- 1052 240 mm

1 kg

C1-C2



M153	1	024500153
MV153	1	024510153

M170

7



- 1290 2,5x50
- 3x75
- 3,5x100
- 4x125
- 5,5x100
- 5,5x150
- 6,5x150 mm

500 g

C1-C2



M170	1	024500170
MV170	1	024510170

M172

6



- 1292 PH0x60
- PH0x100
- PH1x80
- PH1x120
- PH2x100
- PH2x150 mm

450 g

C1-C2



M172	1	024500172
MV172	1	024510172

M174

6



- 1297TX T8-T10-T15-T20-T25-T30

450 g

C1-C2



M174	1	024500174
MV174	1	024510174

M180

7



- 1290 3x75
- 4x100
- 5,5x150
- 6,5x150 mm
- 1292 PH0x60
- PH1x80
- PH2x100 mm

500 g

C1-C2



M180	1	024500180
MV180	1	024510180

M199

7



- 1260 2,5x50
- 3x75
- 3,5x100
- 4x125
- 5,5x100
- 5,5x150
- 6,5x150 mm

500 g

C1-C2



M199	1	024500199
MV199	1	024510199

M202



1262

PH0x60
PH0x100
PH1x80
PH1x120
PH2x100
PH2x150 mm

450 g

C1-C2



M202	1	024500202
MV202	1	024510202

M204



1267TX

T8-T10-T15-T20-
T25-T30

450 g

C1-C2



M204	1	024500204
MV204	1	024510204

M208



1260

3x75
3,5x100
4x125
5,5x150
6,5x150 mm

1262

PH0x60
PH1x80
PH2x100 mm

1260N

4x30 mm

1262N

PH1x30 mm

750 g

C1-C2



M208	1	024500208
MV208	1	024510208



M210

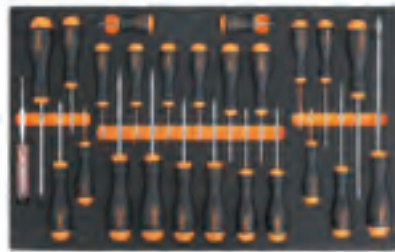

1201

2,5x50-3x75-4x100-5,5x125-6,5x150-
8x200 mm

1201N

4x30 mm

1202

PH0x60-PH1x80-PH2x100-PH3x150 mm

1202N

PH1x30 mm

1207TX

T6-T7-T8-T9-T10-T15-T20-T25-T27-
T30-T40-T45

1253

1,8 Kg

C1-C2



M210	1	024500210
MV210	1	024510210

M211



1201

2,5x50-3x75-3,5x100-
4x125-5,5x100-
5,5x150-6,5x150 mm

500 g

C1-C2



M211	1	024500211
MV211	1	024510211

M212



1202

PH0x60-PH1x80-
PH1x120-PH2x100-
PH2x150-PH3x150
mm

450 g

C1-C2



M212	1	024500212
MV212	1	024510212

M215



1207TX

T6-T7-T8-T9-T10-
T15-T20

500 g

C1-C2



M215	1	024500215
MV215	1	024510215

M220



1201

3x75
4x100
5,5x150
6,5x150 mm

1202

PH0x60
PH1x80
PH2x100 mm

500 g

C1-C2



M220	1	024500220
MV220	1	024510220

M226



1274MQ

3x100
4x100
5,5x125
6,5x150 mm

1272MQ

PH0x60
PH1x80
PH2x100 mm

500 g

C1-C2



M226	1	024500226
MV226	1	024510226

M227



944BX

6-7-8-10-13 mm

420 g

C1-C2



M227	1	024500227
MV227	1	024510227



M230

25

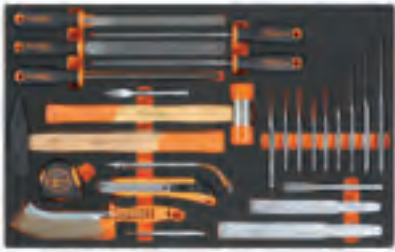

30	Ø 2-3-4 mm
31	Ø 2-3-4-5-6-8 mm
32	Ø 4 mm
34	150 mm
35	200-250 mm
36	125 mm
1370	500 g
1390	Ø 35 mm
1692	3 m
1712TF	
■ 1719BMA/Q	200 mm
▲ 1719BMA/T	200 mm
■ 1719BMA/P	200 mm
▶ 1719BMA/M	200 mm
● 1719BMA/R	200 mm
1737NX	
1771	18 mm

1,3 Kg

C1-C2



M230	1	024500230
MV230	1	024510230

M234

4



35	100-200 mm
1370	300 g
1390	Ø 35 mm

1,3 kg

C1-C2



M234	1	024500234
MV232	1	024510232

M236

5



■ 1719BMA/Q	200 mm
▲ 1719BMA/T	200 mm
■ 1719BMA/P	200 mm
▶ 1719BMA/M	200 mm
● 1719BMA/R	200 mm

870 g

C1 - C2



M236	1	024500236
MV236	1	024510236

M237

5



35	100-200 mm
1370T	300 mm
1390N	Ø 35 mm

1,3 kg

C1-C2



M237	1	024500237
MV232	1	024510232

M240

7



31BM	Ø 2-3-4-5-6-8 mm
32	Ø 4 mm

850 g

C1-C2



M240	1	024500240
MV240	1	024510240

M264

16



1491	Ø 65+110 mm
■ 1494	■ 10 mm
○ 1494E	○ 8-9-10-11-12-14-17 mm
○ 1494Q	○ 8-9,5-12-13 mm
△ 1494T	△ 9,5
○ 1494XZN	○ 16
1496C	■ 8x ■ 10 mm

2,1 kg

C2



M264	1	024500264
MV264	1	024510264

M285

4



1112	250 mm
1128BM	
1726	440 mm
1728BM	(5)
1753	200 cc

1,5 kg

C2



M285	1	024500285
MV285	1	024510285

M287

9



1128BMX	
1130BMX	
■ 1719BMA/Q	200 mm
■ 1719BMA/P	200 mm
▶ 1719BMA/M	200 mm
● 1719BMA/R	200 mm
1726BM	400 mm
1728BM	(5)
1771BM	170 mm
1778	185 mm

2,4 Kg

C1-C2



M287	1	024500287
MV287	1	024510287

M289

4



1692	5 m
1725CR	
1755	30 cc
1771	

500 g

C2



M289	1	024500289
MV289	1	024510289

 **Beta**

M295

4



1650
1682
1707
1708/20

450 g

C1-C2



M295 1 024500295
MV295 1 024510295

M300

14



1927A
720 12-13-14-15-16-17
18-19-21-22
24-27 mm
720/21

4,7 kg

12"

C2



M300 1 024500300
MV300 1 024510300

M310

14



1927CD
720 12-13-14-15-16-17
18-19-21-22
24-27 mm
720/21

4,0 kg

12"

C2



M310 1 024500310
MV310 1 024510310

VPM3

termoformato morbido
con 4 vaschette portaminuterie



C1-C2



VPM3 1 088870353

VPM0

termoformato morbido
con vaschetta portaminuterie



C1-C2



VPM0 1 088870350

Termoformati rigidi serie T



Assortimenti di utensili in termoformato
per tutti i modelli di cassetiere e per i carrelli.

Per maggior chiarezza indichiamo le altezze dei cassetti
C1 e C2 alle quali si deve fare riferimento per la scelta
del termoformato completo di utensili.
A fianco di ogni termoformato è indicato con quale altezza
di cassetto è compatibile.

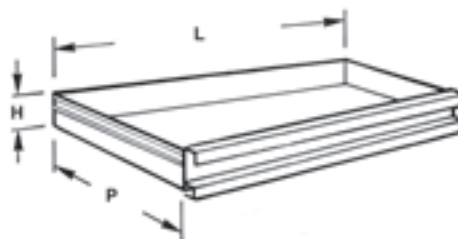

	H mm	LxP mm
C1	50	588x367
C2	70	588x367

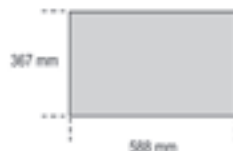
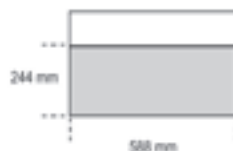
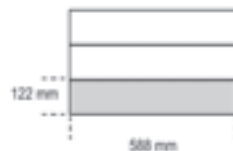
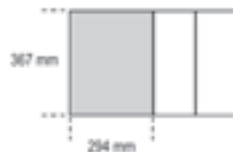

T10

17



42 6-7-8-10-11-12-13
14-16-17-18-19-21
22-24-27-30 mm

2,7 kg

C2



T10 1 024240010
TV10 1 024000400

T15

16



42 6-7-8-9-10-11-12
13-14-15-16-17
18-19-20-21 mm

1,5 kg

C2



T15 1 024240015
TV15 1 024000445

T16

5



42 22-24-27-30-32 mm

2,1 kg

C2



T16 1 024240016
TV16 1 024000446

T18

16



42MP 6-7-8-9-10-11-12
13-14-15-16-17
18-19-20-21 mm

1,5 kg

C2



T18 1 024240018
TV15 1 024000445

T19**5**

42MP 22-24-27-30-32 mm

1 2,1 kg



T19	1	024240019
TV16	1	024000446

T22**15**42AS 5/16-3/8-7/16-1/2
9/16-5/8-11/16-3/4
3/32-1/8-5/32-3/16
1/4-5/16-3/8
○96AS/BG7

1 1 kg



T22	1	024240022
TV20	1	024000488

T23**16**42INOX 8-10-11-12-13-14-15-
17-19 mm
○96BPINOX 2,5-3-4-5-6-8-10 mm

1 1 kg



T23	1	024240023
TV23	1	024249906

T31**27**31 Ø 2-3-4-5-6 mm
32 Ø 4 mm
55 6x7-8x9-10x11
12x13-14x15
16x17-18x19
20x22-21x23
24x26-27x29
30x32 mm
○96N/SC9 1,5+10 mm

1 3 kg



T31	1	024240031
TV30	1	024000401

T33**17**55 6x7-8x9-10x11
12x13-14x15
16x17-18x19
20x22 mm
○96/SC9 1,5+10 mm

1 1 kg



T33	1	024240033
TV20	1	024000488

T34**17**55MP 6x7-8x9-10x11
12x13-14x15
16x17-18x19
20x22 mm
○96/SC9 1,5+10 mm

1 1 kg



T34	1	024240034
TV20	1	024000488

T40**7**90 6x7-8x9-10x11
12x13-14x15
16x17-18x19 mm

1 810 g



T40	1	024240040
TV40	1	024000456

T41**5**90 20x22-21x23
24x26-25x28
27x29 mm

1 1,5 kg



T41	1	024240041
TV41	1	024000457

T45**12**142 8-9-10-11-12
13-14-15-16
17-18-19 mm

1 1,3 kg



T45	1	024240045
TV45	1	024000498

T46**12**142SN 8-9-10-11-12
13-14-15-16
17-18-19 mm

1 1,5 kg



T46	1	024240046
TV46	1	024000499

T48**12**○96BPC/SC9 1,5+10 mm
142C 8-9-10-11-12
13-14-15-16
17-18-19 mm

1 1,4 kg



T48	1	024240048
TV47	1	024000763

T50**11**○96T 2-2,5-3-3,5-4-4,5
5-6-7-8-10 mm

1 1,3 kg



T50	1	024240050
TV50	1	024000764

T52



○96T 2-2,5-3-4-5-6 mm

350 g

C1 - C2



T52	1	024240052
TV52	1	024000765

T53



○96TBP 2,5-3-4-5-6 mm

300 g

C1 - C2



T53	1	024240053
TV52	1	024000765

T55



○97TTX T10-T15-T20
T25-T27-T30

330 g

C1 - C2



T55	1	024240055
TV55	1	024000766

T56



○96BP 2-3-4-5-6-8-10 mm
○97TX T20-T25-T30-T40-
T45-T50-T55

300 g

C1-C2



T56	1	024240056
TV56	1	024249901

T57



○96TINOX 2,5-3-4-5-6 mm

350 g

C1-C2



T57	1	024240057
TV57	1	024249907

T59



111	250 mm
920/40	■ 1/2
951	2,5-3-4-5-6-8 mm
953	4-5-6-8 mm
1370	300 - 500 g

4,7 kg

C2



T59	1	024240059
TV60	1	024000420

T63



○952 7-8-10-12-13-14-17-19 mm

3,8 kg

C1 - C2



T63	1	024240063
TV63	1	024000471



T64



○952FTX E10-E12-E14
○953TX T25-T27-T30-T40-T45

3,8 kg

C1 - C2



T64	1	024240064
TV63	1	024000471

T65



○953 3-3,5-4-5-6-7-8-10 mm

2,8 kg

C1 - C2



T65	1	024240065
TV63	1	024000471

T68



○951 2,5-3-4-5-6-8 mm

590 g

C1 - C2



T68	1	024240068
TV68	1	024000470

T73



○930 6x7-8x9-10x11-12x13-
14x15-16x17-18x19-
20x22 mm

1,3 kg

C2



T73	1	024240073
TV73	1	024000418

T75

16



○ 933 7-8-9-10-11-12-13
14-15-16-17-18-19
21-22-24 mm

4,2 kg

C2

T75 1 024240075
TV75 1 024000422

T76

16



○ 932 7-8-9-10-11-12-13
14-15-16-17-18-19
21-22-24 mm

4,2 kg

C2

T76 1 024240076
TV75 1 024000422

T77

10



○ 933 6-7-8-10-11-12-13
14-17-19 mm

1,4 kg

C2

T77 1 024240077
TV77 1 024000474

T79

6



80 8x9-10x11-12x13
14x15-16x17
18x19 mm

1,3 kg

C2

T79 1 024240079
TV79 1 024000490

T80

29



○ 920A 10-11-12-13-14
15-16-17-18-19
20-21-22-23-24
26-27-30-32 mm
○ 920ME
920/21 125 mm
920/22 255 mm
920/25 305 mm
920/42
⊕ 920/55

4,1 kg

12"

C2

T80 1 024240080
TV80 1 024000403

T81

29



○ 920B 10-11-12-13-14
15-16-17-18-19
20-21-22-23-24
26-27-30-32 mm
○ 920ME
920/21 125 mm
920/22 255 mm
920/25 305 mm
920/42
⊕ 920/55

4,1 kg

12"

C2

T81 1 024240081
TV80 1 024000403

T82

29



○ 920A 10-11-12-13-14
15-16-17-18-19
20-21-22-23-24
26-27-30-32 mm
○ 920ME
920AN/125 125 mm
920AN/250 250 mm
920/25 305 mm
920/42
⊕ 920/55

4,1 kg

12"

C2

T82 1 024240082
TV80 1 024000403

T83

24



○ 920A 10-11-12-13-14
15-16-17-18-19
20-21-22-23-24
26-27-30-32 mm
920/21 125 mm
920/22 255 mm
920/25 305 mm
920/42
⊕ 920/55

3,6 kg

12"

C2

T83 1 024240083
TV83 1 024000402

T85

81



● 861LP 0,5x3 - 0,6x4,5 - 0,8x5,5 - 1x5,5 - 1,2x6,5 - 1,2x8 - 1,6x8 mm
○ 861PE 2 - 2,5 - 3 - 4 - 5 - 6 - 8 - 10 mm
⊕ 861PH PH0 - PH1 - PH2 - PH3
⊕ 861PZ PZ1 - PZ2 - PZ3
⊕ 861TX T6-T7-T8-T9-T10-T15-T20-T25-T27-T30-T40
⊕ 861RTX T9-T10-T15-T20-T25-T27-T30-T40
● 861TRW 1-2-3-4-5-6 mm
⊕ 861TQS 0-1-2-3-4-5-6-8 mm
● 861SP 4-6-8-10-12 mm
851SR 230 mm
○ 900 4-4,5-5-5,5-6-7-8-9
10-11-12-13-14 mm
900/21 150 mm
900/25 41 mm
900BG/30 176 mm
900/42 115 mm
⊕ 900/55 125 mm
194 1/4x5/16

1,0 kg

1/4"

C1 - C2

T85 1 024240085
TV85 1 024000747

T91

25



○ 900 4-4,5-5-5,5-6
7-8-9-10-11
12-13-14 mm
○ 900ME
900/20 50 mm
900/21 150 mm
900/25
900BG/30
900/42 115 mm
⊕ 900/55

560 g

1/4"

C1 - C2

T91 1 024240091
TV90 1 024000447

T92

22



○ 910A 6-7-8-9-10-11-12-13
14-15-16-17-18-19
20-21-22 mm
910/21 125 mm
910/22 250 mm
910/25
910/42 210 mm
⊕ 910/55

1,5 kg

3/8"

C2

T92 1 024240092
TV92 1 024000458

T100

16



- 920A 10-12-13-14-15
16-17-18-19-21
22-24 mm
- 920/21 125 mm
- 920/25
- 920/42 305 mm
- ⊗ 920/55

2,1 kg

12"

C2



T100	1	024240100
TV100	1	024000495

T101

16



- 920B 10-12-13-14-15
16-17-18-19-21
22-24 mm
- 920/21 125 mm
- 920/25
- 920/42 305 mm
- ⊗ 920/55

2,1 kg

12"

C2



T101	1	024240101
TV100	1	024000495

T102

16



- 920AS 3/8-7/16-1/2
9/16-5/8-11/16
3/4-13/16-7/8
15/16-1-1-1/16
- 920/21 125 mm
- 920/25
- 920/42 305 mm
- ⊗ 920/55

2,1 kg

12"

C2



T102	1	024240102
TV100	1	024000495

T103

17



- 900L 6-7-8-9-10-11-12 mm
- 920AL 13-14-16-17-18-19
21-22-24-27 mm

1,1 kg

14" 12"

C1 - C2



T103	1	024240103
TV103	1	024000748

T105

11



- 928A 22-24-27-30-32-34
36-38-41-46-50 mm

4,9 kg

3/4"

C2



T105	1	024240105
TV105	1	024000484

T106

4



- 928/21 200 mm
- 928/22 380 mm
- 928/42 450 mm
- 928/55

4,5 kg

3/4"

C2



T106	1	024240106
TV106	1	024000485

T110

14



- 720 10-11-12-13-14
16-17-18-19-21
22-23-24 mm
- 720/21 125 mm

1,8 kg

12"

C2



T110	1	024240110
TV110	1	024000477

T112

32



- ⊗ 861TX ● 1/4-T6+T15
- ⊗ 866TX ● 5/16-T20+T55
- 895/1 ○ 1/4x□1/4
- 895/6 ○ 5/16x□1/2
- ⊗ 900FTX □ 1/4-E4+E10
- ⊗ 920FTX □ 1/2-E12+E24
- ⊗ 920TX □ 1/2-T55L-T60-T70L

1,3 kg

14" 12"

C2



T112	1	024240112
TV112	1	024000480

T113

12



- 920PE 5L-6L-7L-8L-10L
- ⊗ 920TX T40L-T45L
T55L-T70L
- 920XZN M6L-M8L-M12L

1,5 kg

12"

C2



T113	1	024240113
TV113	1	024000489

T120

1



- 606/20 40-200 Nm

1,1 kg

12"

C2



T120	1	024240120
TV120	1	024000483

T131

3



- ⊗ 1084BM 160 mm
- 1150BM 180 mm
- 1166BM 160 mm

750 g

C1 - C2



T131	1	024240131
TV130	1	024000451

T132

3



- ⊗ 1084 160 mm
- 1150 180 mm
- 1166 160 mm

650 g

C1 - C2



T132	1	024240132
TV130	1	024000451

T135



- 1082MQ 160 mm
- 1150MQ 180 mm
- 1166MQ 160 mm

1000 V

750 g

C1 - C2



T135	1	024240135
TV135	1	024000762

T136



- 1048MQ 250 mm
- 1777MQ/U

700 g

C1 - C2



T136	1	024240136
TV136	1	024000438

T140



- 1032 140x0,9 - 180 mm
- 1034 170 mm
- 1036 140x1,3 - 175 mm
- 1038 175 mm
- 1084 160 mm
- 1128BM

1,1 kg

C1 - C2



T140	1	024240140
TV140	1	024000405

T142



- 1048 250 mm
- 1052 240 mm
- 1112 250 mm
- 1150 180 mm

1,8 kg

C1 - C2



T142	1	024240142
TV143	1	024000409

T145



- 1032 180 mm
- 1034 170 mm
- 1036 175 mm
- 1038 175 mm

640 g

C1 - C2



T145	1	024240145
TV145	1	024000448

T146



- 1032 140x0,9 mm
- 1032 225 mm
- 1036 140x1,3 mm
- 1036 225 mm

700 g

C1 - C2



T146	1	024240146
TV146	1	024000449

T151



- 1047 240 mm
- 1057A 240 mm

1,3 kg

C2



T151	1	024240151
TV150	1	024000462

T153



- 1048 250 mm
- 1052 240 mm

1,1 kg

C1 - C2



T153	1	024240153
TV150	1	024000462

T154



- 1082 160 mm
- 1150 180 mm
- 1048 250 mm

1 kg

C1 - C2



T154	1	024240154
TV148	1	024000500

T155



- 1082BM 160 mm
- 1150BM 180 mm
- 1048BM 250 mm

1,1 kg

C1 - C2



T155	1	024240155
TV148	1	024000500

T160



Betamax



- 1290 3x75
- 3x100
- 4x100
- 4x150
- 5,5x100
- 5,5x150
- 6,5x150
- 8x150
- 10x200 mm
- 1290N 4x30
- 6,5x30 mm

1,3 kg

C1 - C2



T160	1	024240160
TV160	1	024000706

T161



Betamax



- 1292 PH0x60
- PH0x100
- PH1x80
- PH1x120
- PH2x100
- PH2x150
- PH3x150 mm
- 1292N PH1x30
- PH2x30 mm

1 kg

C1 - C2



T161	1	024240161
TV161	1	024000707

T164

16



- 952 8-10-13-17-19 mm
- 959 16 mm (5/8") - 20,8 mm (13/16")
- 1260 3x75-4x100-5,5x100-6,5x150-10x200 mm
- 1262 PH0x60-PH1x80-PH2x100-PH3x150 mm

5 kg

C1 - C2

T164	1	024240164
TV61	1	024000721

T167

11



- 1260 3x75-3x100-4x100-4x150-5,5x100-5,5x150-6,5x150-8x150-10x200 mm
- 1260N 4x30-6,5x30 mm

1,3 kg

C1 - C2

T167	1	024240167
TV160	1	024000706

T168

9



- 1262 PH0x60-PH0x100-PH1x80-PH1x120-PH2x100-PH2x150-PH3x150 mm
- 1262N PH1x30-PH2x30 mm

1 kg

C1 - C2

T168	1	024240168
TV161	1	024000707

T170

7



- 1290 2,5x50-3x75-3,5x100-4x125-5,5x100-5,5x150-6,5x150 mm

450 g

C1 - C2

T170	1	024240170
TV170	1	024000741

T171

5



- 1290 8x150-8x200-10x200 mm
- 1290N 4x30-6,5x30 mm

750 g

C1 - C2

T171	1	024240171
TV171	1	024000742

T172

6



- 1292 PH0x60-PH0x100-PH1x80-PH1x120-PH2x100-PH2x150 mm

450 g

C1 - C2

T172	1	024240172
TV172	1	024000743

T173

4



- 1292 PH3x150-PH4x200 mm
- 1292N PH1x30-PH2x30 mm

560 g

C1 - C2

T173	1	024240173
TV173	1	024000744

T175

7



- 1297TX T6-T7-T8-T9-T10-T15-T20

410 g

C1 - C2

T175	1	024240175
TV175	1	024000760

T176

5



- 1297TX T25-T27-T30-T40-T45

640 g

C1 - C2

T176	1	024240176
TV176	1	024000761

T177

8



- 1298RTX T9-T10-T15-T20-T25-T27-T30-T40

680 g

C1 - C2

T177	1	024240177
TV177	1	024000759

T180

7



- 1290 3x75-4x100-5,5x150-6,5x150 mm
- 1292 PH0x60-PH1x80-PH2x100 mm

480 g

C1 - C2

T180	1	024240180
TV180	1	024000701

T183

Betamax

5



- 1292L PH1x400-PH2x400 mm
- 1294L 3x300-4x400-5x400 mm

580 g

C2

T183	1	024240183
TV183	1	024000497

T198

7



- 1260 3x75, 4x100, 5.5x150, 6.5x150 mm
- 1269PZ PZ0 - PZ1 - PZ2

490 g

C1 - C2

T198	1	024240198
TV180	1	024000701

T199

7



- 1260 2.5x50, 3x75, 3.5x100, 4x125, 5.5x100, 5.5x150, 6.5x150 mm

490 g

C1 - C2

T199	1	024240199
TV170	1	024000741

T201

5



- 1260 8x200, 10x150, 10x200 mm
- 1260N 4x30, 6.5x30 mm

680 g

C1 - C2

T201	1	024240201
TV171	1	024000742

T202

6



- 1262 PH0x60, PH0x100, PH1x80, PH1x120, PH2x100, PH2x150 mm

490 g

C1 - C2

T202	1	024240202
TV172	1	024000743

T204

4



- 1262 PH3x150, PH4x200 mm
- 1262N PH1x30, PH2x30 mm

610 g

C1 - C2

T204	1	024240204
TV173	1	024000744

T205

7



- 1267TX T6-T7-T8-T9, T10-T15-T20

460 g

C1 - C2

T205	1	024240205
TV175	1	024000760

T206

5



- 1267TX T25-T27-T30, T40-T45

710 g

C1 - C2

T206	1	024240206
TV176	1	024000761

T207

7



- 1268RTX T9-T10-T15, T20-T25-T27-T30

760 g

C1 - C2

T207	1	024240207
TV207	1	024000758

T208

7



- 1260 3x75, 4x100, 5.5x150, 6.5x150 mm
- 1262 PH0x60, PH1x80, PH2x100 mm

530 g

C1 - C2

T208	1	024240208
TV180	1	024000701

T209

5



- 1262L PH1x400-PH2x400 mm
- 1264L 3x300-4x400-5x400 mm

580 g

C2

T209	1	024240209
TV183	1	024000497

Beta

T210

7



- 1201 2,5x50
3x75
3,5x100
4x125
5,5x100
5,5x150
6,5x150 mm

490 g

C1 - C2



T210	1	024240210
TV170	1	024000741

T212

6



- ⊕ 1202 PH0x60
PH1x80
PH1x120
PH2x100
PH2x150
PH3x150 mm

490 g

C1 - C2



T212	1	024240212
TV212	1	024000440

T215

7



- ⊙ 1207TX T6-T7-T8-T9
T10-T15-T20

410 g

C1 - C2



T215	1	024240215
TV175	1	024000760

T220

7



- 1201 3x75
4x100
5,5x150
6,5x150 mm
- ⊕ 1202 PH0x60
PH1x80
PH2x100 mm

530 g

C1 - C2



T220	1	024240220
TV180	1	024000701

T226

7



- 1274MQ 3x100
4x100
5,5x125
6,5x150 mm
- ⊕ 1272MQ PH0x60
PH1x80
PH2x100 mm

1000 V

460 g

C1 - C2



T226	1	024240226
TV180	1	024000701

T227

6



- ⊙ 944BX 5-6-7-8-10-13 mm

490 g

C1 - C2



T227	1	024240227
TV227	1	024000705

T228

7



- 1290INOX 3x75 - 4x100 -
5,5x150 - 6,5x150 mm
- ⊕ 1292INOX PH0x60 - PH1x80 -
PH2x100 mm



480 g

C1 - C2



T228	1	024240228
TV180	1	024000701

T231

5



- 1370 400 g
- 1390 Ø 35 mm
- ▲ 1719BMA/T 200 mm
- 1719BMA/P 200 mm
- ▶ 1719BMA/M 200 mm

1,7 kg

C2



T231	1	024240231
TV230	1	024000411

T233

4



- 35 100-200 mm
- 1370F 32 mm
- 1390 Ø 35 mm

1,3 kg

C1 - C2



T233	1	024240233
TV232	1	024000452

T234

4



- 35 100-200 mm
- 1370 300 g
- 1390 Ø 35 mm

1,3 kg

C1 - C2



T234	1	024240234
TV232	1	024000452

T236

5



- 1719BMA/Q 200 mm
- ▲ 1719BMA/T 200 mm
- 1719BMA/P 200 mm
- ▶ 1719BMA/M 200 mm
- 1719BMA/R 200 mm

870 g

C1 - C2



T236	1	024240236
TV235	1	024000453

T239

7



- 31BM Ø 2-3-4-5-6-8 mm
- 32 Ø 4 mm

850 g

C1 - C2



T239	1	024240239
TV239	1	024000439

T241



1500N/1
1500N/3
1516/1

4,2 kg

C2

T241	1	024240241
TV241	1	024000414

T250

Automotive



34 150 mm
83/S3 11x13-14x17
19x22 mm
1458 175 mm
1491
1603
1708/13 0,05±1 mm

1430 g

C1 - C2

T250	1	024240250
TV250	1	024000408

T256

Automotive



956E 16 mm (5/8) - 20,8 mm (13/16)
956L 16 mm (5/8) - 20,8 mm (13/16)
959 16 mm (5/8) - 20,8 mm (13/16)
1164 200 mm
1708/20 0,05±1 mm

3,2 kg

C2

T256	1	024240256
TV256	1	024000467

Beta

T259



96BP 2,5-3-4-5
6-8-10 mm
96N 12 mm
860MIX/A31
895/1

950 g

C2

T259	1	024240259
TV263	1	024000492

T264



1491 Ø 65÷110 mm
1494 10 mm
1494E 8-9-10-11-12-14-17 mm
1494Q 8-9,5-12-13 mm
1494T Δ 9,5
1494XZN 16
1496C 8x 10 mm

2,1 kg

C2

T264	1	024240264
TV261	1	024000466

T270



430 M3 - 4 - 5 - 6 - 7 - 8 - 9
10 - 12 - 14 - 16 - 18 - 20
433 M6x0,75 - M8x1 - M10x1,25
M12x1,5 - M14x1,5
M16x1,5 - M18x1,5
440 M3 - 4 - 5 - 6 - 7 - 8 - 9
440A M10 - 12 - 14 - 16 - 18 - 20
441 M6x0,75 - M8x1,0
441A M10x1,25 - M12x1,5
M14x1,5 - M16x1,5
M18x1,5

4,3 kg

C2

T270	1	024240270
TV270	1	024000481

T273



435/1,5 M3+M12
435/3 M5+M21
436/1 □ 2,0÷5,0 mm
(M3+M8)
436/2 □ 4,6÷8 mm
(M5+M12)
444/1 Ø 25,4 mm
444/2 Ø 38,1 mm
1707 W 62÷4x1"

2,1 kg

C2

T273	1	024240273
TV272	1	024000482

T281



1741B 250 mm
1741RV2,9K 2,9x6 mm (100)
1741RV3,2K 3,2x8 mm (100)
1741RV3,8K 3,8x10 mm (100)
1741RV4K 4x12 mm (100)

1,4 kg

C2

T281	1	024240281
TV280	1	024000478

T285



1112 250 mm
1128BM -
1726 400 mm
1728BM (5)
1753 200 cc

1,5 kg

C2

T285	1	024240285
TV285	1	024000487

Beta

Beta

T287

10



1128BMX	
1130BMX	
■ 1719BMA/Q	200 mm
▲ 1719BMA/T	200 mm
■ 1719BMA/P	200 mm
● 1719BMA/M	200 mm
● 1719BMA/R	200 mm
1726BM	400 mm
1728BM	
1771BM	170 mm
1778	185 mm

2,9 Kg

C2

T287	1	024240287
TV286	1	024249904

T289

4



1692	5 m
1725CR	-
1755	30 cc
1771	-

500 g

C2

T289	1	024240289
TV290	1	024000455

T291

3



1479RB/1	
1479RB/2	
1479RB/3	

600 g

C2

T296	1	024240291
TV291	1	024000472

T297

3



1651DGT	
1682	
1691BM	

490 g

C1 - C2

T297	1	024240297
TV296	1	024000749

VP1 - VP2

termoformati portaminuterie in materiale plastico per tutti i modelli di cassettiere: C22S, C23S, C23SC

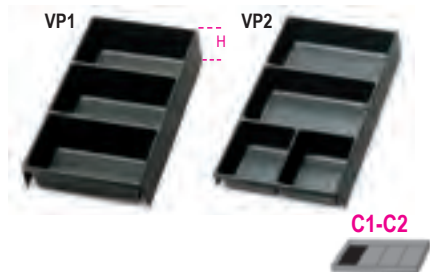

	H		
VP1	mm	1	088880351
VP2	35	1	088880352

VP3 - VP4

termoformati portaminuterie in materiale plastico per tutti i modelli di cassettiere e per i carrelli

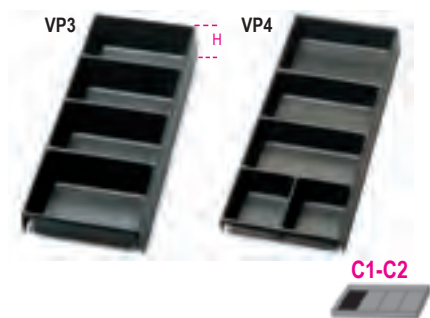

	H		
VP3	mm	1	088880353
VP4	35	1	088880354

VP5

termoformato



VP5	1	088880355
-----	---	-----------

VP6

termoformato



VP6	1	088880359
-----	---	-----------

VP-3SC

termoformati portaminuterie in materiale plastico per cassettiere C38



	H		
VP-3SC	mm	1	088880356
	45		

VP-LS

termoformati portaminuterie in materiale plastico per cassettiere C38



	H		
VP-LS	mm	1	088880357
	45		

VP-LD

termoformati portaminuterie in materiale plastico per cassettiere C38



	H		
VP-LD	mm	1	088880358
	45		

GA/C38-C

guida angolare per C38

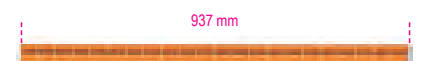

GA/C38-C	5	088880370
----------	---	-----------

GA/C38-SX

guida angolare per C38



GA/C38-SX 5 088880372

GA/C38-DX

guida angolare per C38



GA/C38-DX 5 088880371

SL/C38

separatore longitudinale per C38

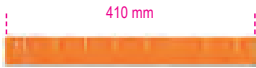

SL/C38 5 088880381

ST/C38-C

separatore trasversale per C38

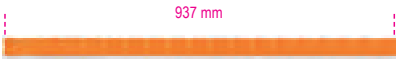

ST/C38-C 5 088880391

ST/C38-SX

separatore trasversale per C38

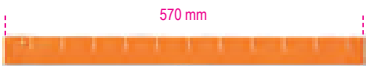

ST/C38-SX 5 088880393

ST/C38-DX

separatore trasversale per C38



ST/C38-DX 5 088880392

GA/C41

guida angolare per C41



GA/C41 5 088880340

SL/C41

separatore longitudinale per C41



SL/C41 5 088880341

ST/C41

separatore trasversale per C41

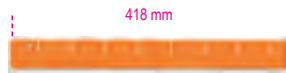

ST/C41 5 088880346

Separatori per cassettiere e per carrelli

	H mm	LxP mm
C1	50	588x367
C2	70	588x367

Separatori per cassettiere:
C22S, C23S, C23SC

	H mm	LxP mm
C3	50	588x257
C4	70	588x257

GA

guida angolare



GA 10 088880300

SL1 - SL2

separatori longitudinali



SL1 10 088880301
SL2 10 088880302

SL3 - SL4

separatori longitudinali



SL3 10 088880303
SL4 10 088880304

ST1 - ST2

separatori trasversali



ST1 10 088880311
ST2 10 088880312

GL1 - GL2

combinazioni di separatori paralleli



GL1 1 088880321
GL2 1 088880322

GL3 - GL4

combinazioni di separatori paralleli



GL3 1 088880323
GL4 1 088880324

TL1 - TL2

combinazioni di separatori incrociati



TL1 1 088880331
TL2 1 088880332

TL3 - TL4

combinazioni di separatori incrociati



TL3 1 088880333
TL4 1 088880334

SB

guide portabussole



SB	L mm		
SB1	210	10	088880201
SB2	280	10	088880202
SB3	360	10	088880203

MB

molle per guide SB



MB			
MB0	1/4	50	088880210
MB1	3/8	50	088880211
MB2	1/2	50	088880212

KIT/GPS



KIT/GPS	50	088880119
---------	----	-----------

VE1



VE1	20	088880120
-----	----	-----------

GM



Ø mm		
6,5	5	088880250
9,5	5	088880251
13	5	088880252
16	5	088880253
19	5	088880254
25	5	088880255

S55/8



S55/8	1	088880400
-------	---	-----------

55-55MP: 6x7-8x9-10x11
12x13-14x15-16x17
18x19-20x22 mm

S55/12



S55/12	1	088880401
--------	---	-----------

55-55MP: 6x7-8x9-10x11
12x13-14x15-16x17
18x19-20x22-21x23
24x26-25x28-30x32 mm

TSPP

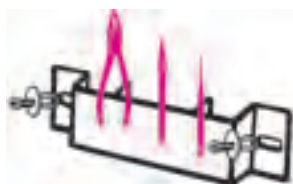

TSPP	1	088880402
------	---	-----------

S952

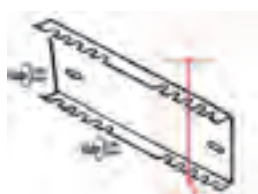

S952	1	088880403
------	---	-----------

952: 6-7-8-10-11
12-13-14-17-19 mm

S1719BM



S1719BM	1	088880404
---------	---	-----------

1719BMA: Q-T-P-M-R
1719BMD: Q-T-P-M-R

SGN



SGN	1	088880405
-----	---	-----------

1290N-1292N-1299N/PZ
1260N-1262N-1269N/PZ
1201N-1202N

CB/2

solo per C54



CB/2	1	088880411
------	---	-----------

920A/920B
10÷24+26-27
28-30-32 mm

S42/18



S42/18	1	088880408
--------	---	-----------

42-42MP: 6÷22+24 mm
42-42MP: 6÷14+16-17
18-19-21-22-24-27-30 mm

S951/6

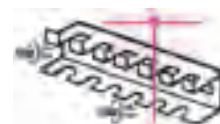

S951/6	1	088880409
--------	---	-----------

951: 2,5-3-4-5-6-8 mm

SP G9 - SP G11



SP G9	1	088880909
-------	---	-----------

n.6 Ø = 7 mm
n.2 Ø = 10 mm
n.1 Ø = 12 mm

SP G11	1	088880910
--------	---	-----------

n.8 Ø = 7 mm
n.2 Ø = 10 mm
n.1 Ø = 12 mm

96T/SPV



96T/SPV	1	000960958
---------	---	-----------

Beta

GAMMA BLISTER

per la tua vendita a libero servizio!

- Efficienza espositiva
- Migliore visibilità
- Codice a barre



SUPPORTO BLISTER:

- PVC Antistrappo
- 4 formati
- Sistema di fissaggio di nuova generazione con fascetta elastica

42K



mm	Handedness	Part No.
6x6	5	000429006
7x7	5	000429007
8x8	5	000429008
9x9	5	000429009
10x10	5	000429010
11x11	5	000429011
12x12	5	000429012
13x13	5	000429013
14x14	5	000429014
15x15	5	000429015
16x16	5	000429016
17x17	5	000429017
18x18	5	000429018
19x19	5	000429019
20x20	3	000429020
21x21	3	000429021
22x22	3	000429022
23x23	3	000429023
24x24	3	000429024
25x25	2	000429025
26x26	2	000429026
27x27	2	000429027
28x28	2	000429028
29x29	2	000429029
30x30	2	000429030
32x32	2	000429032

55K



mm	Handedness	Part No.
6x7	5	000559012
8x9	5	000559021
10x11	5	000559030
12x13	5	000559042
14x15	5	000559054
16x17	5	000559060
18x19	2	000559066
20x22	2	000559075
21x23	2	000559078
24x26	2	000559087
24x27	2	000559090
25x28	2	000559096
27x29	2	000559099
30x32	2	000559108

90K



mm	Handedness	Part No.
6x7	5	000909006
8x9	5	000909012
10x11	5	000909018
12x13	5	000909027
14x15	5	000909033
16x17	5	000909039
18x19	5	000909045
20x22	3	000909051
21x23	2	000909057
24x26	2	000909063
24x27	2	000909067
25x28	2	000909070
30x32	2	000909080

93K



mm	Handedness	Part No.
21x22	3	000939021

94K



mm	Handedness	Part No.
8x10	2	000949008
10x11	2	000949010
11x13	2	000949011
14x17	2	000949015
17x19	2	000949017
19x22	2	000949019
22x24	2	000949022
24x27	2	000949024

96/SC9



Part No.	Handedness	Part No.
96/SC9	1	000960374

1,5-2-2,5-3-4-5-6-8-10 mm

96/ST6K



Part No.	Handedness	Part No.
96/ST6K	3	000969370

2,5-3-4-5-6-8 mm

96N/ST6K



Part No.	Handedness	Part No.
96N/ST6K	3	000969640

2,5-3-4-5-6-8 mm

96BPA/SC9



Part No.	Handedness	Part No.
96BPA/SC9	1	000961974

1,5-2-2,5-3-4-5-6-8-10 mm

96BPC/SC9



Part No.	Handedness	Part No.
96BPC/SC9	1	000960354

1,5-2-2,5-3-4-5-6-8-10 mm

96C/AS



Size	Handedness	Part No.
1/16	20	000961702
3/32	20	000961706
1/8	20	000961710
5/32	20	000961714
3/16	20	000961716
7/32	20	000961718
1/4	20	000961720
5/16	10	000961724
3/8	10	000961728

96LBP/SC9



Part No.	Handedness	Part No.
96LBP/SC9	1	000961354

1,5-2-2,5-3-4-5-6-8-10 mm

96/BGS7



Part No.	Handedness	Part No.
96/BGS7	1	000960367

1,5-2-2,5-3-4-5-6 mm

96/BG7



Part No.	Handedness	Part No.
96/BG7	1	000960368

2,5-3-4-5-6-8-10 mm

96TK



mm	🔧	📦
2	5	000969934
2,5	5	000969935
3	5	000969936
4	5	000969938
5	5	000969940
6	5	000969941
8	3	000969943

97BTX/SC8



97BTX/SC8	🔧	📦
T9-T10-T15-T20-T25-T27-T30-T40	1	000970164

111K



L mm	🔧	📦
150	5	001119015
200	5	001119020
250	5	001119025
300	3	001119030

123/K4



123/K4	🔧	📦
	1	001230504

142K



L mm	🔧	📦
7	3	001429007
8	3	001429008
10	3	001429010
13	3	001429013
17	2	001429017
19	2	001429019
22	1	001429022
24	1	001429024

192/S2



192/S2	🔧	📦
8x10/12x13 16x17/18x19 mm	1	001920070

195K



mm	🔧	📦
8x10	2	001959010
12x13	2	001959013
14x15	2	001959015
16x18	2	001959018
17x19	2	001959019

374K



L mm	🔧	📦
240	1	003749024

850MQ



L mm	🔧	📦
233	1	008500910

855P



L1 mm	🔧	📦
240	1	008550010

860/58K



L mm	🔧	📦
126	1	008609884

860LP



SxA mm	🔧	📦
0,5x3	5	008600005
0,6x4,5	5	008600010
0,8x5,5	5	008600015
1x5,5	5	008600020
1,2x6,5	5	008600025

860PH



PH	🔧	📦
0	5	008600220
1	5	008600225
2	5	008600230
3	5	008600245
4	5	008600250

860PZ



PZ	🔧	📦
1	5	008600320
2	5	008600325
3	5	008600330
4	5	008600335

860PE



mm	🔧	📦
2	5	008600101
2,5	5	008600102
3	5	008600103
4	5	008600104
5	5	008600105
6	5	008600106
8	5	008600108
10	5	008600110

860TX



TX	🔧	📦
T6	5	008600704
T7	5	008600705
T8	5	008600710
T9	5	008600715
T10	5	008600720
T15	5	008600725
T20	5	008600730
T25	5	008600735
T27	5	008600740
T30	5	008600745
T40	5	008600750

860RTX



Size	Quantity	Part Number
T9	5	008600550
T10	5	008600555
T15	5	008600560
T20	5	008600565
T25	5	008600570
T27	5	008600575
T30	5	008600580
T40	5	008600585

860/C27



860/C27 1 008600880

860MIX/A10



860MIX/A10 1 008600900

860TX/A10



860TX/A10 1 008600970

860MIX/A31



860MIX/A31 1 008600902

862F/A7



862F/A7 1 008620950

900K



mm	Quantity	Part Number
4	10	009009040
4,5	10	009009045
5	10	009009050
5,5	10	009009055
6	10	009009060
7	10	009009070
8	10	009009080
9	10	009009090
10	10	009009100
11	10	009009110
12	10	009009120
13	10	009009130
14	10	009009140

900/20LK



L mm 100 5 009009819

900/25K



L mm 41 5 009009830

900BG/30K



L mm 128 5 009009834

900/55K



L mm 125 5 009009870

920AK



mm	Quantity	Part Number
10	10	009209010
11	10	009209011
12	10	009209012
13	10	009209013
14	10	009209014
15	10	009209015
16	10	009209016
17	10	009209017
18	10	009209018
19	10	009209019
20	5	009209020
21	5	009209021
22	5	009209022
23	5	009209023
24	5	009209024
25	5	009209025
26	5	009209026
27	5	009209027
28	5	009209028
29	5	009209029
30	5	009209030
32	5	009209032

920/21K



L mm 125 5 009209822

920/25K



L mm 75 5 009209830

920/55K



L mm 275 3 009209882

935K



mm	5	009359105
6x7	5	009359105
8x9	5	009359111
10x11	5	009359115
12x13	5	009359117
14x15	5	009359126
16x17	5	009359128
18x19	5	009359131
20x22	3	009359138

937K



mm	5	009379006
6x6	5	009379006
7x7	5	009379007
8x8	5	009379008
9x9	5	009379009
10x10	5	009379010
11x11	5	009379011
12x12	5	009379012
13x13	5	009379013
14x14	5	009379014
15x15	5	009379015
16x16	5	009379016
17x17	5	009379017
18x18	5	009379018
19x19	5	009379019
20x20	5	009379020
21x21	3	009379021
22x22	3	009379022

943BXK



mm	5	009439005
5,5	5	009439005
6	5	009439006
7	5	009439007
8	5	009439008
10	3	009439010
13	3	009439013

951K



mm	5	009519525
2,5	5	009519525
3	5	009519530
4	5	009519540
5	5	009519550
6	5	009519560
8	5	009519580

1032K



L mm	5	010329017
180	5	010329017

1034K



L mm	5	010349017
170	5	010349017

1036K



L mm	5	010369017
175	5	010369017

1038K



L mm	5	010389017
175	5	010389017

1044K



L mm	5	010449250
250	5	010449250

1044FK



L mm	5	010449015
250	5	010449015

1046K



L mm	5	010469240
240	5	010469240

1048K



L mm	5	010489250
250	5	010489250

1048VK



L mm	5	010489025
250	5	010489025

1052K



L mm	3	010529019
190	3	010529019
240	3	010529024

1082BMK



L mm	3	010829034
140	3	010829034
160	3	010829036

1084BMK



L mm	3	010849036
160	3	010849036

1096K

L mm 200 5 010969020

1098K

L mm 190 5 010989190
 L mm 220 5 010989220

1098PLK

L mm 220 5 010989320

1112K

L mm 200 2 011129020

1122K

L mm 250 2 011229020

1123K

L mm 250 2 011239020

1124K

L mm 250 2 011249020

1128BAX

L mm 150 5 011280088

1128BCX

L mm 155 5 011280080

1128BMX

L mm 145 5 011280050

1128BSX

L mm 145 5 011280060

1128BTX

L mm 155 5 011280070

1129BMK

L mm 145 5 011299000

1130BMX

L mm 190 1 011300001

1142BMK

L mm 160 3 011429036

1149F

L mm 175 1 011490010

1150BMK

L mm 160 3 011509036
 L mm 180 3 011509038
 L mm 200 3 011509040
 L mm 220 2 011509042

1162BMK



L mm		
160	3	011629036

1164BMK



L mm		
160	3	011649036

1166BMK



L mm		
160	3	011669036

1168BMK



L mm		
160	3	011689036

1201K



SxAxL mm		
0,4x2,5x50	5	012019003
0,5x3x75	5	012019009
0,5x3x100	5	012019012
0,6x3,5x100	5	012019021
0,8x4x100	5	012019030
0,8x4x125	5	012019033
1,0x5,5x100	5	012019039
1,0x5,5x150	5	012019042
1,2x6,5x150	5	012019051
1,2x8x150	3	012019057
1,6x10x200	3	012019066

1201NK



SxAxL mm		
0,8x4x30	3	012019103
1,2x6,5x30	3	012019106

1202K



PHxDxL mm		
0x3x60	5	012029003
1x4,5x80	5	012029009
1x4,5x120	5	012029012
2x6x100	5	012029018
2x6x150	5	012029021
3x8x150	3	012029024

1202NK



PHxDxL mm		
1x4,5x30	3	012029103
2x6x30	3	012029106

1204K



SxDxL mm		
0,4x2,5x60	5	012049003
0,5x3x100	5	012049009
0,8x4x100	5	012049012
1x5x125	5	012049018

1207TXK



T6	5	012079006
T7	5	012079007
T8	5	012079008
T9	5	012079009
T10	5	012079010
T15	5	012079015
T20	5	012079020
T25	5	012079025
T27	5	012079027
T30	5	012079030

1208RTXK



T9	5	012089009
T10	5	012089010
T15	5	012089015
T20	5	012089020
T25	5	012089025
T30	5	012089030

1209PZK



PZ		
0	5	012099000
1	5	012099003
2	5	012099006
3	3	012099009

1253



SxAxL mm		
0,5x3,5x100	5	012530001

1254



SxAxL mm		
0,5x3x44	5	012540001

1260K



SxAxL mm		
0,4x2,5x50	5	012609003
0,4x2,5x75	5	012609006
0,5x3x75	5	012609009
0,5x3x100	5	012609012
0,6x3,5x75	5	012609018
0,6x3,5x100	5	012609021
0,8x4x100	5	012609030
0,8x4x125	5	012609033
0,8x4x150	5	012609036
1x5,5x100	5	012609039
1x5,5x150	5	012609042
1,5x6,5x100	5	012609048
1,2x6,5x150	5	012609051
1,2x8x150	3	012609057
1,2x8x200	3	012609060
1,6x10x200	3	012609066

1260NK



SxAxL mm		
0,8x4x30	5	012609103
1,2x6,5x30	5	012609106

1260EK



SxAxL mm		
1,2x6,5x150	3	012609156
1,2x8x175	3	012609157
1,6x10x200	2	012609159
2x12x250	2	012609162

1262K



PHxDxL mm		
0x3x60	5	012629003
0x3x100	5	012629006
1x4,5x80	5	012629009
1x4,5x120	5	012629012
2x6x100	5	012629018
2x6x150	5	012629021
3x8x150	3	012629024
4x10x200	3	012629027

1262NK



PHxDxL mm		
1x4,5x30	5	012629103
2x6x30	5	012629106

1262EK



PHxDxL mm		
2x6x150	3	012629153
3x8x175	3	012629156
4x10x200	3	012629159

1264K



SxDxL mm		
0,5x2,5x60	5	012649003
0,6x3x75	5	012649006
0,6x3x100	5	012649009
0,8x4x100	5	012649012
0,8x4x125	5	012649015
1x5x125	5	012649018
1x5x150	5	012649021
1,2x6,5x150	5	012649024

1267TXK



T5	5	012679005
T6	5	012679006
T7	5	012679007
T8	5	012679008
T9	5	012679009
T10	5	012679010
T15	5	012679015
T20	5	012679020
T25	5	012679025
T27	5	012679027
T30	5	012679030
T40	2	012679040
T45	2	012679045

1268RTXK



T9	3	012689009
T10	3	012689010
T15	3	012689015
T20	3	012689020
T25	3	012689025
T27	3	012689027
T30	3	012689030
T40	2	012689040

1269PZK



PZ		
0	5	012699000
1	5	012699001
2	5	012699002
3	3	012699003
4	3	012699004

1269N/PZK



PZ		
1	5	012699011
2	5	012699012

1290K



SxAxL mm		
0,4x2,5x50	5	012909003
0,4x2,5x75	5	012909006
0,5x3x75	10	012909009
0,5x3x100	10	012909012
0,6x3,5x75	10	012909018

SxAxL mm		
0,6x3,5x100	10	012909021
0,8x4x100	10	012909030
0,8x4x125	10	012909033
0,8x4x150	10	012909036
1x5,5x100	10	012909039
1x5,5x150	10	012909042
1,2x6,5x100	10	012909048
1,2x6,5x150	10	012909051
1,2x8x150	3	012909057
1,2x8x200	3	012909060
1,6x10x200	3	012909066

1290NK



SxAxL mm		
0,8x4x30	5	012909103
1,2x6,5x30	5	012909106

1292K



PHxDxL mm		
0x3x60	10	012929003
0x3x100	5	012929006
1x4,5x80	10	012929009
1x4,5x120	10	012929012
2x6x100	10	012929018
2x6x150	10	012929021
3x8x150	3	012929024
4x10x200	3	012929027

1292NK



PHxDxL mm		
1x4,5x30	5	012929103
2x6x30	5	012929106

1294K



SxDxL mm		
0,5x2,5x60	5	012949003
0,6x3x75	5	012949006
0,8x4x100	5	012949012
1x5x125	5	012949018

1298RTXK



T9	5	012989009
T10	5	012989010
T15	5	012989015
T20	5	012989020

T25	5	012989025
T27	5	012989027
T30	5	012989030
T40	2	012989040

1299PZK



PZ		
0	5	012999000
1	5	012999003
2	5	012999006

1299N/PZK



PZ		
1	5	012999021
2	5	012999024

1472VW



L mm		
200	1	014720051

1473P



A Max mm		
53	1	014730020

1497RC



1497RC	1	014970351
--------	---	-----------

1603BK



mm ²		
0÷8	2	016039010

1691BM



L m	S mm		
5	25	1	016910205
8	32	1	016910208
10	32	1	016910210

1692



L m	S mm		
2	16	5	016920052
3	16	5	016920053
5	19	5	016920055
8	25	5	016920058

1729CG



L mm		
310	2	017290200

1729DM 450



L mm		
450	4	017290450

1741B



Ø mm	2,4	3,2	4	4,8	5
Alluminio	•	•	•	•	•
Acciaio	•	•	•	•	•
Inox	•	•	•		

1741B	1	017410000
-------	---	-----------

1741U



Ø mm	2,4	3	3,2	4	4,8
Alluminio	•	•	•	•	•
Acciaio	•	•	•	•	•
Inox	•	•	•		

1741U	1	017410450
-------	---	-----------

1762K



Ø mm		
2-2,5-3	2	017629001
3,5-4-4,5		

1771



1771	10	017710000
------	----	-----------

1770BM



L mm	A mm		
140	9	10	017700050

1771BM



L mm	A mm		
170	18	10	017710050

1772R



L mm	A mm		
125	18	5	017720006

1773A



L mm	A mm		
180	25	10	017730000

1777BMT



L mm	L1 mm	A mm		
170	80	19	5	017770050

1777T



L mm	A mm	L1 mm		
160	19	65	5	017770030

1783



L mm			
215	5	017830021	
240	5	017830024	

1820



1820 30	1	018200003
30W		
L = 210mm		
1820 60	1	018200006
60W		
L = 220mm		
1820 80	1	018200008
80W		
L = 260mm		

1822



1822 120	1	018220012
120W		
LxA = 250x125mm		
1822 180	1	018220018
180W		
LxA = 250x125mm		
1822 320	1	018220032
320W		
LxA = 250x140mm		

1834PS



L mm			
150	1	018340310	

1834PM



L mm			
140	1	018340320	

1834PL



L mm			
210	1	018340325	

1834PXL



1834PXL	1	018340330
---------	---	-----------

1836B



1836B	1	018360200
-------	---	-----------

1837N



L mm			
450	1	018370002	

1838COB



1838COB	1	018380010
---------	---	-----------

1838P

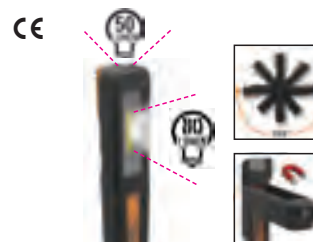

1838P	1	018380005
-------	---	-----------

1847K



L mm			
180	1	018470101	

Beta SHOP in Shop



PROGETTA IL TUO CORNER BETA
www.beta-tools.com/beta/3d/

**SOLUZIONI
ESPOSITIVE
PER IL PUNTO
VENDITA**

38/DS1

espositore da parete
con 75 utensili a percussione



495x260x332 mm

Espositore
con assortimento
38/DS1

1 000380701

n.

30	Ø 2 - 3 - 4 - 5 - 6 mm	5
31	Ø 2 - 3 - 4 - 5 - 6 - 8 - 10 mm	5
32	Ø 3 - 4 - 5 mm	5

Espositore
vuoto
38/DVS1

1 000380751

38/DS2

espositore da parete
con 65 utensili a percussione

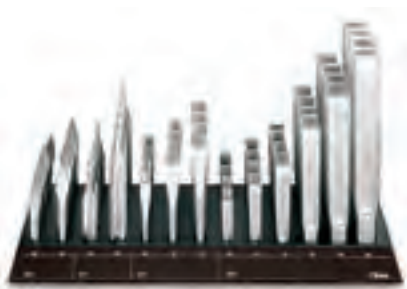

495x260x332 mm

Espositore
con assortimento
38/DS2

1 000380702

n.

34	125 - 150 - 175 mm	5
35	100 - 125 - 150 - 200 - 250 - 300 mm	5
36	125 - 150 mm	5
37	150 - 200 mm	5

Espositore
vuoto
38/DVS2

1 000380752

942BX/DG

espositore da parete
con 43 chiavi a bussola esagonale
con impugnatura tipo corto



330x260x332 mm

Espositore
con assortimento
942BX/DG

1 009420701

n.

942BX	5 - 5,5 mm	3
	6 - 7 mm	6
	8 - 9 - 10 mm	5
	11 mm	2
	12 mm	3
	13 mm	5

Espositore
vuoto
942BX/DVG

1 009420751

943BX/DG

espositore da parete
con 43 chiavi a bussola esagonale
con impugnatura tipo lungo



330x260x332 mm

Espositore
con assortimento
943BX/DG

1 009430701

n.

943BX	5 - 5,5 mm	3
	6 - 7 mm	6
	8 - 9 - 10 mm	5
	11 mm	2
	12 mm	3
	13 mm	5

Espositore
vuoto
943BX/DVG

1 009430751

944BX/DG

espositore da parete
con 43 chiavi a bussola esagonale profonda
con impugnatura tipo lungo



330x260x332 mm

944BX/DG

1 009440701

n.

944BX	5 - 5,5 mm	3
	6 - 7 mm	6
	8 - 9 - 10 mm	5
	11 mm	2
	12 mm	3
	13 mm	5

Espositore
vuoto
944BX/DVG

1 009440751

943MQ/BG

espositore da parete
con 30 chiavi a bussola esagonale
con impugnatura



⚡ 1000 V ⚡

330x260x332 mm

Espositore
con assortimento
943MQ/BG

1 009430281

n.

943MQ	5,5 - 6 - 7 - 8 - 10 - 13 mm	5
-------	------------------------------	---

Espositore
vuoto
943BG-MQ/DV

1 009430285

1203/E1P

espositore da parete
con 82 giravite



495x260x310 mm

Espositore
con assortimento
1203/E1P 1 012030301

n.		
7	1201	0,4x2,5x50 - 0,5x3x75 - 0,6x3,5x100 0,8x4x100 - 0,8x4x125 mm
6		1,0x5,5x100 - 1,0x5,5x150 - 1,2x6,5x150 mm
5		1,2x8x150 mm
7	1202	PH0x3x60 mm
6		PH1x4,5x80 - PH2x6x100 mm
5		PH3x8x150 mm

Espositore
vuoto
1203/EV1P 1 012030351

1203/E4P

espositore da parete
con 85 giravite



495x260x310 mm

Espositore
con assortimento
1203/E4P 1 012030304

n.		
7	1201	0,4x2,5x50 - 0,5x3x75 - 0,8x4x125 mm
6		1,0x5,5x100 - 1,0x5,5x150 - 1,2x6,5x150 mm
7	1204	0,4x2,5x60 - 0,5x3x100 - 0,8x4x100 mm
6		1,0x5x125 mm
7	1209PZ	PZ0x3x60 mm
6		PZ1x4,5x80 - PZ2x6x100 mm

Espositore
vuoto
1203/EV4P 1 012030354

1203/E5P

espositore da parete
con 82 giravite



495x260x310 mm

Espositore
con assortimento
1203/E5P 1 012030305

n.		
7	1202	PH0x3x60 mm
6		PH1x4,5x80 - PH1x4,5x120 PH2x6x100 - PH2x6x150 mm
5		PH3x8x150 mm
7	1204	0,4x2,5x60 - 0,5x3x100 - 0,8x4x100 mm
6		1,0x5x125 mm
7	1209PZ	PZ0x3x60 mm
6		PZ1x4,5x80 - PZ2x6x100 mm

Espositore
vuoto
1203/EV5P 1 012030355

1203/E10P

espositore da parete
con 80 giravite



495x260x310 mm

Espositore
con assortimento
1203/E10P 1 012030310

n.		
4	1207TX	T6
3		T7
7		T8
6		T9 - T10 - T15 - T20 - T25
3		T27 - T30
3	1208RTX	T9 - T10
6		T15 - T20 - T25
3		T27 - T30

Espositore
vuoto
1203/EV10P 1 012030360

1263/E78

Espositore da parete con 78 giravite



Espositore
con assortimento
1263/E78 1 012630510

n.		
7	1260	2,5x75-3x75-3,5x100 mm
7	1262	PH0x60 mm
6		4x100-4x125-5,5x100-5,5x150-6,5x150 mm
4		8x150 mm
6		PH1x80-PH2x100 mm
4		PH3x150

Espositore
vuoto
1263/EV78 1 012630511

1263/E85

espositore da parete
con 85 giravite



495x260x377 mm

Espositore
con assortimento
1263/E85 1 012630550

n.		
7	1260	2,5x50 mm
6		2,5x75 mm
7		3x75 - 3x100 - 3,5x100 mm
6		4x100 - 4x125 - 5,5x125 5,5x150 - 6,5x150 mm
4		8x150 mm
3	1260E	10x200 mm
2		12x250 mm
6	1260N	4x30 - 6,5x30 mm

Espositore
vuoto
1263/EV85 1 012630551

1263/E70

espositore da parete
con 70 giravite



495x260x327 mm

Espositore
con assortimento
1263/E70

1 012630560

		n.	
+	1262	PH0x60 - PH0x100 mm	7
		PH1x80 - PH1x120 mm	6
		PH2x100 mm	9
		PH2x150 - PH3x150 mm	5
		PH4x200 mm	4
+	1262E	PH2x150 mm	5
		PH3x175 mm	4
+	1262N	PH1x30 - PH2x30 mm	6

Espositore
vuoto
1263/EV70

1 012630561

1263/E50

espositore da parete
con 50 giravite



330x260x269 mm

Espositore
con assortimento
1263/E50

1 012630570

		n.	
●	1264	2,5x60 - 3x75 - 3x100 mm	7
		4x100 - 4x125 - 5x125 - 5x150 mm	6
		6,5x150 mm	5

Espositore
vuoto
1263/EV50

1 012630571

1263/E62

espositore da parete
con 62 giravite



495x260x257 mm

Espositore
con assortimento
1263/E62

1 012630590

		n.	
⊕	1267TX	T5	5
		T6	6
		T7	5
		T8	6
		T9	5
		T10 - T15 - T20	6
		T25	5
		T27 - T30	4
		T40 - T45	2

Espositore
vuoto
1263/EV62

1 012630591

1263/E39

espositore da parete
con 39 giravite



330x260x257 mm

Espositore
con assortimento
1263/E39

1 012630595

		n.	
⊕	1268RTX	T9x60 - T10x80 - T15x80 T20x100 - T25x100 mm	6
		T27x115 mm	4
		T30x115 mm	3
		T40x130 mm	2

Espositore
vuoto
1263/EV39

1 012630596

1263/E40

espositore da parete
con 40 giravite



330x260x327 mm

Espositore
con assortimento
1263/E40

1 012630580

		n.	
+	1269	PZ0x60 mm	7
		PZ1x80 mm	6
		PZ2x100 - PZ3x150 - PZ4x200 mm	5
+	1269N	PZ1x30 - PZ2x30 mm	6

Espositore
vuoto
1263/EV40

1 012630581

1273MQ/E1

espositore da parete
con 40 giravite



⚡ 1000 V ⚡

330x260x332 mm

Espositore
con assortimento
1273MQ/E1

1 012730312

		n.	
+	1272MQ	PH0x60 - PH1x80 mm	5
		PH2x100 mm	3
		PH3x150 mm	2
●	1274MQ	3x100 - 4x100 - 5,5x125 - 6,5x150 mm	5
		8x175 mm	3
		10x200 mm	2

Espositore
vuoto
1273BG-MQ/DV

1 012730651

1293BX/DA

espositore da parete
con 90 giravite



495x260x332 mm

Espositore
con assortimento
1293BX/DA 1 012930701

	n.
● 1290 3x75 - 3,5x100 - 4x100 - 4x125 5,5x100 - 5,5x150 mm	7
6,5x150 mm	6
8x150 mm	3
10x200 mm	2
● 1290N 4x30 - 6,5x30 mm	3
⊕ 1292 PH0x60 - PH1x80 mm	7
PH2x100 mm	6
PH3x150 mm	5
⊕ 1292N PH1x30 - PH2x30 mm	3

Espositore
vuoto
1293BX/DVA 1 012930751

1293BX/DD

espositore da parete
con 48 giravite



330x260x332 mm

Espositore
con assortimento
1293BX/DD 1 012930704

	n.
● 1294 2,5x60 - 3x75 - 3x100 - 4x100 4x150 - 5x125 mm	7
6,5x150 mm	6

Espositore
vuoto
1293BX/DVD 1 012930754

1293BX/DE

espositore da parete
con 42 giravite



330x260x332 mm

Espositore
con assortimento
1293BX/DE 1 012930705

	n.
⊕ 1299PZ PZ0x60 - PZ1x80 mm PZ2x100 mm	7
PZ3x150 - PZ4x200 mm	6
⊕ 1299N/PZ PZ1x30 - PZ2x30 mm	5
	6

Espositore
vuoto
1293BX/DVE 1 012930755

1293BX/DF

espositore da parete
con 59 giravite



330x260x332 mm

Espositore
con assortimento
1293BX/DF 1 012930706

	n.
⊕ 1297TX T6 - T8 - T10 - T15 - T20 - T25 T27 - T30	7
T40	6
	5

Espositore
vuoto
1293BX/DVF 1 012930756

C68

parete espositiva vuota Beta



1000x560x2200 mm

C68/1 1 m	1	068000001
C68/2 2 m	1	068000002
C68/3 3 m	1	068000003
C68/4 4 m	1	068000004
C68/5 5 m	1	068000005
C68/6 6 m	1	068000006
C68/7 7 m	1	068000007
C68/8 8 m	1	068000008
C68/9 9 m	1	068000009
C68/10 10 m	1	068000010

C68 G

gondola espositiva vuota



1000x1120x1600 mm

C68 G/1 1 m	1	068000051
C68 G/2 2 m	1	068000052
C68 G/3 3 m	1	068000053
C68 G/4 4 m	1	068000054

C88 R/1

parete espositiva vuota Robur



1000x560x2200 mm

C88 R/1 1 m 1 088000001

C88VE

vasca espositiva per pareti C88 R/1

adatta ad alloggiare bobine di catena art.8120



C88VE 1 088000120

6888

ganci per espositori C60 - C61 - C68 - C88



6888 S1	10	068880011
6888 S2	10	068880012
6888 D1	5	068880021
6888 D2	5	068880022
6888 D4	5	068880024
6888 D5	5	068880025
6888 T1	5	068880031
6888 T2	5	068880032
6888 CT	1	068880044

6800 VE

vetrina per parete espositiva C68 e C68 R/1



6800 VE/1	1 m		1 068000401
6800 VE/2	2 m		1 068000402
6800 VE/3	3 m		1 068000403
6800 VE/4	4 m		1 068000404
6800 VE/5	5 m		1 068000405

ACCESSORI C68



6800 AE		1 068000145
6800 AI		1 068000140
6800 AD/P		1 068000143

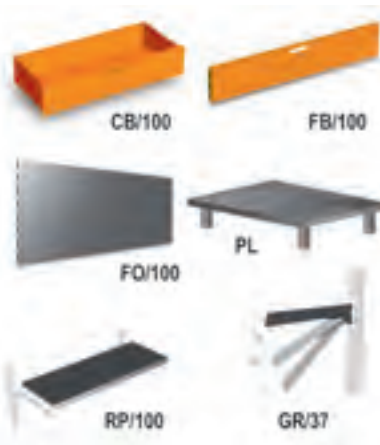

6800 CB/100		1 068000104
6800 FB/100		1 068000109
6800 FO/100		1 068000108
6800 PL		1 068000137
6800 RP/100		1 068000150
6800 GR/37		1 068000159

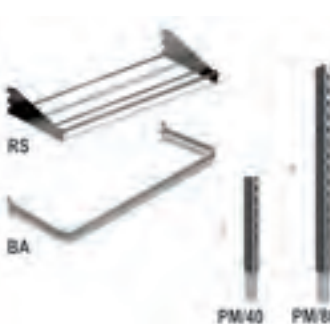

6800 BA		1 068000130
6800 RS		1 068000135
6800 PM/40		1 068000171
6800 PM/80		1 068000172

6600 M/11

assortimento 154 utensili, con ganci senza pannello



6600 M/11 1 066000011

6600 M/22

assortimento 108 utensili, con ganci senza pannello



6600 M/22 1 066000022

6600 M/27

assortimento 25 utensili, con ganci senza pannello



6600 M/27 1 066000027

6600 M/38

assortimento di 107 utensili con ganci senza pannello



6600 M/38 1 066000038

6600 M/39

assortimento 77 utensili,
con ganci senza pannello



6600 M/39  1 066000039

6600 M/40

assortimento 100 utensili,
con ganci senza pannello

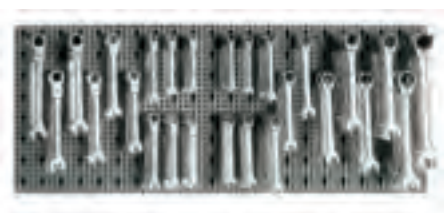

6600 M/40  1 066000040

6600 M/47

assortimento 65 utensili,
con ganci senza pannello



6600 M/47  1 066000047

6600 M/51

assortimento di 257 utensili
con ganci senza pannello



6600 M/51  1 066000051

6600 M/52

assortimento di 176 utensili
con ganci senza pannello



6600 M/52  1 066000052

6600 M/58

assortimento di 150 utensili
con ganci senza pannello



6600 M/58  1 066000058

6600 M/61

assortimento 71 utensili,
con ganci senza pannello



6600 M/61  1 066000061

6600 M/63

assortimento di 110 utensili
con ganci senza pannello



6600 M/63  1 066000063

6600 M/73

assortimento di 68 utensili
con ganci senza pannello



6600 M/73  1 066000073

6600 M/112

assortimento 329 utensili,
con ganci senza pannello



6600 M/112  1 066000112

6600 M/116

assortimento 306 utensili,
con ganci senza pannello



6600 M/116  1 066000116

6600 M/120

assortimento 163 utensili,
con ganci senza pannello



6600 M/120  1 066000120

6600 M/125

assortimento 133 utensili,
con ganci senza pannello

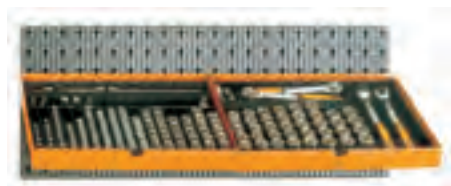

6600 M/125



1 066000125

6600 M/126

assortimento 58 utensili,
con ganci senza pannello



6600 M/126



1 066000126

6600 M/131

assortimento 92 utensili,
con ganci senza pannello



6600 M/131



1 066000131

6600 M/172

assortimento 13 utensili,
con ganci senza pannello



6600 M/172



1 066000172

6600 M/216

assortimento di 80 utensili
con ganci senza pannello



6600 M/216



1 066000216

6600 M/221

assortimento di 83 utensili
con ganci senza pannello



6600 M/221



1 066000221

6600 M/230

assortimento 78 utensili,
con ganci senza pannello



6600 M/230



1 066000230

6600 M/234

assortimento di 31 utensili
con ganci senza pannello



6600 M/234



1 066000234

6600 M/241

assortimento di 43 utensili,
con ganci senza pannello



6600 M/241



1 066000241

6600 M/244

assortimento di 91 utensili
con ganci senza pannello



6600 M/244



1 066000244

6600 M/311

assortimento 114 utensili,
con ganci senza pannello



6600 M/311



1 066000311

6600 M/315

assortimento 149 utensili,
con ganci senza pannello



6600 M/315





1 066000315

6600 M/320

assortimento 98 utensili,
con ganci senza pannello





6600 M/320   1 066000320

6600 M/326

assortimento 155 utensili,
con ganci senza pannello





6600 M/326   1 066000326

6600 M/327

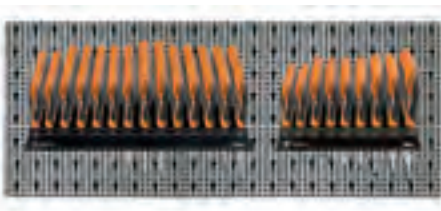
assortimento 101 utensili,
con ganci senza pannello



6600 M/327   1 066000327

6600 M/330

assortimento 110 utensili,
con ganci senza pannello





6600 M/330   1 066000330

6600 M/370

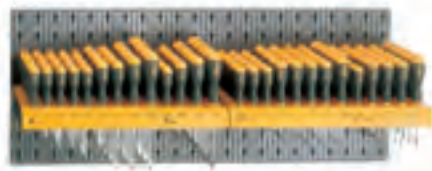
assortimento 162 utensili,
con ganci senza pannello





6600 M/370   1 066000370

6600 M/378

assortimento di 73 utensili
con ganci senza pannello





6600 M/378   1 066000378

6600 M/417

assortimento 43 utensili,
con ganci senza pannello



6600 M/417   1 066000417

6600 M/418

assortimento 35 utensili,
con ganci senza pannello





6600 M/418   1 066000418

6600 M/427

assortimento 24 utensili,
con ganci senza pannello





6600 M/427   1 066000427

6600 M/430

assortimento 29 utensili,
con ganci senza pannello





6600 M/430   1 066000430

6600 M/440

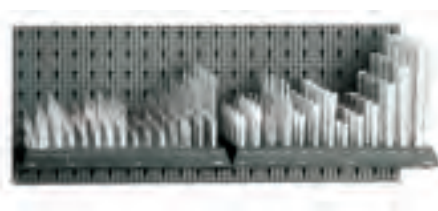
assortimento 140 utensili,
con ganci senza pannello



6600 M/440   1 066000440

6600 M/456

assortimento di 41 utensili,
con ganci senza pannello



6600 M/456   1 066000456

6600 M/464

assortimento 36 utensili,
con ganci senza pannello



6600 M/464



1 066000464

6600 M/480

assortimento 18 utensili,
con ganci senza pannello



6600 M/480



1 066000480

6600 M/485

assortimento 12 utensili,
con ganci senza pannello

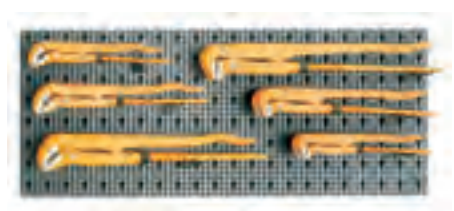

6600 M/485



1 066000485

6600 M/510

assortimento 16 utensili,
con ganci senza pannello



6600 M/510



1 066000510

6600 M/528

assortimento 60 utensili,
con ganci senza pannello



6600 M/528



1 066000528

6600 M/532

assortimento di 24 utensili
con ganci senza pannello



6600 M/532



1 066000532

6600 M/542

assortimento di 53 utensili,
con ganci senza pannello



6600 M/542



1 066000542

6600 M/561

assortimento 60 utensili,
con ganci senza pannello



6600 M/561



1 066000561

6600 M/583

assortimento di 22 utensili
con ganci senza pannello



6600 M/583



1 066000583

6600 M/619

assortimento di 67 utensili,
con ganci senza pannello



6600 M/619



1 066000619

6600 M/637

assortimento di 87 utensili,
con ganci senza pannello



6600 M/637



1 066000637

6600 M/650

assortimento 28 utensili,
con ganci senza pannello



6600 M/650



1 066000650



6600 M/657

assortimento 17 utensili,
con ganci senza pannello



6600 M/657



1 066000657

6600 M/658

assortimento di 14 utensili
con ganci senza pannello



6600 M/658



1 066000658

6600 M/715

assortimento 63 utensili,
con ganci senza pannello



6600 M/715



1 066000715

6600 M/814

assortimento 58 utensili,
con ganci senza pannello



6600 M/814



1 066000814

6600 M/840

assortimento 36 utensili,
con ganci senza pannello



6600 M/840



1 066000840

6600 M/841

assortimento 20 utensili,
con ganci senza pannello



6600 M/841



1 066000841



8600 R/10

assortimento 672 accessori per funi,
con ganci senza pannello



8600 R/10



1 086000010

8600 R/112

assortimento 1942 accessori per funi,
con ganci senza pannello



8600 R/112



1 086000112

8600 R/224

assortimento 61 accessori per funi,
con ganci senza pannello



8600 R/224



1 086000224

8600 R/411

assortimento di 551 accessori INOX per funi
con ganci senza pannello



8600 R/411



1 086000411

8600 E/R

assortimento di 3226 accessori per funi, con ganci senza espositore



8600 E/R

1 086000917

6600 E/A10

assortimento di 605 utensili con ganci senza espositore



6600 E/A10

1 066000912

6600 E/A30

assortimento di 723 utensili con ganci senza espositore



6600 E/A30

1 066000924

6600 E/A20

assortimento di 917 utensili con ganci senza espositore



6600 E/A20

1 066000913

 **Beta**

 **Beta**

6600 E/B10

assortimento di 596 utensili
con ganci senza espositore



6600 E/B10



6600 E/C10

assortimento di 313 utensili
con ganci senza espositore



6600 E/C10



6600 E/B20

assortimento di 601 utensili
con ganci senza espositore

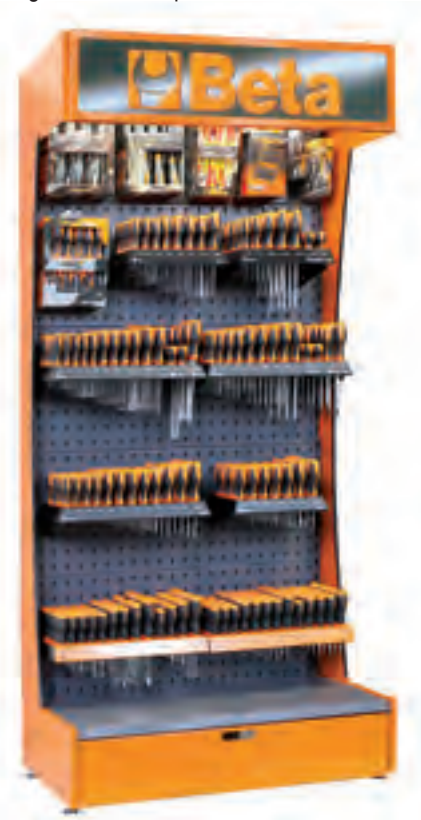

6600 E/B20



6600 E/K20

assortimento di 386 utensili
con ganci senza espositore



6600 E/K20



Beta

CALZATURE DI SICUREZZA

La linea di calzature di sicurezza ha conquistato nel corso degli anni la fiducia e la preferenza dei professionisti più esigenti. Il successo del prodotto ha generato la costante evoluzione e l'ampliamento della gamma di offerta.

NORMATIVE DI SICUREZZA

COME OTTIMIZZARE LA SCELTA DELLE CALZATURE DI SICUREZZA

Assicuratevi che la calzatura corrisponda alla categoria di protezione richiesta, in funzione del tipo e luogo di lavoro.

Di seguito riportiamo le norme Europee di riferimento con le eventuali caratteristiche supplementari.

EN ISO 20344: Metodologia di prova e requisiti generali.

EN ISO 20345: Calzature di sicurezza con puntale resistente a 200 Joule.

EN ISO 20346: Calzature di protezione con puntale resistente a 100 Joule.

EN ISO 20347: Calzature da lavoro, non prevista la presenza di puntale.

EN ISO 20345 Le calzature che rientrano in questa norma

sono contraddistinte dalla lettera "S" (safety = sicurezza)

Per individuare la categoria di protezione la lettera "S" è seguita da lettere e/o numeri.

SB Requisiti minimi:

Puntale con resistenza di 200 Joule.

Tomaia in pelle crosta o similare.

Altezza minima della tomaia.

S1 Caratteristiche SB integrate da:

Antistaticità (A).

Assorbimento d'energia nella zona del tallone (E).

Calzatura chiusa posteriormente. (Anche calzatura bassa)

Antiscivolo UNI EN ISO 20345. Metodo secondo la norma EN 13287

S2 Caratteristiche S1 integrate da:

Impermeabilità della tomaia, resistenza all'acqua per minimo di 1h (WRU).

S3 Caratteristiche S2 integrate da:

Lamina od inserto antiperforazione (P).

Suola scolpita o tassellata.

S4 Caratteristiche S1 integrate da:

Resistenza agli idrocarburi (ORO).

S5 Caratteristiche S4 integrate da:

Lamina od inserto antiperforazione (P).

Suola scolpita o tassellata.

EN ISO 20346 Sono calzature sostanzialmente uguali a quelle di sicurezza, ma avendo il puntale con una resistenza di 100 Joule hanno una marcatura con la lettera "P" (Protective = protezione) e quindi sono riconosciute come Calzature di protezione. Vengono utilizzate ove è sufficiente una protezione di soli 100 Joule.

EN ISO 20347 Sono calzature senza il puntale di protezione, la marcatura avviene con la lettera "O" (Occupational = professionale), quindi sono considerate calzature professionali.

Per facilitare l'identificazione delle caratteristiche tecniche delle calzature che più si addicono alle vostre esigenze vi consigliamo di prendere visione delle icone di seguito rappresentate.



Lamina o inserto antiperforazione.



Puntale in acciaio, in alluminio o in plastica.



Scarpa antistatica.



Assorbimento di energia nella zona del tallone.



Suola resistente ad olii, idrocarburi e solventi.



Suola antiscivolo.



Resistenza alle flessioni ripetute > 60.000.



Suola resistente al calore per contatto (300 °C/min).



Calzatura con ampia calzata per garantire maggiore comfort



Calzatura amagnetica, totalmente priva di componenti metallici



Calzatura sviluppata per assicurare la costante dissipazione delle cariche elettrostatiche dal corpo al suolo



Calzatura sviluppata per garantire l'isolamento dal freddo (CI)

AVVERTENZE

CONTROLLI PRELIMINARI ED UTILIZZO

Prima dell'uso effettuare un controllo visivo dello stato generale della calzatura verificando cuciture, stato della suola e sistemi di chiusura, controllando inoltre che la calzatura abbia tutte

le caratteristiche indicate dall'etichetta, ed in special modo se la calzatura prevede puntale e lamina antiperforazione.

IMPIEGHI SCONSIGLIATI

Sono tassativamente sconsigliati gli impieghi prolungati

e/o ripetuti:

- a contatto con agenti organici, diserbanti, pesticidi ed acidi in forte concentrazione.
- a temperature estreme (oltre -10 °C e + 70 °C).
- di immersione completa in acqua, fango, malte e similari.

SCADENZA

A causa dei numerosi fattori (umidità durante l'immagazzinamento e modificazione della struttura dei materiali nel tempo) non è possibile stabilire con certezza la durata di immagazzinamento della scarpa. In generale, per calzature interamente in poliuretano o con fondo in poliuretano è comunque ipotizzabile una durata massima di tre anni. Per le altre tipologie di calzature è ipotizzabile una durata massima di cinque anni. Tale termine si intende per calzature nuove, imballate e conservate in condizioni controllate, evitando cioè forti escursioni termiche e di umidità relativa

BASIC



7241B

scarpe in pelle con lamina antiperforazione

- Puntale in acciaio
- Lamina antiperforazione in acciaio elastico



EU	UK	
35	2,5	1 072410235
36	3,5	1 072410236
37	4,5	1 072410237
38	5	1 072410238
39	6	1 072410239
40	6,5	1 072410240
41	7	1 072410241
42	8	1 072410242
43	9	1 072410243
44	10	1 072410244
45	10,5	1 072410245
46	11	1 072410246
47	12	1 072410247
48	13	1 072410248

CE



S1P SRC

EN ISO
20345
2011



7241C

scarpe basse in pelle idrorepellente
con lamina antiperforazione

- Puntale in acciaio
- Lamina antiperforazione in acciaio elastico



EU	UK	
35	2,5	1 072410535
36	3,5	1 072410536
37	4,5	1 072410537
38	5	1 072410538
39	6	1 072410539
40	6,5	1 072410540
41	7	1 072410541
42	8	1 072410542
43	9	1 072410543
44	10	1 072410544
45	10,5	1 072410545
46	11	1 072410546
47	12	1 072410547
48	13	1 072410548

CE



S3 SRC

EN ISO
20345
2011



7241FT

scarpe basse in pelle idrorepellente
senza puntale e lamina antiperforazione

- Senza puntale
- Senza lamina antiperforazione



EU	UK	
35	2,5	1 072410635
36	3,5	1 072410636
37	4,5	1 072410637
38	5	1 072410638
39	6	1 072410639
40	6,5	1 072410640
41	7	1 072410641
42	8	1 072410642
43	9	1 072410643
44	10	1 072410644
45	10,5	1 072410645
46	11	1 072410646
47	12	1 072410647
48	13	1 072410648

CE



O2 FO SRC

EN ISO
20347
2012



7243B

scarpe alte in pelle con lamina antiperforazione

- Puntale in acciaio
- Lamina antiperforazione in acciaio elastico

EN ISO
20345
2011



EU	UK	
35	2,5	1 072430235
36	3,5	1 072430236
37	4,5	1 072430237
38	5	1 072430238
39	6	1 072430239
40	6,5	1 072430240
41	7	1 072430241
42	8	1 072430242
43	9	1 072430243
44	10	1 072430244
45	10,5	1 072430245
46	11	1 072430246
47	12	1 072430247
48	13	1 072430248



CE

S1P SRC

7243C

scarpe alte in pelle idrorepellente con lamina antiperforazione e rapido sfilamento

- Puntale in acciaio
- Lamina antiperforazione in acciaio elastico

EN ISO
20345
2011



EU	UK	
35	2,5	1 072430335
36	3,5	1 072430336
37	4,5	1 072430337
38	5	1 072430338
39	6	1 072430339
40	6,5	1 072430340
41	7	1 072430341
42	8	1 072430342
43	9	1 072430343
44	10	1 072430344
45	10,5	1 072430345
46	11	1 072430346
47	12	1 072430347
48	13	1 072430348



CE

S3 RS SRC

7243CR

scarpe alte in pelle idrorepellente con suola in gomma ad alta resistenza e rapido sfilamento

- Puntale in acciaio
- Lamina antiperforazione in acciaio elastico

EN ISO
20345
2011



EU	UK	
35	2,5	1 072430735
36	3,5	1 072430736
37	4,5	1 072430737
38	5	1 072430738
39	6	1 072430739
40	6,5	1 072430740
41	7	1 072430741
42	8	1 072430742
43	9	1 072430743
44	10	1 072430744
45	10,5	1 072430745
46	11	1 072430746
47	12	1 072430747
48	13	1 072430748



CE

S3 RS HRO SRC

7243FT

scarpe alte in pelle idrorepellente senza puntale e lamina antiperforazione

- Senza puntale
- Senza lamina antiperforazione

EN ISO
20347
2012



EU	UK	
35	2,5	1 072430635
36	3,5	1 072430636
37	4,5	1 072430637
38	5	1 072430638
39	6	1 072430639
40	6,5	1 072430640
41	7	1 072430641
42	8	1 072430642
43	9	1 072430643
44	10	1 072430644
45	10,5	1 072430645
46	11	1 072430646
47	12	1 072430647
48	13	1 072430648



CE

O2 FO SRC

7245B

scarpe "saldatore" stringate in pelle idrorepellente con rapido sfilamento e protezione frontale con chiusura a strappo



EU	UK		
35	2,5	1	072450235
36	3,5	1	072450236
37	4,5	1	072450237
38	5	1	072450238
39	6	1	072450239
40	6,5	1	072450240
41	7	1	072450241
42	8	1	072450242
43	9	1	072450243
44	10	1	072450244
45	10,5	1	072450245
46	11	1	072450246
47	12	1	072450247
48	13	1	072450248

- Puntale in acciaio
- Lamina antiperforazione in acciaio elastico



CE

S3 RS SRC

EN ISO
20345
2011



7246B

scarpe in pelle scamosciata, traforate



EU	UK		
35	2,5	1	072460235
36	3,5	1	072460236
37	4,5	1	072460237
38	5	1	072460238
39	6	1	072460239
40	6,5	1	072460240
41	7	1	072460241
42	8	1	072460242
43	9	1	072460243
44	10	1	072460244
45	10,5	1	072460245
46	11	1	072460246
47	12	1	072460247
48	13	1	072460248

- Puntale in acciaio
- Lamina antiperforazione in acciaio elastico



CE

S1P SRC

EN ISO
20345
2011



7247B

sandali in pelle traforata



EU	UK		
35	2,5	1	072470235
36	3,5	1	072470236
37	4,5	1	072470237
38	5	1	072470238
39	6	1	072470239
40	6,5	1	072470240
41	7	1	072470241
42	8	1	072470242
43	9	1	072470243
44	10	1	072470244
45	10,5	1	072470245
46	11	1	072470246
47	12	1	072470247
48	13	1	072470248

- Puntale in acciaio
- Lamina antiperforazione in acciaio elastico



CE

S1P SRC

EN ISO
20345
2011



7328EA

stivali di sicurezza "alta visibilità"



EU	UK		
38	5	1	073280538
39	6	1	073280539
40	6,5	1	073280540
41	7	1	073280541
42	8	1	073280542
43	9	1	073280543
44	10	1	073280544
45	10,5	1	073280545
46	11	1	073280546
47	12	1	073280547

- Puntale in acciaio
- Lamina antiperforazione in acciaio elastico



CE

S5 SRC

EN ISO
20345
2011



7328EN

stivali di sicurezza

- Puntale in acciaio
- Lamina antiperforazione in acciaio elastico

EN ISO
20345
2011



EU	UK	
38	5	1 073280738
39	6	1 073280739
40	6,5	1 073280740
41	7	1 073280741
42	8	1 073280742
43	9	1 073280743
44	10	1 073280744
45	10,5	1 073280745
46	11	1 073280746
47	12	1 073280747

CE



S5 SRC

EASY PLUS



7220PE

scarpe in pelle idrorepellente con inserti in nylon, copripuntale di rinforzo in poliuretano ed inserto rifrangente sul tallone

- Puntale in acciaio
- Lamina antiperforazione in fibra composita

EN ISO
20345
2011



EU	UK	
35	2,5	1 072200135
36	3,5	1 072200136
37	4,5	1 072200137
38	5	1 072200138
39	6	1 072200139
40	6,5	1 072200140
41	7	1 072200141
42	8	1 072200142
43	9	1 072200143
44	10	1 072200144
45	10,5	1 072200145
46	11	1 072200146
47	12	1 072200147
48	13	1 072200148

CE



S3 SRC

7221PE

scarpe alte in pelle idrorepellente con inserti in nylon Rapido sfilamento, copripuntale di rinforzo in poliuretano ed inserto rifrangente sul tallone

- Puntale in acciaio
- Lamina antiperforazione in fibra composita

EN ISO
20345
2011



EU	UK	
35	2,5	1 072210135
36	3,5	1 072210136
37	4,5	1 072210137
38	5	1 072210138
39	6	1 072210139
40	6,5	1 072210140
41	7	1 072210141
42	8	1 072210142
43	9	1 072210143
44	10	1 072210144
45	10,5	1 072210145
46	11	1 072210146
47	12	1 072210147
48	13	1 072210148

CE



S3 RS SRC

7224PE

scarpe in pelle scamosciata traforata con inserti in nylon, copripuntale di rinforzo in poliuretano ed inserto rifrangente sul tallone



- Puntale in acciaio
- Lamina antiperforazione in fibra composita

EU	UK		
35	2,5	1	072240135
36	3,5	1	072240136
37	4,5	1	072240137
38	5	1	072240138
39	6	1	072240139
40	6,5	1	072240140
41	7	1	072240141
42	8	1	072240142
43	9	1	072240143
44	10	1	072240144
45	10,5	1	072240145
46	11	1	072240146
47	12	1	072240147
48	13	1	072240148



EN ISO
20345
2011



CE

S1P SRC

BASIC PLUS



7200BKK

scarpe in pelle pieno fiore idrorepellente



- Puntale in composito
- Lamina antiperforazione in fibra composita

EU	UK		
35	2,5	1	072000235
36	3,5	1	072000236
37	4,5	1	072000237
38	5	1	072000238
39	6	1	072000239
40	6,5	1	072000240
41	7	1	072000241
42	8	1	072000242
43	9	1	072000243
44	10	1	072000244
45	10,5	1	072000245
46	11	1	072000246
47	12	1	072000247
48	13	1	072000248



EN ISO
20345
2011



CE

S3 SRC

7200PN

scarpe in pelle pieno fiore idrorepellente con inserti in pelle scamosciata idrorepellente



- Puntale in composito
- Lamina antiperforazione in fibra composita

EU	UK		
35	2,5	1	072000535
36	3,5	1	072000536
37	4,5	1	072000537
38	5	1	072000538
39	6	1	072000539
40	6,5	1	072000540
41	7	1	072000541
42	8	1	072000542
43	9	1	072000543
44	10	1	072000544
45	10,5	1	072000545
46	11	1	072000546
47	12	1	072000547
48	13	1	072000548



EN ISO
20345
2011



CE

S3 SRC

7201BKK

scarpe alte in pelle pieno fiore idrorepellente

- Puntale in composito
- Lamina antiperforazione in fibra composita

EN ISO
20345
2011



EU	UK		
35	2,5	1	072010435
36	3,5	1	072010436
37	4,5	1	072010437
38	5	1	072010438
39	6	1	072010439
40	6,5	1	072010440
41	7	1	072010441
42	8	1	072010442
43	9	1	072010443
44	10	1	072010444
45	10,5	1	072010445
46	11	1	072010446
47	12	1	072010447
48	13	1	072010448

CE



S3 SRC

7201PN

scarpe alte in pelle pieno fiore idrorepellente con inserti in pelle scamosciata idrorepellente
Rapido sfilamento con doppia clip

- Puntale in composito
- Lamina antiperforazione in fibra composita

EN ISO
20345
2011



EU	UK		
35	2,5	1	072010535
36	3,5	1	072010536
37	4,5	1	072010537
38	5	1	072010538
39	6	1	072010539
40	6,5	1	072010540
41	7	1	072010541
42	8	1	072010542
43	9	1	072010543
44	10	1	072010544
45	10,5	1	072010545
46	11	1	072010546
47	12	1	072010547
48	13	1	072010548

CE



S3 RS SRC

7208WR

scarpe alte in pelle pieno fiore idrorepellente con suola in gomma ad alta resistenza e rapido sfilamento
Calzatura **WR** resistente all'acqua: sottoposta a prova, in una vasca con 3 cm di acqua, dopo 100 lunghezze, l'area totale bagnata all'interno della calzatura non deve superare i 3 cm² (macchia)

- Puntale in composito
- Lamina antiperforazione in fibra composita

EN ISO
20345
2011



EU	UK		
38	5	1	072080238
39	6	1	072080239
40	6,5	1	072080240
41	7	1	072080241
42	8	1	072080242
43	9	1	072080243
44	10	1	072080244
45	10,5	1	072080245
46	11	1	072080246
47	12	1	072080247

CE



S3 RS WR HRO SRC

7210BKK

scarpe in morbida pelle scamosciata traforata

- Puntale in composito
- Lamina antiperforazione in fibra composita

EN ISO
20345
2011



EU	UK		
35	2,5	1	072100335
36	3,5	1	072100336
37	4,5	1	072100337
38	5	1	072100338
39	6	1	072100339
40	6,5	1	072100340
41	7	1	072100341
42	8	1	072100342
43	9	1	072100343
44	10	1	072100344
45	10,5	1	072100345
46	11	1	072100346
47	12	1	072100347
48	13	1	072100348

CE



S1P SRC

7210PB

scarpe in pelle scamosciata traforata

- Puntale in composito
- Lamina antiperforazione in fibra composita



EU	UK	
35	2,5	1 072100435
36	3,5	1 072100436
37	4,5	1 072100437
38	5	1 072100438
39	6	1 072100439
40	6,5	1 072100440
41	7	1 072100441
42	8	1 072100442
43	9	1 072100443
44	10	1 072100444
45	10,5	1 072100445
46	11	1 072100446
47	12	1 072100447
48	13	1 072100448

CE



Misano



EN ISO
20345
2011



S1P SRC

7211PG

scarpe in pelle scamosciata traforata

- Puntale in composito
- Lamina antiperforazione in fibra composita



EU	UK	
35	2,5	1 072110435
36	3,5	1 072110436
37	4,5	1 072110437
38	5	1 072110438
39	6	1 072110439
40	6,5	1 072110440
41	7	1 072110441
42	8	1 072110442
43	9	1 072110443
44	10	1 072110444
45	10,5	1 072110445
46	11	1 072110446
47	12	1 072110447
48	13	1 072110448

CE



Mugello



EN ISO
20345
2011



S1P SRC

7216BKK

sandali in morbida pelle scamosciata con chiusura a strappo

- Puntale in composito
- Lamina antiperforazione in fibra composita



EU	UK	
35	2,5	1 072160335
36	3,5	1 072160336
37	4,5	1 072160337
38	5	1 072160338
39	6	1 072160339
40	6,5	1 072160340
41	7	1 072160341
42	8	1 072160342
43	9	1 072160343
44	10	1 072160344
45	10,5	1 072160345
46	11	1 072160346
47	12	1 072160347
48	13	1 072160348

CE



EN ISO
20345
2011



S1P SRC

7216SN

sandali in pelle scamosciata traforata con chiusura a strappo

- Puntale in composito
- Lamina antiperforazione in fibra composita



EU	UK	
35	2,5	1 072160435
36	3,5	1 072160436
37	4,5	1 072160437
38	5	1 072160438
39	6	1 072160439
40	6,5	1 072160440
41	7	1 072160441
42	8	1 072160442
43	9	1 072160443
44	10	1 072160444
45	10,5	1 072160445
46	11	1 072160446
47	12	1 072160447
48	13	1 072160448

CE



Suzuka



EN ISO
20345
2011



S1P SRC

7310BKK

scarpe "saldatore" stringate in pelle pieno fiore idrorepellente con rapido sfilamento e protezione frontale con chiusura a strappo.

Suola in gomma ad alta resistenza

- Puntale in acciaio
- Lamina antiperforazione in fibra composita

EN ISO
20345
2011



S3 RS HRO SRC

CE



EU	UK	1	2
38	5	1	073100238
39	6	1	073100239
40	6,5	1	073100240
41	7	1	073100241
42	8	1	073100242
43	9	1	073100243
44	10	1	073100244
45	10,5	1	073100245
46	11	1	073100246
47	12	1	073100247

TREKKING



7235B

scarpe in action nabuk idrorepellente con inserti in nylon

- Puntale in acciaio
- Lamina antiperforazione in acciaio elastico

EN ISO
20345
2011



S3 SRC

CE



EU	UK	1	2
35	2,5	1	072350235
36	3,5	1	072350236
37	4,5	1	072350237
38	5	1	072350238
39	6	1	072350239
40	6,5	1	072350240
41	7	1	072350241
42	8	1	072350242
43	9	1	072350243
44	10	1	072350244
45	10,5	1	072350245
46	11	1	072350246
47	12	1	072350247
48	13	1	072350248

7236B

scarpe alte in action nabuk idrorepellente con inserti in nylon

- Puntale in acciaio
- Lamina antiperforazione in acciaio elastico

EN ISO
20345
2011



S3 SRC

CE



EU	UK	1	2
35	2,5	1	072360235
36	3,5	1	072360236
37	4,5	1	072360237
38	5	1	072360238
39	6	1	072360239
40	6,5	1	072360240
41	7	1	072360241
42	8	1	072360242
43	9	1	072360243
44	10	1	072360244
45	10,5	1	072360245
46	11	1	072360246
47	12	1	072360247
48	13	1	072360248

7248G

scarpe in pelle scamosciata con inserti in mesh

- Puntale in acciaio
- Lamina antiperforazione in acciaio elastico



EU	UK		
35	2,5	1	072480135
36	3,5	1	072480136
37	4,5	1	072480137
38	5	1	072480138
39	6	1	072480139
40	6,5	1	072480140
41	7	1	072480141
42	8	1	072480142
43	9	1	072480143
44	10	1	072480144
45	10,5	1	072480145
46	11	1	072480146
47	12	1	072480147
48	13	1	072480148

CE



S1P SRC

EN ISO
20345
2011



7249G

scarpe alte in pelle scamosciata con inserti in mesh

- Puntale in acciaio
- Lamina antiperforazione in acciaio elastico



EU	UK		
35	2,5	1	072490135
36	3,5	1	072490136
37	4,5	1	072490137
38	5	1	072490138
39	6	1	072490139
40	6,5	1	072490140
41	7	1	072490141
42	8	1	072490142
43	9	1	072490143
44	10	1	072490144
45	10,5	1	072490145
46	11	1	072490146
47	12	1	072490147
48	13	1	072490148

CE



S1P SRC

EN ISO
20345
2011



SNEAKERS



7250NKK

scarpe basse in pelle scamosciata con inserti in nylon

- Puntale in materiale composito
- Lamina antiperforazione in fibra composita



EU	UK		
38	5	1	072500238
39	6	1	072500239
40	6,5	1	072500240
41	7	1	072500241
42	8	1	072500242
43	9	1	072500243
44	10	1	072500244
45	10,5	1	072500245
46	11	1	072500246
47	12	1	072500247

CE



S1P SRC

Sepang



EN ISO
20345
2011



7251NKK

scarpe alte in pelle scamosciata
con inserti in nylon

- Puntale in materiale composito
- Lamina antiperforazione in fibra composita

EN ISO
20345
2011



EU	UK	
38	5	1 072510238
39	6	1 072510239
40	6,5	1 072510240
41	7	1 072510241
42	8	1 072510242
43	9	1 072510243
44	10	1 072510244
45	10,5	1 072510245
46	11	1 072510246
47	12	1 072510247

CE



Sepang



S1P SRC

7252NKK

scarpe basse in pelle nabuk idrorepellente
con inserti in microfibra idrorepellente

- Puntale in materiale composito
- Lamina antiperforazione in fibra composita

EN ISO
20345
2011



EU	UK	
38	5	1 072520138
39	6	1 072520139
40	6,5	1 072520140
41	7	1 072520141
42	8	1 072520142
43	9	1 072520143
44	10	1 072520144
45	10,5	1 072520145
46	11	1 072520146
47	12	1 072520147

CE



Zolder



S3 SRC

7253NKK

scarpe alte in pelle nabuk idrorepellente
con inserti in microfibra idrorepellente

- Puntale in materiale composito
- Lamina antiperforazione in fibra composita

EN ISO
20345
2011



EU	UK	
38	5	1 072530138
39	6	1 072530139
40	6,5	1 072530140
41	7	1 072530141
42	8	1 072530142
43	9	1 072530143
44	10	1 072530144
45	10,5	1 072530145
46	11	1 072530146
47	12	1 072530147

CE



Zolder



S3 SRC

7258NKK

scarpe basse in pelle scamosciata idrorepellente
con inserti in nylon idrorepellente

- Puntale in materiale composito
- Lamina antiperforazione in fibra composita

EN ISO
20345
2011



EU	UK	
38	5	1 072580138
39	6	1 072580139
40	6,5	1 072580140
41	7	1 072580141
42	8	1 072580142
43	9	1 072580143
44	10	1 072580144
45	10,5	1 072580145
46	11	1 072580146
47	12	1 072580147

CE



Le Mans



S3 SRC

7259NKK

scarpe alte in pelle scamosciata idrorepellente con inserti in nylon idrorepellente

- Puntale in materiale composito
- Lamina antiperforazione in fibra composita



EU	UK	EU	UK
38	5	1	072590138
39	6	1	072590139
40	6,5	1	072590140
41	7	1	072590141
42	8	1	072590142
43	9	1	072590143
44	10	1	072590144
45	10,5	1	072590145
46	11	1	072590146
47	12	1	072590147

CE



Le Mans



EN ISO 20345 2011



S3 SRC

7313B

scarpe in pelle scamosciata con inserti in nylon mesh e PU

- Puntale in fibra di vetro
- Lamina antiperforazione in fibra composita



EU	UK	EU	UK
35	2,5	1	073130835
36	3,5	1	073130836
37	4,5	1	073130837
38	5	1	073130838
39	6	1	073130839
40	6,5	1	073130840
41	7	1	073130841
42	8	1	073130842
43	9	1	073130843
44	10	1	073130844
45	10,5	1	073130845
46	11	1	073130846
47	12	1	073130847
48	13	1	073130848

CE



Monza



EN ISO 20345 2011



S1P SRC

7313G

scarpe in pelle scamosciata con inserti in nylon mesh e PU

- Puntale in fibra di vetro
- Lamina antiperforazione in fibra composita



EU	UK	EU	UK
35	2,5	1	073130635
36	3,5	1	073130636
37	4,5	1	073130637
38	5	1	073130638
39	6	1	073130639
40	6,5	1	073130640
41	7	1	073130641
42	8	1	073130642
43	9	1	073130643
44	10	1	073130644
45	10,5	1	073130645
46	11	1	073130646
47	12	1	073130647
48	13	1	073130648

CE



Monza



EN ISO 20345 2011



S1P SRC

7313T

scarpe in pelle scamosciata con inserti in nylon mesh e PU

- Puntale in fibra di vetro
- Lamina antiperforazione in fibra composita



EU	UK	EU	UK
35	2,5	1	073130735
36	3,5	1	073130736
37	4,5	1	073130737
38	5	1	073130738
39	6	1	073130739
40	6,5	1	073130740
41	7	1	073130741
42	8	1	073130742
43	9	1	073130743
44	10	1	073130744
45	10,5	1	073130745
46	11	1	073130746
47	12	1	073130747
48	13	1	073130748

CE



Monza



EN ISO 20345 2011



S1P SRC

7316N

scarpe in pelle scamosciata idrorepellente
con inserto in microfibra

- Puntale in fibra di vetro
- Lamina antiperforazione in fibra composita

EN ISO
20345
2011



EU	UK	US	JP
35	2,5		1 073160535
36	3,5		1 073160536
37	4,5		1 073160537
38	5		1 073160538
39	6		1 073160539
40	6,5		1 073160540
41	7		1 073160541
42	8		1 073160542
43	9		1 073160543
44	10		1 073160544
45	10,5		1 073160545
46	11		1 073160546
47	12		1 073160547
48	13		1 073160548



Assen



CE

S3 SRC

7320M

scarpe in pelle scamosciata idrorepellente
con inserto in microfibra

- Puntale in fibra di vetro
- Lamina antiperforazione in fibra composita

EN ISO
20345
2011



EU	UK	US	JP
35	2,5		1 073200335
36	3,5		1 073200336
37	4,5		1 073200337
38	5		1 073200338
39	6		1 073200339
40	6,5		1 073200340
41	7		1 073200341
42	8		1 073200342
43	9		1 073200343
44	10		1 073200344
45	10,5		1 073200345
46	11		1 073200346
47	12		1 073200347
48	13		1 073200348



Estopi



CE

S3 SRC

7323M

scarpe alte in pelle scamosciata idrorepellente
con inserto in microfibra

- Puntale in fibra di vetro
- Lamina antiperforazione in fibra composita

EN ISO
20345
2011



EU	UK	US	JP
35	2,5		1 073230335
36	3,5		1 073230336
37	4,5		1 073230337
38	5		1 073230338
39	6		1 073230339
40	6,5		1 073230340
41	7		1 073230341
42	8		1 073230342
43	9		1 073230343
44	10		1 073230344
45	10,5		1 073230345
46	11		1 073230346
47	12		1 073230347
48	13		1 073230348



Estopi



CE

S3 SRC

7334T

mocassini in pelle scamosciata
con inserti in nylon mesh e PU

- Puntale in fibra di vetro
- Lamina antiperforazione in fibra composita

EN ISO
20345
2011



EU	UK	US	JP
35	2,5		1 073340335
36	3,5		1 073340336
37	4,5		1 073340337
38	5		1 073340338
39	6		1 073340339
40	6,5		1 073340340
41	7		1 073340341
42	8		1 073340342
43	9		1 073340343
44	10		1 073340344
45	10,5		1 073340345
46	11		1 073340346
47	12		1 073340347
48	13		1 073340348



Jerez



CE

S1P SRC

URBAN



7360UN

scarpe basse in pelle scamosciata idrorepellente

- Puntale in composito
- Lamina antiperforazione in fibra composita



EU	UK	
35	2,5	1 073600335
36	3,5	1 073600336
37	4,5	1 073600337
38	5	1 073600338
39	6	1 073600339
40	6,5	1 073600340
41	7	1 073600341
42	8	1 073600342
43	9	1 073600343
44	10	1 073600344
45	10,5	1 073600345
46	11	1 073600346
47	12	1 073600347
48	13	1 073600348



CE

S3 SRC

EN ISO
20345
2011



7361UB

scarpe basse in pelle scamosciata traforata con inserti in tessuto canvas traspirante

- Puntale in composito
- Lamina antiperforazione in fibra composita



EU	UK	
35	2,5	1 073610235
36	3,5	1 073610236
37	4,5	1 073610237
38	5	1 073610238
39	6	1 073610239
40	6,5	1 073610240
41	7	1 073610241
42	8	1 073610242
43	9	1 073610243
44	10	1 073610244
45	10,5	1 073610245
46	11	1 073610246
47	12	1 073610247
48	13	1 073610248



CE

S1P SRC

EN ISO
20345
2011



7361UM

scarpe basse in pelle scamosciata traforata con inserti in tessuto canvas traspirante

- Puntale in composito
- Lamina antiperforazione in fibra composita



EU	UK	
35	2,5	1 073610335
36	3,5	1 073610336
37	4,5	1 073610337
38	5	1 073610338
39	6	1 073610339
40	6,5	1 073610340
41	7	1 073610341
42	8	1 073610342
43	9	1 073610343
44	10	1 073610344
45	10,5	1 073610345
46	11	1 073610346
47	12	1 073610347
48	13	1 073610348



CE

S1P SRC

EN ISO
20345
2011



7368UG

scarpe alte in pelle scamosciata idrorepellente
Collare in morbido tessuto con imbottitura paramalleolo

- Puntale in composito
- Lamina antiperforazione in fibra composita

EN ISO
20345
2011



EU	UK		
35	2,5	1	073680435
36	3,5	1	073680436
37	4,5	1	073680437
38	5	1	073680438
39	6	1	073680439
40	6,5	1	073680440
41	7	1	073680441
42	8	1	073680442
43	9	1	073680443
44	10	1	073680444
45	10,5	1	073680445
46	11	1	073680446
47	12	1	073680447
48	13	1	073680448



CE

S3 SRC

7368UM

scarpe alte in pelle scamosciata idrorepellente
Collare in morbido tessuto con imbottitura paramalleolo

- Puntale in composito
- Lamina antiperforazione in fibra composita

EN ISO
20345
2011



EU	UK		
35	2,5	1	073680535
36	3,5	1	073680536
37	4,5	1	073680537
38	5	1	073680538
39	6	1	073680539
40	6,5	1	073680540
41	7	1	073680541
42	8	1	073680542
43	9	1	073680543
44	10	1	073680544
45	10,5	1	073680545
46	11	1	073680546
47	12	1	073680547
48	13	1	073680548



CE

S3 SRC

7368UN

scarpe alte in pelle scamosciata idrorepellente
Collare in morbido tessuto con imbottitura paramalleolo

- Puntale in composito
- Lamina antiperforazione in fibra composita

EN ISO
20345
2011



EU	UK		
35	2,5	1	073680335
36	3,5	1	073680336
37	4,5	1	073680337
38	5	1	073680338
39	6	1	073680339
40	6,5	1	073680340
41	7	1	073680341
42	8	1	073680342
43	9	1	073680343
44	10	1	073680344
45	10,5	1	073680345
46	11	1	073680346
47	12	1	073680347
48	13	1	073680348



CE

S3 SRC

7369UB

scarpe alte in pelle scamosciata idrorepellente
Collare in morbido tessuto con imbottitura paramalleolo

- Puntale in composito
- Lamina antiperforazione in fibra composita

EN ISO
20345
2011



EU	UK		
35	2,5	1	073690235
36	3,5	1	073690236
37	4,5	1	073690237
38	5	1	073690238
39	6	1	073690239
40	6,5	1	073690240
41	7	1	073690241
42	8	1	073690242
43	9	1	073690243
44	10	1	073690244
45	10,5	1	073690245
46	11	1	073690246
47	12	1	073690247
48	13	1	073690248



CE

S3 SRC

SNEAKERS PRO



7340B

scarpe in tessuto mesh ad alta traspirazione
con inserti in PU Alta Frequenza e rinforzo protettivo
del puntale in crosta scamosciata.
Estremamente leggere - peso indicativo misura 42: **470 g**

- Puntale in alluminio
- Lamina antiperforazione in fibra composita
- Sistema di chiusura FixLock, semplifica la calzata e lo sfilamento della scarpa (in dotazione anche stringhe tradizionali)

**EN ISO
20345
2011**



EU	UK	1	2
36	3,5	1	073400236
37	4,5	1	073400237
38	5	1	073400238
39	6	1	073400239
40	6,5	1	073400240
41	7	1	073400241
42	8	1	073400242
43	9	1	073400243
44	10	1	073400244
45	10,5	1	073400245
46	11	1	073400246
47	12	1	073400247



FIT PRO NET



CE

S1P SRC

7340Y

scarpe in tessuto mesh ad alta traspirazione
con inserti in PU Alta Frequenza e rinforzo protettivo
del puntale in crosta scamosciata.
Estremamente leggere - peso indicativo misura 42: **470 g**

- Puntale in alluminio
- Lamina antiperforazione in fibra composita
- Sistema di chiusura FixLock, semplifica la calzata e lo sfilamento della scarpa (in dotazione anche stringhe tradizionali)

**EN ISO
20345
2011**



EU	UK	1	2
36	3,5	1	073400336
37	4,5	1	073400337
38	5	1	073400338
39	6	1	073400339
40	6,5	1	073400340
41	7	1	073400341
42	8	1	073400342
43	9	1	073400343
44	10	1	073400344
45	10,5	1	073400345
46	11	1	073400346
47	12	1	073400347



FIT PRO NET



CE

S1P SRC

7341N

scarpe in micro pelle scamosciata idrorepellente
con inserti in PU Alta Frequenza e rinforzo protettivo
del puntale in crosta scamosciata.
Estremamente leggere - peso indicativo misura 42: **470 g**

- Puntale in alluminio
- Lamina antiperforazione in fibra composita
- Sistema di chiusura FixLock, semplifica la calzata e lo sfilamento della scarpa (in dotazione anche stringhe tradizionali)

**EN ISO
20345
2011**



EU	UK	1	2
36	3,5	1	073410236
37	4,5	1	073410237
38	5	1	073410238
39	6	1	073410239
40	6,5	1	073410240
41	7	1	073410241
42	8	1	073410242
43	9	1	073410243
44	10	1	073410244
45	10,5	1	073410245
46	11	1	073410246
47	12	1	073410247



FIT PRO



CE

S3 SRC

7349RP

scarpe in crosta nabukata idrorepellente
con suola in gomma e anello in morbido PU

- Puntale in composito
- Lamina antiperforazione in fibra composita

EN ISO
20345
2011



EU	UK	
38	5	1 073490138
39	6	1 073490139
40	6,5	1 073490140
41	7	1 073490141
42	8	1 073490142
43	9	1 073490143
44	10	1 073490144
45	10,5	1 073490145
46	11	1 073490146
47	12	1 073490147



CE

S3 HRO SRC

7350RP

scarpe alte in crosta nabukata idrorepellente
con suola in gomma e anello in morbido PU

- Puntale in composito
- Lamina antiperforazione in fibra composita

EN ISO
20345
2011



EU	UK	
38	5	1 073500138
39	6	1 073500139
40	6,5	1 073500140
41	7	1 073500141
42	8	1 073500142
43	9	1 073500143
44	10	1 073500144
45	10,5	1 073500145
46	11	1 073500146
47	12	1 073500147



CE

S3 HRO SRC

MANAGER



7290AKK

scarpe in pelle pieno fiore idrorepellente
ad alta traspirazione

- Puntale in composito
- Lamina antiperforazione in fibra composita

EN ISO
20345
2011



EU	UK	
38	5	1 072900238
39	6	1 072900239
40	6,5	1 072900240
41	7	1 072900241
42	8	1 072900242
43	9	1 072900243
44	10	1 072900244
45	10,5	1 072900245
46	11	1 072900246
47	12	1 072900247
48	13	1 072900248



CE

S3 SRC

7291AKK

scarpe alte in pelle pieno fiore idrorepellente ad alta traspirazione

- Puntale in composito
- Lamina antiperforazione in fibra composita



EU	UK	
38	5	1 072910238
39	6	1 072910239
40	6,5	1 072910240
41	7	1 072910241
42	8	1 072910242
43	9	1 072910243
44	10	1 072910244
45	10,5	1 072910245
46	11	1 072910246
47	12	1 072910247
48	13	1 072910248

CE



EN ISO 20345 2011



S3 SRC

7300B

scarpe "free time" in pelle pieno fiore idrorepellente, senza puntale e lamina antiperforazione

- Senza puntale
- Senza lamina antiperforazione



EU	UK	
36	3,5	1 073000536
37	4,5	1 073000537
38	5	1 073000538
39	6	1 073000539
40	6,5	1 073000540
41	7	1 073000541
42	8	1 073000542
43	9	1 073000543
44	10	1 073000544
45	10,5	1 073000545
46	11	1 073000546
47	12	1 073000547
48	13	1 073000548

CE



EN ISO 20347 2012



O2 FO SRC

7300BKK

scarpe in pelle pieno fiore ad alta traspirazione

- Puntale in composito
- Lamina antiperforazione in fibra composita



EU	UK	
36	3,5	1 073000236
37	4,5	1 073000237
38	5	1 073000238
39	6	1 073000239
40	6,5	1 073000240
41	7	1 073000241
42	8	1 073000242
43	9	1 073000243
44	10	1 073000244
45	10,5	1 073000245
46	11	1 073000246
47	12	1 073000247
48	13	1 073000248

CE



EN ISO 20345 2011



S3 SRC

7318ESD

scarpe in pelle scamosciata traforata, ESD

- Puntale in composito
- Lamina antiperforazione in fibra composita



EU	UK	
36	3,5	1 073180136
37	4,5	1 073180137
38	5	1 073180138
39	6	1 073180139
40	6,5	1 073180140
41	7	1 073180141
42	8	1 073180142
43	9	1 073180143
44	10	1 073180144
45	10,5	1 073180145
46	11	1 073180146
47	12	1 073180147
48	13	1 073180148

CE



EN ISO 20345 2011



S1P SRC

HEAVY DUTY



7293NB

scarpe in pelle Nabuk ingrassata idrorepellente con inserto antiabrasione in microfibra e suola in gomma ad alta resistenza
Supporto per il contenimento laterale della caviglia

- Puntale in alluminio
- Lamina antiperforazione in fibra composita

EN ISO 20345 2011



EU	UK	1	072930538
38	5	1	072930538
39	6	1	072930539
40	6,5	1	072930540
41	7	1	072930541
42	8	1	072930542
43	9	1	072930543
44	10	1	072930544
45	10,5	1	072930545
46	11	1	072930546
47	12	1	072930547
48	13	1	072930548

CE

Daytona



S3 HRO SRC

7293NG

scarpe in pelle Nabuk ingrassata idrorepellente con inserto antiabrasione in microfibra e suola in gomma ad alta resistenza
Supporto per il contenimento laterale della caviglia

- Puntale in alluminio
- Lamina antiperforazione in fibra composita

EN ISO 20345 2011



EU	UK	1	072930438
38	5	1	072930438
39	6	1	072930439
40	6,5	1	072930440
41	7	1	072930441
42	8	1	072930442
43	9	1	072930443
44	10	1	072930444
45	10,5	1	072930445
46	11	1	072930446
47	12	1	072930447
48	13	1	072930448

CE

Daytona



S3 HRO SRC

7293NKK

scarpe in pelle Nabuk ingrassata con dynamic control e suola in gomma VIBRAM® ad alta resistenza

- Puntale in composito
- Lamina antiperforazione in fibra composita

EN ISO 20345 2011



EU	UK	1	072930138
38	5	1	072930138
39	6	1	072930139
40	6,5	1	072930140
41	7	1	072930141
42	8	1	072930142
43	9	1	072930143
44	10	1	072930144
45	10,5	1	072930145
46	11	1	072930146
47	12	1	072930147
48	13	1	072930148

CE



S3 HRO SRC

7294NB

scarpe alte in pelle Nabuk ingrassata idrorepellente
con inserto antiabrasione in microfibra e suola in gomma ad
alta resistenza

Supporto per il contenimento laterale della caviglia

- Puntale in alluminio
- Lamina antiperforazione in fibra composita



EU	UK		
38	5	1	072940538
39	6	1	072940539
40	6,5	1	072940540
41	7	1	072940541
42	8	1	072940542
43	9	1	072940543
44	10	1	072940544
45	10,5	1	072940545
46	11	1	072940546
47	12	1	072940547
48	13	1	072940548

CE



Daytona

S3 HRO SRC

EN ISO
20345
2011

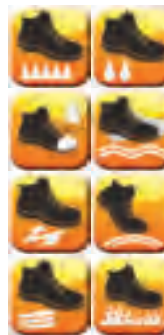

7294NG

scarpe alte in pelle Nabuk ingrassata idrorepellente
con inserto antiabrasione in microfibra e suola in gomma ad
alta resistenza

Supporto per il contenimento laterale della caviglia

- Puntale in alluminio
- Lamina antiperforazione in fibra composita



EU	UK		
38	5	1	072940438
39	6	1	072940439
40	6,5	1	072940440
41	7	1	072940441
42	8	1	072940442
43	9	1	072940443
44	10	1	072940444
45	10,5	1	072940445
46	11	1	072940446
47	12	1	072940447
48	13	1	072940448

CE



Daytona

S3 HRO SRC

EN ISO
20345
2011



7294NKK

scarpe alte in pelle Nabuk ingrassata
con dynamic control e suola in gomma VIBRAM® ad alta
resistenza

- Puntale in composito
- Lamina antiperforazione in fibra composita



EU	UK		
38	5	1	072940138
39	6	1	072940139
40	6,5	1	072940140
41	7	1	072940141
42	8	1	072940142
43	9	1	072940143
44	10	1	072940144
45	10,5	1	072940145
46	11	1	072940146
47	12	1	072940147
48	13	1	072940148

CE



S3 HRO SRC

EN ISO
20345
2011



7294TKK

scarpe alte in pelle Nabuk ingrassata
con membrana in Thinsulate™, dynamic control e suola in
gomma VIBRAM® ad alta resistenza

- Puntale in composito
- Lamina antiperforazione in fibra composita



EU	UK		
38	5	1	072940238
39	6	1	072940239
40	6,5	1	072940240
41	7	1	072940241
42	8	1	072940242
43	9	1	072940243
44	10	1	072940244
45	10,5	1	072940245
46	11	1	072940246
47	12	1	072940247
48	13	1	072940248

CE



S3 HRO CI HI SRC

EN ISO
20345
2011



7295

stivali in pelle pieno fiore idrorepellente con suola in gomma VIBRAM® ad alta resistenza. Battistrada "Iron Tire", studiato per migliorare l'aderenza su terreni instabili e superfici ghiacciate

- Puntale in composito
- Lamina antiperforazione in fibra composita

EN ISO
20345
2011



EU	UK		
39	6	1	072950139
40	6,5	1	072950140
41	7	1	072950141
42	8	1	072950142
43	9	1	072950143
44	10	1	072950144
45	10,5	1	072950145
46	11	1	072950146

CE



Enduro



S3 HRO CI SRC

7327NKK

stivali "POLAR" in pelle pieno fiore idrorepellente, con scarpetta estraibile

- Puntale in composito
- Lamina antiperforazione in fibra composita

EN ISO
20345
2011



EU	UK		
39	6	1	073270039
40	6,5	1	073270040
41	7	1	073270041
42	8	1	073270042
43	9	1	073270043
44	10	1	073270044
45	10,5	1	073270045
46	11	1	073270046

CE



7327R

S3 HRO SRA

7327R

scarpette interne per stivali 7327NKK



EU	UK		
39	6	1	073270939
40	6,5	1	073270940
41	7	1	073270941
42	8	1	073270942
43	9	1	073270943
44	10	1	073270944
45	10,5	1	073270945
46	11	1	073270946



7330NV

stivali in pelle nabuk ingrassata idrorepellente con membrana in Thinsulate™ e suola in gomma VIBRAM® ad alta resistenza. Foderati in pelliccia di vera lana

- Puntale in composito
- Lamina antiperforazione in fibra composita

EN ISO
20345
2011



EU	UK		
38	5	1	073300438
39	6	1	073300439
40	6,5	1	073300440
41	7	1	073300441
42	8	1	073300442
43	9	1	073300443
44	10	1	073300444
45	10,5	1	073300445
46	11	1	073300446
47	12	1	073300447
48	13	1	073300448

CE



S3 HRO CI SRC

ACCESSORIES



7398AL

sottopiedi per basse temperature in feltro alluminizzato



EU	UK		
38	5	1	073980538
39	6	1	073980539
40	6,5	1	073980540
41	7	1	073980541
42	8	1	073980542
43	9	1	073980543
44	10	1	073980544
45	10,5	1	073980545
46	11	1	073980546
47	12	1	073980547
48	13	1	073980548

7398BF

sottopiedi anatomici "BLOW-FEET"



EU	UK		
36	3,5	1	073980336
37	4,5	1	073980337
38	5	1	073980338
39	6	1	073980339
40	6,5	1	073980340
41	7	1	073980341
42	8	1	073980342
43	9	1	073980343
44	10	1	073980344
45	10,5	1	073980345
46	11	1	073980346
47	12	1	073980347
48	13	1	073980348

7398GEL

sottopiedi anatomici con inserto in gel



EU	UK		
35	2,5	1	073980835
36	3,5	1	073980836
37	4,5	1	073980837
38	5	1	073980838
39	6	1	073980839
40	6,5	1	073980840
41	7	1	073980841
42	8	1	073980842
43	9	1	073980843
44	10	1	073980844
45	10,5	1	073980845
46	11	1	073980846
47	12	1	073980847
48	13	1	073980848

7398CX

sottopiedi anatomici Coolmax®



EU	UK		
35	2,5	1	073980935
36	3,5	1	073980936
37	4,5	1	073980937
38	5	1	073980938
39	6	1	073980939
40	6,5	1	073980940
41	7	1	073980941
42	8	1	073980942
43	9	1	073980943
44	10	1	073980944
45	10,5	1	073980945
46	11	1	073980946
47	12	1	073980947
48	13	1	073980948

7398ST

sottopiedi anatomici On Steam



EU	UK		
35	2,5	1	073981035
36	3,5	1	073981036
37	4,5	1	073981037
38	5	1	073981038
39	6	1	073981039
40	6,5	1	073981040
41	7	1	073981041
42	8	1	073981042
43	9	1	073981043
44	10	1	073981044
45	10,5	1	073981045
46	11	1	073981046
47	12	1	073981047
48	13	1	073981048

7398 TNT

sottopiedi intercambiabili in CARBON



EU	UK		
35	2,5	1	073980035
36	3,5	1	073980036
37	4,5	1	073980037
38	5	1	073980038
39	6	1	073980039
40	6,5	1	073980040
41	7	1	073980041
42	8	1	073980042
43	9	1	073980043
44	10	1	073980044
45	10,5	1	073980045
46	11	1	073980046
47	12	1	073980047
48	13	1	073980048

7399 A/N...

confezione 10 paia di stringhe



	cm		
7399 A/N100	100	1	073990010
7399 A/N120	120	1	073990012
7399 A/N140	140	1	073990017

I prezzi indicati sono relativi a 10 paia

7399B...

confezione 10 paia di stringhe beige



	cm		
7399B 90	90	1	073990015
7399B 120	120	1	073990016

I prezzi indicati sono relativi a 10 paia

7399G...

confezione 10 paia di stringhe grigie



	cm		
7399G 110	110	1	073990018

I prezzi indicati sono relativi a 10 paia



7410

calzini in polipropilene con piede in cotone e Cupron®



	EU		
S	37-39	1	074100001
M	40-42	1	074100002
L	43-45	1	074100003
XL	46-48	1	074100004

7413

calzini in spugna e poliammide.
calzata destra e sinistra



	EU		
S	37-39	1	074130001
M	40-42	1	074130002
L	43-45	1	074130003
XL	46-48	1	074130004

7417

calzini in Tactel®



	EU		
S	37-39	1	074170001
M	40-42	1	074170002
L	43-45	1	074170003
XL	46-48	1	074170004

7415

calzini in Coolmax®, Dryarn® e Cordura®



	EU		
S	37-39	1	074150001
M	40-42	1	074150002
L	43-45	1	074150003
XL	46-48	1	074150004

7416

calze in Coolmax®, Dryarn® e Cordura®



	EU		
S	37-39	1	074160001
M	40-42	1	074160002
L	43-45	1	074160003
XL	46-48	1	074160004

7418

calzini in Meryl Skinlife® antibatterico



	EU		
S	37-39	1	074180001
M	40-42	1	074180002
L	43-45	1	074180003
XL	46-48	1	074180004



WORK

La linea di abbigliamento da lavoro ha conquistato nel corso degli anni la fiducia e la preferenza dei professionisti più esigenti. Il successo del prodotto ha generato la costante evoluzione e l'ampliamento della gamma di offerta.

I capi di abbigliamento prodotti da Beta Utensili S.p.a. sono conformi alla seguente normativa:

EN ISO 13688:2013

Il DPI protegge l'utilizzatore dai rischi fisici di lieve entità come: piccole abrasioni, raggi solari, vento, freddo polveri non nocive ed imbrattamento da materiali non tossici. Tale protezione è riconducibile alla prima categoria del DDL 475 del 04/12/1992.

ISTRUZIONI PER L'UTILIZZO E LA CONSERVAZIONE

Il capo va indossato correttamente in modo che possa proteggere le parti del corpo dell'utilizzatore. Il capo va conservato in un luogo fresco ed asciutto, nel suo imballaggio originale, al riparo da fonti di calore, luce solare, polvere ed agenti atmosferici.

CONFEZIONAMENTO

- ♣️ BBIGLIAMENTO DA LAVORO:
busta appendibile
- ♣️ BBIGLIAMENTO TEMPO LIBERO:
busta non appendibile

RESTRINGIMENTO

Tutte le fibre naturali si restringono dopo il lavaggio in acqua. Il restringimento può variare dall'1% al 5% in funzione di diversi parametri, in particolare il tipo di fibra e la temperatura dell'acqua.



	I	F	D	E	UK	USA
XS	46	38	42	40	30	32
S	48	40	44	42	32	34
M	50	42	46	44	34	36
L	52	44	48	46	36	38
XL	54	46	50	48	38	40
XXL	56	48	52	50	40	42
XXXL	58	50	54	52	42	44
4XL	60	52	56	54	44	46

Beta		EN ISO 13688:2013							
	XS	S	M	L	XL	2XL	3XL	4XL	
A	68-92	92-96	96-104	104-108	108-116	116-124	124-132	132-140	
B	79-83	83-87	87-91	91-95	95-100	100-107	107-112	112-120	
H	158-164	164-170	170-176	176-182	182-188	188-194	194-200	200-206	

PANTS



7505M

pantaloni multitasche mimetici
in 100% cotone twill 260 g

CE



XS	1	075050246
S	1	075050248
M	1	075050250
L	1	075050252
XL	1	075050254
XXL	1	075050256
XXXL	1	075050258

7515M

bermuda multitasche mimetici
in 100% cotone twill 260 g

CE



XS	1	075150246
S	1	075150248
M	1	075150250
L	1	075150252
XL	1	075150254
XXL	1	075150256
XXXL	1	075150258

7525

jeans da lavoro elasticizzati prelavati
in 68% cotone denim, 29% poliestere,
3% tessuto elasticizzato, 10OZ

CE



XS	1	075250046
S	1	075250048
M	1	075250050
L	1	075250052
XL	1	075250054
XXL	1	075250056
XXXL	1	075250058

7526

jeans da lavoro elasticizzati prelavati
in 68% cotone denim, 29% poliestere,
3% tessuto elasticizzato, 10 OZ
Rinforzi in poliestere 600D all'interno delle
tasche posteriori e sul fondo gamba. Slim fit

CE



XS	1	075260046
S	1	075260048
M	1	075260050
L	1	075260052
XL	1	075260054
XXL	1	075260056
XXXL	1	075260058

7815N

pantaloni da lavoro multitasche
in T/C canvas ritorto 280 g
con inserti in poliestere, nero

CE



XS	1	078150000
S	1	078150001
M	1	078150002
L	1	078150003
XL	1	078150004
XXL	1	078150005
XXXL	1	078150006

7816BL

pantaloni da lavoro multitasche in T/C Canvas 260 g, blu
Tasche per ginocchiere e fondo gamba rinforzati in poliestere 600D, cavallo antistrappo ed inserto elastico posteriore per facilitare i movimenti

CE



Dimensione	Quantità	Articolo
XS	1	078160100
S	1	078160101
M	1	078160102
L	1	078160103
XL	1	078160104
XXL	1	078160105
XXXL	1	078160106

7816G

pantaloni da lavoro multitasche in T/C Canvas 260 g, grigio
Tasche per ginocchiere e fondo gamba rinforzati in poliestere 600D, cavallo antistrappo ed inserto elastico posteriore per facilitare i movimenti

CE



Dimensione	Quantità	Articolo
XS	1	078160000
S	1	078160001
M	1	078160002
L	1	078160003
XL	1	078160004
XXL	1	078160005
XXXL	1	078160006

7816ST

pantaloni da lavoro elasticizzati in T/C Twill 250 g, grigio
Slim fit, cavallo antistrappo e vita elasticizzata ai lati

CE



Dimensione	Quantità	Articolo
XS	1	078160200
S	1	078160201
M	1	078160202
L	1	078160203
XL	1	078160204
XXL	1	078160205
XXXL	1	078160206

SHIRT & T-SHIRT



7546BL

polo 3 bottoni in cotone piqué 220 g, blu

CE



Dimensione	Quantità	Articolo
XS	2	075460000
S	2	075460001
M	2	075460002
L	2	075460003
XL	2	075460004
XXL	2	075460005
XXXL	2	075460006

7546G

polo 3 bottoni in cotone piqué 220 g, grigio

CE



Dimensione	Quantità	Articolo
XS	2	075460100
S	2	075460101
M	2	075460102
L	2	075460103
XL	2	075460104
XXL	2	075460105
XXXL	2	075460106

7546N

polo 3 bottoni in cotone piqué 220 g, nero

CE



Dimensione	Quantità	Articolo
XS	2	075460200
S	2	075460201
M	2	075460202
L	2	075460203
XL	2	075460204
XXL	2	075460205
XXXL	2	075460206

7548BL

t-shirt work in 100% cotone jersey 180 g, blu

CE



Dimensione	Quantità	Articolo
XS	5	075480000
S	5	075480001
M	5	075480002
L	5	075480003
XL	5	075480004
XXL	5	075480005
XXXL	5	075480006

7548G

t-shirt work in 100% cotone jersey 180 g, grigio

CE



Dimensione	Quantità	Articolo
XS	5	075480100
S	5	075480101
M	5	075480102
L	5	075480103
XL	5	075480104
XXL	5	075480105
XXXL	5	075480106

7548N

t-shirt work in 100% cotone jersey 180 g, nero

CE



Dimensione	Quantità	Articolo
XS	5	075480200
S	5	075480201
M	5	075480202
L	5	075480203
XL	5	075480204
XXL	5	075480205
XXXL	5	075480206

FLEECE



7622G

giacca in pile 280 g con inserti in poliestere, grigio antracite/nero

CE



Dimensione	Quantità	Articolo
XS	1	076220000
S	1	076220001
M	1	076220002
L	1	076220003
XL	1	076220004
XXL	1	076220005
XXXL	1	076220006

Beta

7632G

pull in pile 280 g con inserti in poliestere, grigio antracite/nero

CE



Dimensione	Quantità	Articolo
XS	1	076320000
S	1	076320001
M	1	076320002
L	1	076320003
XL	1	076320004
XXL	1	076320005
XXXL	1	076320006

7635G

micropile zip corta 180 g grigio antracite

CE



Dimensione	Quantità	Articolo
XS	1	076350510
S	1	076350511
M	1	076350512
L	1	076350513
XL	1	076350514
XXL	1	076350515
XXXL	1	076350516

7635N

micropile zip corta 180 g nero

CE



Dimensione	Quantità	Articolo
XS	1	076350500
S	1	076350501
M	1	076350502
L	1	076350503
XL	1	076350504
XXL	1	076350505
XXXL	1	076350506

JACKETS

7575A

gilet in ripstop impermeabilizzato 200 g imbottito e foderato, nero

CE



Dimensione	Quantità	Articolo
XS	1	075750200
S	1	075750201
M	1	075750202
L	1	075750203
XL	1	075750204
XXL	1	075750205
XXXL	1	075750206

7577N

gilet in 100% poliestere microfibra 50D imbottito e foderato, nero
Insero elastico sul giromanica

CE



Dimensione	Quantità	Articolo
XS	1	075770000
S	1	075770001
M	1	075770002
L	1	075770003
XL	1	075770004
XXL	1	075770005
XXXL	1	075770006

7578G

gilet in nylon ripstop impermeabilizzato imbottito e foderato, grigio antracite.
Giromanica elasticizzata

CE



Dimensione	Quantità	Articolo
XS	1	075780000
S	1	075780001
M	1	075780002
L	1	075780003
XL	1	075780004
XXL	1	075780005
XXXL	1	075780006

7683

giacca softshell 94% poliestere, 6% spandex, 290 g con cappuccio e maniche staccabili, nero/arancio
Tessuto idrorepellente a tre strati, dotato di membrana TPU impermeabile, antivento e traspirante

CE



Dimensione	Quantità	Articolo
S	1	076830001
M	1	076830002
L	1	076830003
XL	1	076830004
XXL	1	076830005
XXXL	1	076830006

7684

giacca softshell 94% poliestere, 6% spandex, 290 g nero/grigio
Tessuto idrorepellente a tre strati, dotato di membrana TPU impermeabile, antivento e traspirante

CE



Dimensione	Quantità	Articolo
S	1	076840001
M	1	076840002
L	1	076840003
XL	1	076840004
XXL	1	076840005
XXXL	1	076840006

7685

bomber in nylon 20D con imbottitura effetto piuma in poliestere 80 g, nero
Dotato di pratica custodia salva spazio

CE



Dimensione	Quantità	Articolo
S	1	076850001
M	1	076850002
L	1	076850003
XL	1	076850004
XXL	1	076850005
XXXL	1	076850006

7685BL

bomber in nylon 20D con imbottitura effetto piuma in poliestere 80 g, blu
Dotato di pratica custodia salva spazio

CE



Dimensione	Quantità	Articolo
S	1	076850101
M	1	076850102
L	1	076850103
XL	1	076850104
XXL	1	076850105
XXXL	1	076850106

7733

parka in poliestere Oxford 300D impermeabilizzato, con spalmatura in PU, nero
Cappuccio a scomparsa ed imbottitura in poliestere 180 g

CE



Dimensione	Quantità	Articolo
S	1	077330001
M	1	077330002
L	1	077330003
XL	1	077330004
XXL	1	077330005
XXXL	1	077330006

7734

giaccone triplo uso in poliestere Oxford 300D impermeabilizzato, con spalmatura in PU, grigio

Dotato di cappuccio a scomparsa e giacca interna staccabile in 100% poliestere, nera

CE



Dimensione	Quantità	Articolo
S	1	077340001
M	1	077340002
L	1	077340003
XL	1	077340004

7780N

giaccone in 100% poliestere dooby 230D impermeabilizzato, imbottito e foderato, nero
Cappuccio e maniche staccabili

CE



Dimensione	Quantità	Articolo
XS	1	077800000
S	1	077800001
M	1	077800002
L	1	077800003
XL	1	077800004
XXL	1	077800005
XXXL	1	077800006

BASIC

7840BL

pantaloni da lavoro in T/C twill 245 g, blu
Vita elasticizzata ai lati

CE

Beta EASY



Dimensione	Quantità	Articolo
XS	1	078400100
S	1	078400101
M	1	078400102
L	1	078400103
XL	1	078400104
XXL	1	078400105
XXXL	1	078400106
XXXXL	1	078400107

7849BL

giacca da lavoro in T/C twill 245 g, blu
Fascia in vita elasticizzata

CE

Beta EASY



Dimensione	Quantità	Articolo
XS	1	078490100
S	1	078490101
M	1	078490102
L	1	078490103
XL	1	078490104
XXL	1	078490105
XXXL	1	078490106
XXXXL	1	078490107

EASY LIGHT

7860E

Pantaloni leggeri da lavoro in T/C twill 180 g con inserti in Oxford, grigio

CE

Beta EASY



Dimensione	Quantità	Articolo
XS	1	078600900
S	1	078600901
M	1	078600902
L	1	078600903
XL	1	078600904
XXL	1	078600905
XXXL	1	078600906
XXXXL	1	078600907

7861E

bermuda leggeri da lavoro in T/C twill 180 g, grigio

CE

Beta EASY



Dimensione	Quantità	Articolo
XS	1	078610900
S	1	078610901
M	1	078610902
L	1	078610903
XL	1	078610904
XXL	1	078610905
XXXL	1	078610906
XXXXL	1	078610907

Beta

7863E

salopette leggera da lavoro
in T/C twill 180 g con inserti in Oxford, grigio

CE



XS	1 078630900
S	1 078630901
M	1 078630902
L	1 078630903
XL	1 078630904
XXL	1 078630905
XXXL	1 078630906
XXXXL	1 078630907

7865E

tuta leggera da lavoro
in T/C twill 180 g con inserti in Oxford, grigio

CE



XS	1 078650900
S	1 078650901
M	1 078650902
L	1 078650903
XL	1 078650904
XXL	1 078650905
XXXL	1 078650906
XXXXL	1 078650907

7867E

gilet multitasche leggero da lavoro
in T/C twill 180 g con inserti in Oxford, grigio

CE



XS	1 078670900
S	1 078670901
M	1 078670902
L	1 078670903
XL	1 078670904
XXL	1 078670905
XXXL	1 078670906
XXXXL	1 078670907

7869E

giacca leggera da lavoro in T/C twill 180 g
con inserti in Oxford, grigio

CE



XS	1 078690900
S	1 078690901
M	1 078690902
L	1 078690903
XL	1 078690904
XXL	1 078690905
XXXL	1 078690906
XXXXL	1 078690907

EASY
LIGHT BLUE

7870E

Pantaloni leggeri da lavoro
in T/C twill 180 g con inserti in Oxford, blu

CE



XS	1 078700900
S	1 078700901
M	1 078700902
L	1 078700903
XL	1 078700904
XXL	1 078700905
XXXL	1 078700906
XXXXL	1 078700907

7871E

bermuda leggeri da lavoro
in T/C twill 180 g, blu

CE



XS	1 078710900
S	1 078710901
M	1 078710902
L	1 078710903
XL	1 078710904
XXL	1 078710905
XXXL	1 078710906
XXXXL	1 078710907

Beta

7873E

salopette leggera da lavoro
in T/C twill 180 g con inserti in Oxford, blu

CE

Beta EASY



Dimensione	Quantità	Articolo
XS	1	078730900
S	1	078730901
M	1	078730902
L	1	078730903
XL	1	078730904
XXL	1	078730905
XXXL	1	078730906
XXXXL	1	078730907

7875E

tuta leggera da lavoro
in T/C twill 180 g con inserti in Oxford, blu

CE

Beta EASY



Dimensione	Quantità	Articolo
XS	1	078750900
S	1	078750901
M	1	078750902
L	1	078750903
XL	1	078750904
XXL	1	078750905
XXXL	1	078750906
XXXXL	1	078750907

7877E

giilet multitasche leggero da lavoro
in T/C twill 180 g con inserti in Oxford, blu

CE

Beta EASY



Dimensione	Quantità	Articolo
XS	1	078770900
S	1	078770901
M	1	078770902
L	1	078770903
XL	1	078770904
XXL	1	078770905
XXXL	1	078770906
XXXXL	1	078770907

7879E

giacca leggera da lavoro in T/C twill 180 g
con inserti in Oxford, blu

CE

Beta EASY



Dimensione	Quantità	Articolo
XS	1	078790900
S	1	078790901
M	1	078790902
L	1	078790903
XL	1	078790904
XXL	1	078790905
XXXL	1	078790906
XXXXL	1	078790907

7900E

pantaloni da lavoro multitasche
in T/C canvas 260 g, inserti in Oxford, grigio

CE

Beta EASY



Dimensione	Quantità	Articolo
XS	1	079000900
S	1	079000901
M	1	079000902
L	1	079000903
XL	1	079000904
XXL	1	079000905
XXXL	1	079000906
XXXXL	1	079000907

7901E

bermuda da lavoro in T/C canvas 260 g, grigio

CE

Beta EASY



Dimensione	Quantità	Articolo
XS	1	079010900
S	1	079010901
M	1	079010902
L	1	079010903
XL	1	079010904
XXL	1	079010905
XXXL	1	079010906
XXXXL	1	079010907

EASY

Beta

7903E

salopette da lavoro in T/C canvas 260 g, inserti in Oxford, grigio

CE

Beta ERSY



XS	1	079030900
S	1	079030901
M	1	079030902
L	1	079030903
XL	1	079030904
XXL	1	079030905
XXXL	1	079030906
XXXXL	1	079030907

7905E

tuta da lavoro in T/C canvas 260 g, inserti in Oxford, grigio

CE

Beta ERSY



XS	1	079050900
S	1	079050901
M	1	079050902
L	1	079050903
XL	1	079050904
XXL	1	079050905
XXXL	1	079050906
XXXXL	1	079050907

7904E

bomber da lavoro imbottito e foderato in T/C canvas 260 g, inserti in "Oxford", grigio

CE

Beta ERSY



XS	1	079040900
S	1	079040901
M	1	079040902
L	1	079040903
XL	1	079040904
XXL	1	079040905
XXXL	1	079040906
XXXXL	1	079040907

7907E

gilet multitasche da lavoro in T/C canvas 260 g, inserti in Oxford, grigio

CE

Beta ERSY



XS	1	079070900
S	1	079070901
M	1	079070902
L	1	079070903
XL	1	079070904
XXL	1	079070905
XXXL	1	079070906
XXXXL	1	079070907

7909E

giacca da lavoro in T/C canvas 260 g, inserti in Oxford, grigio

CE

Beta ERSY



XS	1	079090900
S	1	079090901
M	1	079090902
L	1	079090903
XL	1	079090904
XXL	1	079090905
XXXL	1	079090906
XXXXL	1	079090907

TOP LINE

7820

pantaloni da lavoro in T/C canvas ritorto 280 g, inserti in Cordura® e Reflex 3M Scotchlite™, nero/grigio

CE



XS	1	078200000
S	1	078200001
M	1	078200002
L	1	078200003
XL	1	078200004
XXL	1	078200005
XXXL	1	078200006
XXXXL	1	078200007

7821

bermuda da lavoro in T/C canvas ritorto 280 g, nero/grigio

CE



XS	1	078210000
S	1	078210001
M	1	078210002
L	1	078210003
XL	1	078210004
XXL	1	078210005
XXXL	1	078210006
XXXXL	1	078210007

7823

salopette da lavoro in T/C canvas ritorto 280 g, inserti in Cordura® e Reflex 3M Scotchlite™, nero/grigio

CE



XS	1	078230000
S	1	078230001
M	1	078230002
L	1	078230003
XL	1	078230004
XXL	1	078230005
XXXL	1	078230006
XXXXL	1	078230007

7825

tuta da lavoro in T/C canvas ritorto 280 g, inserti in Cordura® e Reflex 3M Scotchlite™, nero/grigio

CE



XS	1	078250000
S	1	078250001
M	1	078250002
L	1	078250003
XL	1	078250004
XXL	1	078250005
XXXL	1	078250006
XXXXL	1	078250007

7829

giacca da lavoro in T/C canvas ritorto 280 g, inserti in Cordura® e Reflex 3M Scotchlite™, nero/grigio

CE



XS	1	078290000
S	1	078290001
M	1	078290002
L	1	078290003
XL	1	078290004
XXL	1	078290005
XXXL	1	078290006
XXXXL	1	078290007

COTTON

7930P

pantaloni da lavoro in 100% cotone 260 g, grigio payne

CE



XS	1	079300100
S	1	079300101
M	1	079300102
L	1	079300103
XL	1	079300104
XXL	1	079300105
XXXL	1	079300106

7930IP

pantaloni da lavoro in 100% cotone 260 g, foderati in flanella di cotone 115 g, grigio payne

CE



XS	1	079300200
S	1	079300201
M	1	079300202
L	1	079300203
XL	1	079300204
XXL	1	079300205
XXXL	1	079300206

7931P

bermuda da lavoro in 100% cotone 260 g, grigio payne

CE



XS	1	079310100
S	1	079310101
M	1	079310102
L	1	079310103
XL	1	079310104
XXL	1	079310105
XXXL	1	079310106

Beta

7933P

salopette da lavoro in 100% cotone 260 g, grigio payne

CE



taglia	quantità	codice
XS	1	079330100
S	1	079330101
M	1	079330102
L	1	079330103
XL	1	079330104
XXL	1	079330105
XXXL	1	079330106

7935P

tuta da lavoro in 100% cotone 260 g, grigio payne

CE



taglia	quantità	codice
XS	1	079350100
S	1	079350101
M	1	079350102
L	1	079350103
XL	1	079350104
XXL	1	079350105
XXXL	1	079350106

7939P

giacca da lavoro in 100% cotone 260 g, grigio payne

CE



taglia	quantità	codice
XS	1	079390100
S	1	079390101
M	1	079390102
L	1	079390103
XL	1	079390104
XXL	1	079390105
XXXL	1	079390106

**7970**

pantaloni impermeabili in PVC Tricot, blu

CE



taglia	quantità	codice
XS	1	079700000
S	1	079700001
M	1	079700002
L	1	079700003
XL	1	079700004
XXL	1	079700005
XXXL	1	079700006

7971E

pantaloni impermeabili in poliestere spalmato PVC con cuciture termonastrate, blu

CE



taglia	quantità	codice
XS	1	079710000
S	1	079710001
M	1	079710002
L	1	079710003
XL	1	079710004
XXL	1	079710005
XXXL	1	079710006

7973

salopette impermeabile in PVC Tricot, blu

CE



taglia	quantità	codice
XS	1	079730000
S	1	079730001
M	1	079730002
L	1	079730003
XL	1	079730004
XXL	1	079730005
XXXL	1	079730006

7978E

giacca impermeabile in poliestere spalmato PVC
con cuciture termonastrate, blu

CE



Dimensione	Quantità	Articolo
XS	1	079780000
S	1	079780001
M	1	079780002
L	1	079780003
XL	1	079780004
XXL	1	079780005
XXXL	1	079780006

7979

giacca impermeabile in PVC Tricot, blu

CE



Dimensione	Quantità	Articolo
S	1	079790001
M	1	079790002
L	1	079790003
XL	1	079790004
XXL	1	079790005
XXXL	1	079790006

7991N

calzamaglia intima tecnica
in 100% poliestere 130 g, nero

CE



Dimensione	Quantità	Articolo
S	1	079910001
M	1	079910002
L	1	079910003
XL	1	079910004
XXL	1	079910005

7992N

maglia intima tecnica maniche lunghe
in 100% poliestere 130 g, nero

CE



Dimensione	Quantità	Articolo
S	1	079920001
M	1	079920002
L	1	079920003
XL	1	079920004
XXL	1	079920005

7993

calzamaglia intima tecnica
in 74% poliammide, 24% poliestere, 2% spandex, nero
Realizzata con tecnologia "seamless" che svolge un'azione contenitiva e favorisce i movimenti

CE



Dimensione	Quantità	Articolo
S	1	079930001
M/L	1	079930002
XL/XXL	1	079930004

7994

maglia intima tecnica maniche lunghe
in 75% nylon, 25% poliestere, nero/grigio
Realizzata con tecnologia "seamless" che svolge un'azione contenitiva e favorisce i movimenti



Dimensione	Quantità	Articolo
S	1	079940001
M/L	1	079940002
XL/XXL	1	079940004

UNDERWEAR



ACCESSORIES

7800G

coppia ginocchiere da lavoro



7800G

1 078000500

7981T

berretto in 100% acrilico
foderato in Thinsulate™ 40 g, nero

CE



7981T

10 079810111

7984

cintura da lavoro in 90% poliestere, 10%
cotone
taglia unica 130 cm accorciabile, larghezza
35 mm
grigio antracite



7984

1 079840130

7985

scaldacollo in micropile con regolatore, nero
utilizzabile anche come cappello

CE



7985

10 079850111

7190C

cuffie antirumore in PVC

• attenuazione da 15,5 dB a 63 Hz
sino a 37 dB a 8000 Hz

CE



EN 352-1

7190C

2 071900002

7195A

mascherine antipolvere FFP1

CE



7195A

10 071950004

Beta

7051MP

maschera di protezione
con visiera in policarbonato

CE



EN166

7051MP

5 070510001

7061TC

occhiali di protezione con lenti in policarbonato
trasparente

CE

EASY



7061TC

1 070610001

7076BC

occhiali di protezione con lenti in policarbonato
trasparente

CE

SPORT



EN166F-1F
EN172
UV 5-3.1

7076BC

1 070760009

7076BD

occhiali di protezione con lenti in policarbonato
scuro

CE

SPORT



EN166F-1F
EN170
UV 5-2.5

7076BD

1 070760019

7076BP

occhiali di protezione con lenti in policarbonato
polarizzato scuro

CE

SPORT



EN12311

7076BP

1 070760029

7076BU

occhiali per la ricerca di fughe con lampada
UV

CE



EN12312-1

7076BU

1 070760039

7093BC

occhiali di protezione con lenti in policarbonato
trasparente

CE

IMPACT



EN166F-1F
EN170
UV400

7093BC

1 070930009

7093BD

occhiali di protezione con lenti in policarbonato scuro

CE
IMPACT



EN166F-1F
EN172
UV5-2.5

7093BD CHF 30.50 1 070930019

C62M/W

espositore a manichino



185
cm

65 cm

C62M/W CHF 474.00 1 062000360

Beta

C62EV/CP

espositore per calzature, 15 posizioni



1700 mm

460 mm

C62EV/CP CHF 230.00 1 062000401

C63 E/W

espositore abbigliamento e calzature



2250 mm

515 mm

1010 mm

C63 E/W CHF 1,215.00 1 063000010

C63 G/C

gondola espositiva calzature

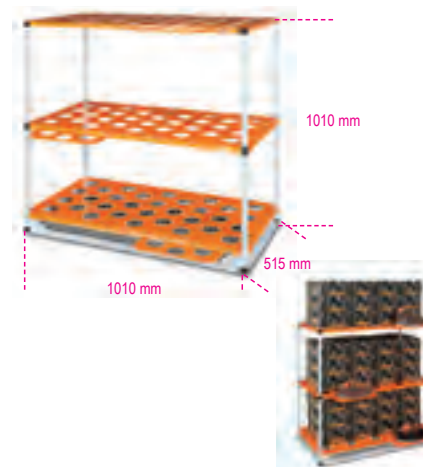

1010 mm

515 mm

C63 G/C CHF 896.00 1 063000020

6200AP/S10

set da 10 grucce



6200AP/S10 CHF 41.00 1 062000331

Beta

Robur



Dal 1930, Robur produce linee di accessori per funi allineandosi alla riconosciuta qualità di Beta Utensili, di cui è complemento produttivo.

Esperienza, organizzazione e tecnologia sono i requisiti di un continuo sviluppo determinato dall'attenzione alle esigenze del mercato.

Dal 1984, Robur ha sede in un moderno stabilimento a Sulmona.

NEW LOGO 

Confezioni speciali per libero servizio a pagina 449

 **Beta**

GUIDA ALLA LETTURA

CARICHI

WLL: carico massimo di esercizio (per accessori di sollevamento)

WFL: forza limite di lavoro (per accessori non destinati al sollevamento)

BF: forza massima raggiunta dall'articolo durante la prova di trazione statica

LC: tensione di ancoraggio

8041 numero articolo
golfari maschio per sollevamento, acciaio legato ad alta resistenza



novità 2017

misura

numero utensili nella confezione

numero codice

Ø mm	mm	E mm	WLL kg	
* M8	1,25	13	600	
* M10	1,5	17	800	10 080410208
* M12	1,75	20,5	1300	6 080410210
* M16	2	27	3200	4 080410212
* M20	2,5	30	4800	2 080410216
* M24	3	36	6500	2 080410220
* M30	3,5	45	9500	2 080410224
				1 080410230

• 4 DIVERSE TIPOLOGIE DI CERTIFICAZIONE

• 140 SPECIFICHE TECNICHE COSTANTEMENTE AGGIORNATE

Articolo	Rapporto di Prova 2.2 (UNI EN 10204)	Certificato di Controllo 3.1 (UNI EN 10204)	Certificato del fabbricante	Dichiarazione di Conformità CE	Articolo	Rapporto di Prova 2.2 (UNI EN 10204)	Certificato di Controllo 3.1 (UNI EN 10204)	Certificato del fabbricante	Dichiarazione di Conformità CE	Articolo	Rapporto di Prova 2.2 (UNI EN 10204)	Certificato di Controllo 3.1 (UNI EN 10204)	Certificato del fabbricante	Dichiarazione di Conformità CE
8001Z	✓	✓		✓	8080	✓				8381SL	✓			
8001TZ	✓	✓		✓	8085	✓	✓		✓	8381SP	✓			
8002ZD	✓				8086	✓	✓		✓	8383C	✓			
8003ZD	✓				8090	✓	✓		✓	8383P	✓			
8004ND	✓				8090F	✓	✓		✓	8515V	✓			
8005Z	✓			✓	8091			✓	✓	8515Z	✓			
8005TZ	✓			✓	8092			✓	✓	8531	✓			
8006Z	✓			✓	8094			✓	✓	8532	✓			
8007Z	✓			✓	8096			✓	✓	8535	✓			
8008N	✓			✓	8097			✓	✓	8201T	✓			
8009FD	✓				8098			✓	✓	8205	✓			
8009Z	✓			✓	8100	✓	✓		✓	8206	✓			
8009TZ	✓			✓	8105	✓				8207	✓			
8010Z	✓			✓	8109	✓				8209	✓			
8016	✓			✓	8114	✓				8210	✓			
8016DA	✓			✓	8116	✓				8216	✓			✓
8016DF	✓			✓	8150	✓		✓	✓	8220	✓			
8016FR	✓				8153	✓		✓	✓	8225	✓			
8016U	✓		✓	✓	8156	✓		✓	✓	8227	✓			
8018E	✓				8157	✓		✓	✓	8228	✓			
8018T	✓				8158	✓		✓	✓	8240	✓			
8020	✓				8159	✓		✓	✓	8240F	✓	✓		✓
8021	✓				8160	✓		✓	✓	8242	✓			
8025	✓	✓		✓	8161	✓		✓	✓	8242F	✓	✓		✓
8026A	✓	✓		✓	8166	✓				8248	✓			
8026R	✓	✓		✓	8170	✓		✓	✓	8249	✓			
8028	✓	✓		✓	8173	✓		✓	✓	8249G	✓			
8029	✓	✓		✓	8176	✓		✓	✓	8250	✓			
8029R	✓	✓		✓	8177	✓		✓	✓	8264	✓			
8031R	✓	✓		✓	8178	✓		✓	✓	8267	✓			
8032	✓	✓		✓	8180	✓				8272	✓			
8040EN	✓	✓		✓	8181	✓				8273	✓			
8040EZ	✓	✓		✓	8182	✓				8274	✓			
8042EN	✓	✓		✓	8182A	✓				8274A	✓			
8042EZ	✓	✓		✓	8182E	✓				8274G	✓			
8044	✓	✓		✓	8182S	✓				8276	✓			
8048	✓				8185	✓				8276G	✓			
8049	✓	✓		✓	8186	✓				8278	✓			
8051S	✓	✓		✓	8187	✓				8280	✓			
8052	✓	✓		✓	8188C	✓				8282	✓			
8055S	✓	✓		✓	8188CG/25	✓				8284	✓			
8057	✓	✓		✓	8188F	✓				8285	✓			
8058	✓	✓		✓	8188F/35	✓				8286	✓			
8060	✓	✓		✓	8188FG2	✓				8287	✓			
8061F	✓	✓		✓	8188FG3	✓				8290	✓			
8062	✓	✓		✓	8302Z	✓				8293	✓			
8064S	✓	✓		✓	8303Z	✓				8297C	✓			
8065SC	✓	✓		✓	8317DZ	✓				8297F	✓			
8074	✓				8317SZ	✓				8381SX	✓			

8001Z

canaule per tenditori
zincate



DATI TECNICI

- coefficiente di sicurezza: 4
- codice lotto di fabbricazione

ANALISI DI LABORATORIO

- analisi chimica
- test di trazione

CERTIFICATI DISPONIBILI

- Specifica Prodotto
- Rapporto di Prova tipo 2.2 UNI EN10204
- Certificato di Controllo tipo 3.1 UNI EN10204
- Dichiarazione di Conformità CE

Ø mm	Ø "	L mm	WFL kg	CHF		
M5	3/16	80	115	1.26	100	080010105
M6	1/4	80	160	1.41	100	080010106
M8	5/16	105	300	2.09	25	080010108
M10	3/8	125	470	2.65	20	080010110
M11	7/16	135	580	3.35	15	080010111
M12	1/2	140	690	3.60	20	080010112
M14	9/16	170	940	5.20	15	080010114
M16	5/8	190	1290	6.90	15	080010116
M18	11/16	205	1660	11.00	10	080010118
M20	3/4	220	2130	12.40	10	080010120
M22	7/8	240	2630	15.90	8	080010122
M24	1"	260	3060	19.20	5	080010124
M27	1 1/8	270	4000	30.50	1	080010127
M30	1 3/16	280	4860	38.50	1	080010130
M33	1 1/4	290	6040	41.00	1	080010133
M36*	1 3/8	300	6500	53.50	1	080010198
M39*	1 1/2	300	7900	65.00	1	080010199

* Filettatura Whitworth fino ad esaurimento scorte.
Nuovi lotti con filettatura passo metrico

8001TZ

canaule a tubo per tenditori
zincate



DIN 1478

DATI TECNICI

- coefficiente di sicurezza: 4
- codice lotto di fabbricazione

ANALISI DI LABORATORIO

- analisi chimica
- test di trazione

CERTIFICATI DISPONIBILI

- Specifica Prodotto
- Rapporto di Prova tipo 2.2 UNI EN10204
- Certificato di Controllo tipo 3.1 UNI EN10204
- Dichiarazione di Conformità CE

Ø mm	Ø "	L mm	WFL kg	CHF		
M12	1/2	125	690	5.25	10	080010512
M16	5/8	170	1290	8.70	5	080010516
M20	3/4	200	2130	12.00	5	080010520
M24	1"	255	3060	20.90	3	080010524
* M27	1 1/8	255	4000	28.00	1	080010527
M30	1 3/16	255	4860	34.00	1	080010530
M36	1 3/8	295	6500	57.50	1	080010536

* misure non contemplate nella norma.



8002ZD

anelli per tenditori,
filettatura destra, zincati



DATI TECNICI

- coefficiente di sicurezza: 4

ANALISI DI LABORATORIO

- analisi chimica
- test di trazione

CERTIFICATI DISPONIBILI

- Specifica Prodotto
- Rapporto di Prova tipo 2.2 UNI EN10204

Ø mm	Ø "	E mm	WFL kg	CHF		
M5	3/16	37	115	0.46	200	080020105
M6	1/4	40	160	0.54	150	080020106
M8	5/16	52	300	0.80	100	080020108
M10	3/8	60	470	1.26	100	080020110
M11	7/16	65	580	1.72	1	080020111
M12	1/2	72	690	2.24	50	080020112
M14	9/16	85	940	2.82	1	080020114
M16	5/8	95	1290	4.60	1	080020116
M18	11/16	103	1660	6.50	1	080020118
M20	3/4	110	2130	7.45	1	080020120
M22	7/8	120	2630	10.80	1	080020122
M24	1"	130	3060	13.70	1	080020124
M27	1 1/8	135	4000	19.30	1	080020127
M30	1 3/16	140	4860	22.50	1	080020130
M33	1 1/4	148	6040	27.50	1	080020133
M36*	1 3/8	150	6500	33.50	1	080020198
M39*	1 1/2	150	7900	38.50	1	080020199

* Filettatura Whitworth fino ad esaurimento scorte.
Nuovi lotti con filettatura passo metrico.

filetto sinistrorso

Ø mm	Ø "	E mm	WFL kg	CHF		
M5	3/16	37	115	0.46	1	080020305
M6	1/4	40	160	0.54	1	080020306
M8	5/16	52	300	0.80	1	080020308
M10	3/8	60	470	1.26	1	080020310
M11	7/16	65	580	1.72	1	080020311
M12	1/2	72	690	2.24	1	080020312
M14	9/16	85	940	2.82	1	080020314
M16	5/8	95	1290	4.60	1	080020316
M18	11/16	103	1660	6.50	1	080020318
M20	3/4	110	2130	7.45	1	080020320
M22	7/8	120	2630	10.80	1	080020322
M24	1"	130	3060	13.70	1	080020324
M27	1 1/8	135	4000	19.30	1	080020327
M30	1 3/16	140	4860	22.50	1	080020330
M33	1 1/4	148	6040	27.50	1	080020333
M36*	1 3/8	150	6500	33.50	1	080020398
M39*	1 1/2	150	7900	38.50	1	080020399

8004ND

tronchi per tenditori
destri - neri



DATI TECNICI

- coefficiente di sicurezza: 4

ANALISI DI LABORATORIO

- analisi chimica
- test di trazione

CERTIFICATI DISPONIBILI

- Specifica Prodotto
- Rapporto di Prova tipo 2.2 UNI EN10204

Ø mm	Ø "	E mm	WFL kg	CHF		
M5	3/16	40	115	0.51	1	080040005
M6	1/4	44	160	0.58	1	080040006
M8	5/16	53	300	0.70	1	080040008
M10	3/8	63	470	0.90	1	080040010
M12	1/2	70	690	1.60	1	080040012
M14	9/16	85	940	2.11	1	080040014
M16	5/8	95	1290	2.88	1	080040016
M18	11/16	103	1660	4.00	1	080040018
M20	3/4	110	2130	5.10	1	080040020
M22	7/8	120	2630	6.20	1	080040022
M24	1"	130	3060	8.60	1	080040024
M27	1 1/8	135	4000	14.00	1	080040027
M30	1 3/16	140	4860	17.30	1	080040030
M33	1 1/4	150	6040	17.70	1	080040033
M36*	1 3/8	150	6500	23.10	1	080040098
M39*	1 1/2	150	7900	25.00	1	080040099

* Filettatura Whitworth fino ad esaurimento scorte.
Nuovi lotti con filettatura passo metrico

filetto sinistrorso

Ø mm	Ø "	E mm	WFL kg	CHF		
M5	3/16	40	115	0.51	1	080040105
M6	1/4	44	160	0.58	1	080040106
M8	5/16	53	300	0.70	1	080040108
M10	3/8	63	470	0.90	1	080040110
M12	1/2	70	690	1.60	1	080040112
M14	9/16	85	940	2.11	1	080040114
M16	5/8	95	1290	2.88	1	080040116
M18	11/16	103	1660	4.00	1	080040118
M20	3/4	110	2130	5.10	1	080040120
M22	7/8	120	2630	6.20	1	080040122
M24	1"	130	3060	8.60	1	080040124
M27	1 1/8	135	4000	14.00	1	080040127
M30	1 3/16	140	4860	17.30	1	080040130
M33	1 1/4	150	6040	17.70	1	080040133
M36*	1 3/8	150	6500	23.10	1	080040198
M39*	1 1/2	150	7900	25.00	1	080040199



8003ZD

ganci per tenditori,
filettatura destra, zincati

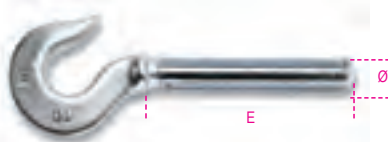

DATI TECNICI

- coefficiente di sicurezza: 4
- ANALISI DI LABORATORIO
- analisi chimica • test di trazione
- CERTIFICATI DISPONIBILI
- Specifica Prodotto
- Rapporto di Prova tipo 2.2 UNI EN10204

Ø mm	Ø "	E mm	WFL kg	CHF		
M5	3/16	40	25	0.64	150	080030105
M6	1/4	40	45	0.73	120	080030106
M8	5/16	52	95	0.99	100	080030108
M10	3/8	60	140	1.72	70	080030110
M11	7/16	65	165	2.36	1	080030111
M12	1/2	70	300	2.95	30	080030112
M14	9/16	85	420	4.50	1	080030114
M16	5/8	95	570	6.80	1	080030116
M18	11/16	103	700	9.00	1	080030118
M20	3/4	110	900	12.30	1	080030120
M22	7/8	120	1100	16.00	1	080030122
M24	1"	130	1300	25.00	1	080030124
M27	1 1/8	135	2300	29.00	1	080030127

filetto sinistrorso

Ø mm	"	WFL kg	E mm	CHF		
M5	3/16	40	25	0.64	1	080030305
M6	1/4	40	45	0.73	1	080030306
M8	5/16	52	95	0.99	1	080030308
M10	3/8	60	140	1.72	1	080030310
M11	7/16	65	165	2.36	1	080030311
M12	1/2	70	300	2.95	1	080030312
M14	9/16	85	420	4.50	1	080030314
M16	5/8	95	570	6.80	1	080030316
M18	11/16	103	700	9.00	1	080030318
M20	3/4	110	900	12.30	1	080030320
M22	7/8	120	1100	16.00	1	080030322
M24	1"	130	1300	25.00	1	080030324
M27	1 1/8	135	2300	29.00	1	080030327

8009FD

forcelle per tenditori
destre - zincate

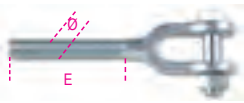

DATI TECNICI

- coefficiente di sicurezza: 4
- ANALISI DI LABORATORIO
- analisi chimica
- test di trazione
- CERTIFICATI DISPONIBILI
- Specifica Prodotto
- Rapporto di Prova tipo 2.2 UNI EN10204

Ø mm	Ø "	E mm	WFL kg	CHF		
M8	5/16	53	300	5.50	1	080090208
M10	3/8	63	470	6.40	1	080090210
M12	1/2	70	690	8.30	1	080090212
M14	9/16	85	940	11.10	1	080090214
M16	5/8	95	1290	12.60	1	080090216
M18	11/16	103	1660	17.30	1	080090218
M20	3/4	110	2130	18.00	1	080090220
M22	7/8	120	2630	25.00	1	080090222
M24	1"	130	3060	31.00	1	080090224
M27	1 1/8	135	4000	50.50	1	080090227
M30	1 3/16	140	4860	64.00	1	080090230

filetto sinistrorso

Ø mm	"	E mm	WFL kg	CHF		
M8	5/16	53	300	5.50	1	080090408
M10	3/8	63	470	6.40	1	080090410
M12	1/2	70	690	8.30	1	080090412
M14	9/16	85	940	11.10	1	080090414
M16	5/8	95	1290	12.60	1	080090416

Ø mm	"	E mm	WFL kg	CHF		
M18	11/16	103	1660	17.30	1	080090418
M20	3/4	110	2130	18.00	1	080090420
M22	7/8	120	2630	25.00	1	080090422
M24	1"	130	3060	31.00	1	080090424
M27	1 1/8	135	4000	50.50	1	080090427
M30	1 3/16	140	4860	64.00	1	080090430

8005Z

tenditori a due occhi
zincati

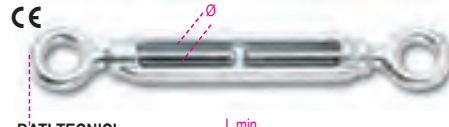

DATI TECNICI

- coefficiente di sicurezza: 4
- ANALISI DI LABORATORIO
- analisi chimica
- test di trazione
- CERTIFICATI DISPONIBILI
- Specifica Prodotto
- Rapporto di Prova tipo 2.2 UNI EN10204
- Dichiarazione di Conformità CE

Ø mm	Ø "	L min mm	WFL kg	CHF		
M5	3/16	118	115	2.11	400	080050105
M6	1/4	130	160	2.50	300	080050106
M8	5/16	158	300	3.80	200	080050108
M10	3/8	192	470	5.30	100	080050110
M11	7/16	206	580	6.90	80	080050111
M12	1/2	226	690	7.80	60	080050112
M14	9/16	256	940	10.90	15	080050114
M16	5/8	290	1290	16.40	10	080050116
M18	11/16	358	1660	25.50	1	080050118
M20	3/4	358	2130	28.00	1	080050120
M22	7/8	400	2630	37.00	1	080050122
M24	1"	436	3060	46.50	1	080050124
M27	1 1/8	474	4000	68.00	1	080050125
M30	1 3/16	498	4860	82.00	1	080050130
M33	1 1/4	516	6040	93.00	1	080050126
M36*	1 3/8	532	6500	118.00	1	080050136
M39*	1 1/2	544	7900	140.00	1	080050139

* Filettatura Whitworth fino ad esaurimento scorte.
Nuovi lotti con filettatura passo metrico

confezioni speciali

Ø mm	"		CHF		
M5	3/16	30	63.50	1	080050705
M6	1/4	30	75.00	1	080050706
M8	5/16	20	76.00	1	080050708
M10	3/8	15	79.50	1	080050710
M11	7/16	15	103.50	1	080050711
M12	1/2	15	117.00	1	080050712

8005TZ

tenditori a due occhi FORGIATI A CALDO
canaula a tubo DIN 1478
zincati



DATI TECNICI

- coefficiente di sicurezza: 4
- ANALISI DI LABORATORIO
- analisi chimica
- test di trazione
- CERTIFICATI DISPONIBILI
- Specifica Prodotto
- Rapporto di Prova tipo 2.2 UNI EN10204
- Dichiarazione di Conformità CE

Ø mm	Ø "	WFL kg	CHF		
M12	1/2	690	11.50	15	080050512
M16	5/8	1290	18.00	1	080050516
M20	3/4	2130	28.50	1	080050520
M24	1"	3060	48.50	1	080050524
M30	1.3/16	4860	79.00	1	080050530

8006Z

tenditori ad occhio e gancio
zincati

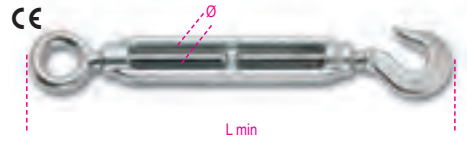

DATI TECNICI

- coefficiente di sicurezza: 4
- ANALISI DI LABORATORIO
- analisi chimica
- test di trazione
- CERTIFICATI DISPONIBILI
- Specifica Prodotto
- Rapporto di Prova tipo 2.2 UNI EN10204
- Dichiarazione di Conformità CE

Ø mm	Ø "	L min mm	WFL kg	CHF		
M5	3/16	121	25	2.36	400	080060105
M6	1/4	132	45	2.62	250	080060106
M8	5/16	170	95	3.85	180	080060108
M10	3/8	204	140	5.50	100	080060110
M11	7/16	221	165	7.40	70	080060111
M12	1/2	244	300	8.60	15	080060112
M14	9/16	284	420	12.30	10	080060114
M16	5/8	322	570	18.50	1	080060116
M18	11/16	373	700	27.50	1	080060118
M20	3/4	391	900	32.50	1	080060120
M22	7/8	433	1100	43.00	1	080060122
M24	1"	470	1300	57.50	1	080060124
M27	1 1/8	503	2300	77.00	1	080060127

confezioni speciali

Ø mm	"		CHF		
M5	3/16	30	71.00	1	080060705
M6	1/4	30	78.50	1	080060706
M8	5/16	20	77.00	1	080060708
M10	3/8	15	82.50	1	080060710
M11	7/16	15	111.00	1	080060711

8007Z

tenditori a due ganci
zincati

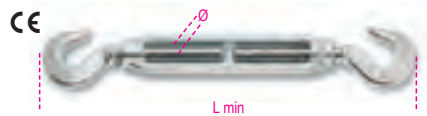

DATI TECNICI

- coefficiente di sicurezza: 4
- ANALISI DI LABORATORIO
- analisi chimica
- test di trazione
- CERTIFICATI DISPONIBILI
- Specifica Prodotto
- Rapporto di Prova tipo 2.2 UNI EN10204
- Dichiarazione di Conformità CE

Ø mm	Ø "	L min mm	WFL kg	CHF		
M5	3/16	124	25	2.56	30	080070105
M6	1/4	134	45	2.88	30	080070106
M8	5/16	181	95	4.00	20	080070108
M10	3/8	211	140	5.90	15	080070110
M11	7/16	231	165	7.90	15	080070111
M12	1/2	262	300	9.40	15	080070112
M14	9/16	312	420	14.10	1	080070114
M16	5/8	354	570	20.50	1	080070116
M18	11/16	388	700	29.00	1	080070118
M20	3/4	424	900	37.00	1	080070120
M22	7/8	466	1100	47.50	1	080070122
M24	1"	504	1300	67.00	1	080070124
M27	1 1/8	532	2300	87.00	1	080070127

8008N

tenditori a due tronchi
neri

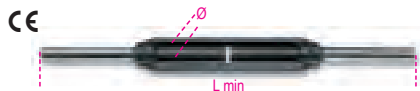

DATI TECNICI

- coefficiente di sicurezza: 4
- ANALISI DI LABORATORIO
- analisi chimica
- test di trazione
- CERTIFICATI DISPONIBILI
- Specifica Prodotto
- Rapporto di Prova tipo 2.2 UNI EN10204
- Dichiarazione di Conformità CE

Ø mm	Ø "	L min mm	WFL kg	CHF		
M5	3/16	160	115	2.18	30	080080205
M6	1/4	180	160	2.30	30	080080206
M8	5/16	210	300	3.20	20	080080208
M10	3/8	250	470	4.30	15	080080210
M12	1/2	280	690	5.90	15	080080212
M14	9/16	340	940	8.60	5	080080214
M16	5/8	380	1290	11.70	5	080080216
M18	1 1/16	410	1660	17.70	3	080080218
M20	3/4	440	2130	20.60	3	080080220
M22	7/8	480	2630	28.00	2	080080222
M24	1"	520	3060	32.00	2	080080224
M27	1 1/8	560	4000	53.00	1	080080227
M30	1 3/16	560	4860	66.00	1	080080230
M33	1 1/4	600	6040	68.00	1	080080233
M36*	1 3/8	600	6500	86.00	1	080080236
M39*	1 1/2	600	7900	102.00	1	080080239

* filettatura Whitworth fino ad esaurimento scorte.
Nuovi lotti con filettatura passo metrico

8009Z

tenditori a due forcelle
zincati

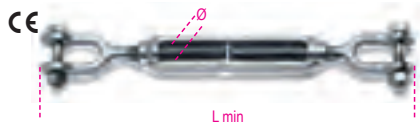

DATI TECNICI

- coefficiente di sicurezza: 4
- ANALISI DI LABORATORIO
- analisi chimica
- test di trazione
- CERTIFICATI DISPONIBILI
- Specifica Prodotto
- Rapporto di Prova tipo 2.2 UNI EN10204
- Dichiarazione di Conformità CE

Ø mm	Ø "	L min mm	WFL kg	CHF		
M8	5/16	192	300	13.20	15	080090008
M10	3/8	234	470	15.20	15	080090010
M12	1/2	274	690	20.80	15	080090012
M14	9/16	342	940	29.00	1	080090014
M16	5/8	372	1290	33.50	1	080090016
M18	1 1/16	406	1660	48.00	1	080090018
M20	3/4	406	2130	50.50	1	080090020
M22	7/8	466	2630	69.00	1	080090022
M24	1"	486	3060	79.00	1	080090024
M27	1 1/8	510	4000	132.00	1	080090027
M30	1 3/16	566	4860	165.00	1	080090030

8009TZ

tenditori a due forcelle
canaula a tubo DIN 1478
zincati



DATI TECNICI

- coefficiente di sicurezza: 4
- ANALISI DI LABORATORIO
- analisi chimica
- test di trazione
- CERTIFICATI DISPONIBILI
- Specifica Prodotto
- Rapporto di Prova tipo 2.2 UNI EN10204
- Dichiarazione di Conformità CE

Ø mm	Ø "	WFL kg	CHF		
M12	1/2	690	17.80	10	080090512
M16	5/8	1290	30.50	1	080090516
M20	3/4	2130	45.50	1	080090520
M24	1	3060	70.00	1	080090524
M30	1.3/16	4860	132.00	1	080090530

8010Z

tenditori ad occhio e forcella
zincati

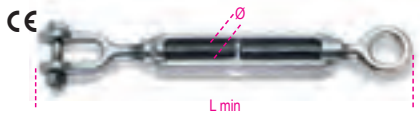

DATI TECNICI

- coefficiente di sicurezza: 4
- ANALISI DI LABORATORIO
- analisi chimica
- test di trazione
- CERTIFICATI DISPONIBILI
- Specifica Prodotto
- Rapporto di Prova tipo 2.2 UNI EN10204
- Dichiarazione di Conformità CE

Ø mm	Ø "	L min mm	WFL kg	CHF		
M8	5/16	175	300	8.00	20	080100008
M10	3/8	215	470	9.80	15	080100010
M12	1/2	250	690	13.80	10	080100012
M14	9/16	299	940	19.00	10	080100014
M16	5/8	331	1290	25.00	1	080100016
M18	1 1/16	382	1660	36.50	1	080100018
M20	3/4	382	2130	40.50	1	080100020
M22	7/8	433	2630	55.00	1	080100022
M24	1"	461	3060	64.00	1	080100024
M27	1 1/8	492	4000	98.00	1	080100027
M30	1 3/16	529	4860	125.00	1	080100030



8105

tenditori a due occhi ad alta resistenza
zincati a caldo



DATI TECNICI

- coefficiente di sicurezza: 5
- trattamento termico canaule: normalizzazione
- trattamento termico anelli: bonifica
- codice lotto di fabbricazione
- ANALISI DI LABORATORIO
- analisi chimica
- test di trazione
- CERTIFICATI DISPONIBILI
- Specifica Prodotto
- Rapporto di Prova tipo 2.2 UNI EN10204
- Certificato di Controllo tipo 3.1 UNI EN10204
- Dichiarazione di Conformità CE

ØxL "	≈ mm	WFL kg	CHF		
3/8x6	M10x150	540	12.10	5	081050010
1/2x9	M12x230	1000	25.50	5	081050012
5/8x9	M16x230	1590	38.50	2	081050016
3/4x9	M20x230	2360	57.50	2	081050020
7/8x12	M22x300	3270	97.00	1	081050022
1"x6	M24x150	4540	102.00	1	081050024
1"x12	M24x300	4540	146.00	1	081050025
1 1/4x12	M33x300	6890	248.00	1	081050031

Altre misure disponibili a richiesta

8109

tenditori a due forcelle ad alta resistenza
zincati a caldo

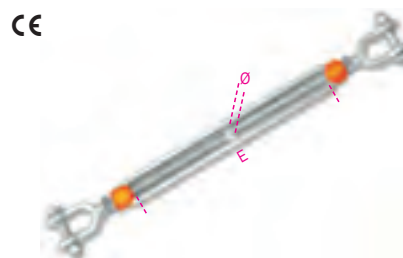

DATI TECNICI

- coefficiente di sicurezza: 5
- trattamento termico canaule: normalizzazione
- trattamento termico anelli: bonifica
- codice lotto di fabbricazione
- ANALISI DI LABORATORIO
- analisi chimica
- test di trazione
- CERTIFICATI DISPONIBILI
- Specifica Prodotto
- Rapporto di Prova tipo 2.2 UNI EN10204
- Certificato di Controllo tipo 3.1 UNI EN10204
- Dichiarazione di Conformità CE

ØxL "	≈ mm	WFL kg	CHF		
3/8x6	M10x150	540	15.70	5	081090010
1/2x9	M12x230	1000	31.00	5	081090012
5/8x9	M16x230	1590	56.50	2	081090016
3/4x9	M20x230	2360	77.00	2	081090020
7/8x12	M22x300	3270	129.00	1	081090022
1"x6	M24x150	4540	129.00	1	081090024
1"x12	M24x300	4540	183.00	1	081090025
1 1/4x12	M33x300	6890	298.00	1	081090031
1 1/4x24	M33x610	6890	461.00	1	081090033

Altre misure disponibili a richiesta

8016U

morsetti EN 13411-5, tipo A
corpo in ghisa malleabile
zincati

CE

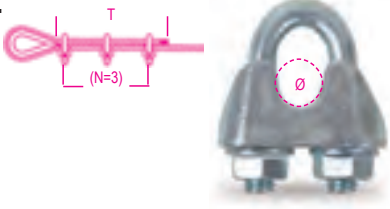

EN 13411-5

DATI TECNICI

- codice di identificazione
- ANALISI DI LABORATORIO**
- analisi chimica
- test coppia di serraggio
- CERTIFICATI DISPONIBILI**
- Specifica Prodotto
- Rapporto di Prova tipo 2.2 UNI EN10204
- Certificato del Fabricante UNI EN13411-5
- Dichiarazione di Conformità CE

Ø mm	Ø "	N x T	Nm	CHF		
5	3/16	3x156	2,0	0.58	300	080160605
6,5	1/4	3x192	3,5	0.90	150	080160606
8	5/16	4x320	6	1.60	70	080160608
10	3/8	4x320	9	1.86	60	080160610
12	1/2	4x384	20	3.25	25	080160612
14	9/16	4x448	33	4.30	15	080160614
16	5/8	4x512	49	6.15	10	080160616
19	3/4	4x512	68	6.90	10	080160619
22	7/8	5x680	107	9.40	10	080160622
26	1"	5x760	147	15.70	5	080160626
30	1 1/8	6x984	212	19.70	5	080160630
34	1 1/4	6x1080	296	26.50	5	080160634
40	1 1/2	6x1176	363	34.00	5	080160640

8016

morsetti in acciaio
zincati

CE

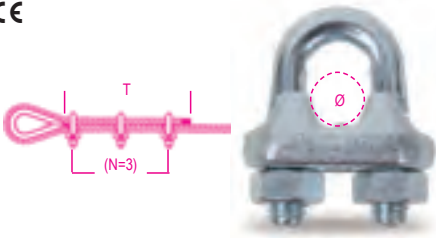

ANALISI DI LABORATORIO

- analisi chimica
- test coppia di serraggio
- CERTIFICATI DISPONIBILI**
- Specifica Prodotto
- Rapporto di Prova tipo 2.2 UNI EN10204
- Certificato di Conformità CE

Ø mm	Ø "	N x T	Nm	CHF		
3	1/8	3x80	1,53	0.54	500	080160003
5	3/16	3x110	3,02	0.74	300	080160005
6	1/4	3x120	5,19	0.80	200	080160006
8	5/16	5x210	5,19	1.02	150	080160008
10	3/8	5x240	12,54	1.47	70	080160010
11	7/16	5x260	12,54	1.60	70	080160011
12-13	1/2	5x300	24,76	2.14	40	080160013
14	9/16	5x295	24,76	2.35	35	080160014
16	5/8	5x335	24,76	2.79	30	080160016
18	11/16	5x380	42,42	3.80	30	080160018
20	3/4	5x540	42,42	4.10	30	080160020
22	7/8	7x595	42,42	4.70	25	080160022
24-26	1"	7x700	67,56	6.50	15	080160026
28	1 1/16	8x840	67,56	8.00	5	080160028
30-32	1 1/8	8x990	67,56	8.15	5	080160030
34-36	1 1/4	8x1155	105,80	10.70	4	080160034
38-40	1 1/2	8x1320	105,80	14.40	2	080160040
48-50	2"	8x1500	206	21.10	1	080160050

confezioni speciali

Ø mm	"		CHF	
3	1/8	100	54.00	1 080160703
5	3/16	50	37.00	1 080160705
6	1/4	50	40.00	1 080160706
8	5/16	30	30.50	1 080160708
10	3/8	30	44.00	1 080160710
11	7/16	25	40.00	1 080160711
12-13	1/2	15	32.00	1 080160713

8016DA

morsetti in acciaio, dado alto
zincati

CE

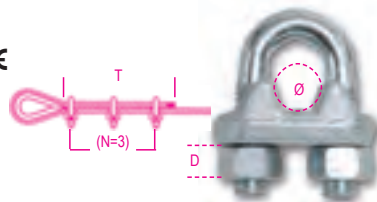

ANALISI DI LABORATORIO

- analisi chimica
- test coppia di serraggio
- CERTIFICATI DISPONIBILI**
- Specifica Prodotto
- Rapporto di Prova tipo 2.2 UNI EN10204
- Certificato di Conformità CE

Ø mm	N x T	Nm	D mm	CHF		
5	3x110	3,02	5	0.93	300	080160093
6	3x120	5,19	6	1.02	200	080160092
8	5x210	5,19	6	1.24	150	080160098
10	5x240	12,54	8	1.82	70	080160096

8016DF

morsetti in acciaio, dado flangiato
zincati

CE

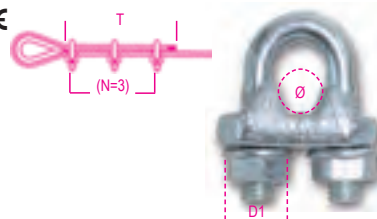

ANALISI DI LABORATORIO

- analisi chimica
- test coppia di serraggio
- CERTIFICATI DISPONIBILI**
- Specifica Prodotto
- Rapporto di Prova tipo 2.2 UNI EN10204
- Certificato di Conformità CE

Ø mm	N x T	Nm	D1 mm	CHF		
6	3x120	5,19	14,2	1.00	200	080160066
8	5x210	5,19	14,2	1.19	150	080160068
10	5x240	12,54	17,9	1.82	70	080160070

8016FR

morsetti in acciaio,
corpo stampato a freddo
zincati

CE

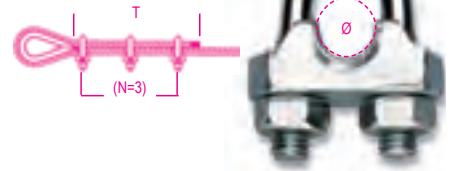

ANALISI DI LABORATORIO

- analisi chimica
- CERTIFICATI DISPONIBILI**
- Specifica Prodotto
- Rapporto di Prova tipo 2.2 UNI EN10204
- Certificato di Conformità CE

Ø mm	Ø "	N x T	Nm	CHF		
3	1/8	3x80	1,25	0.51	500	080160253
5	3/16	3x110	2,46	0.64	300	080160255
6	1/4	3x120	4,24	0.77	200	080160256
8	5/16	5x210	4,24	0.92	150	080160258
10	3/8	5x240	10,20	1.34	70	080160260
12-13	1/2	5x300	20,11	1.92	40	080160263

8018E

morsetti tipo ENEL, dado alto
corpo in acciaio zincato a caldo
cavallotti e dadi zincati e sigillati



ANALISI DI LABORATORIO

- analisi chimica
- CERTIFICATI DISPONIBILI**
- Specifica Prodotto
- Rapporto di Prova tipo 2.2 UNI EN10204

Ø mm	A mm	L mm	Nm	CHF		
4÷6	M6	34	4,24	1.12	100	080180001

8018T

morsetti tipo TELECOM,
corpo in ghisa malleabile
zincato a caldo



RUM-MU-21:1980

ANALISI DI LABORATORIO

- analisi chimica
- CERTIFICATI DISPONIBILI**
- Specifica Prodotto
- Rapporto di Prova tipo 2.2 UNI EN10204

Ø mm	A mm	L mm	Nm	CHF		
8÷10	M8	42	10,20	1.19	200	080180003

8317DZ

morsetti duplex
zincati

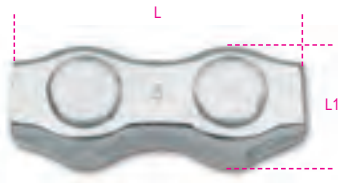

CERTIFICATI DISPONIBILI

• Rapporto di Prova tipo 2.2 UNI EN10204

Ø mm	L mm	L1 mm	CHF	📄	🏭
2	30	14	0.28	50	083170002
3	35	15	0.34	50	083170003
4	40	18	0.43	50	083170004
5	50	21	0.60	25	083170005
6	60	25	0.80	20	083170006
8	76	33	1.60	10	083170008
10	95	37	2.43	10	083170010

8317SZ

morsetti simplex
zincati

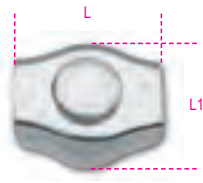

CERTIFICATI DISPONIBILI

• Rapporto di Prova tipo 2.2 UNI EN10204

Ø mm	L mm	L1 mm	CHF	📄	🏭
2	15	14	0.21	100	083170102
3	18	16	0.21	100	083170103
4	20	19	0.30	100	083170104
5	24	23	0.34	50	083170105
6	30	27	0.41	30	083170106
8	36	34	0.82	20	083170108
10	42	37	1.22	10	083170110

8020

radance tipo leggero
zincate

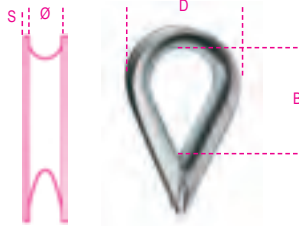

CERTIFICATI DISPONIBILI

• Specifica Prodotto

• Rapporto di Prova tipo 2.2 UNI EN10204

Ø mm	S mm	B mm	D mm	CHF	📄	🏭
2-3	0,8	20	20	0.21	350	080200003
4	1,0	22	21	0.21	300	080200004
5	1,0	23	24	0.23	300	080200005
6	1,0	27	29	0.25	200	080200006
8	1,2	33	33	0.41	180	080200008
10	1,5	40	39	0.62	100	080200010
12	1,8	44	46	0.73	160	080200012
14	2,0	49	50	0.87	100	080200014
16	2,0	57	59	1.19	150	080200016
18	2,5	68	69	1.79	100	080200018
20	3,0	78	77	2.69	70	080200020
22	3,0	88	84	2.82	60	080200022
24	3,5	92	91	3.85	40	080200025

Ø mm	S mm	CHF	📄	🏭
2-3	0,8	150	31.50	1 080200703
4	1,0	150	31.50	1 080200704
5	1,0	100	23.00	1 080200705
6	1,0	100	25.00	1 080200706
8	1,2	50	20.50	1 080200708
10	1,5	30	18.60	1 080200710

8021

radance tipo pesante
zincate

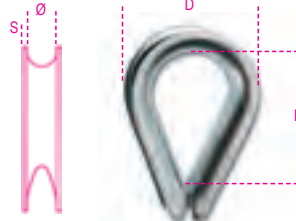

CERTIFICATI DISPONIBILI

• Specifica Prodotto

• Rapporto di Prova tipo 2.2 UNI EN10204

Ø mm	S mm	B mm	D mm	CHF	📄	🏭
5	1,7	29	28	0.51	120	080210005
6	1,8	33	30	0.56	100	080210006
8	2,5	36	37	0.70	100	080210008
10	2,5	42	43	0.96	80	080210010
12	2,5	48	50	1.15	100	080210012
14	2,7	58	57	1.60	70	080210014
16	3,0	61	62	1.92	50	080210016
18	3,5	71	71	2.50	70	080210018
20	4,0	79	79	3.65	60	080210020
22	4,0	87	84	4.10	50	080210022
24	4,0	93	92	5.10	40	080210024
26	4,0	103	103	6.50	35	080210026
28	5,0	107	116	14.10	1	080210028
30	5,0	118	121	15.60	1	080210030
32	5,5	138	135	17.90	1	080210032
35	6,0	140	147	27.00	1	080210035
40	6,0	173	170	35.00	1	080210040

8025

grilli per sollevamento diritti, tipo largo
acciaio al carbonio
zincati

CE

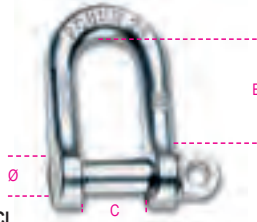

GRADO 4

DATI TECNICI

• coefficiente di sicurezza: 5
• trattamento termico: normalizzazione
• codice lotto di fabbricazione

ANALISI DI LABORATORIO

• analisi chimica • analisi metallografica • test di trazione

CERTIFICATI DISPONIBILI

• Specifica Prodotto • Rapporto di Prova tipo 2.2 UNI EN10204

• Certificato di Controllo tipo 3.1 UNI EN10204

• Dichiarazione di Conformità CE

Ø mm	"	B x C mm	WLL kg	CHF	📄	🏭
5	3/16	21x10	70	1.44	250	080250005
6	1/4	25x12	100	1.92	250	080250006
8	5/16	33x16	250	2.95	150	080250008
10	3/8	42x20	400	3.35	180	080250010
11	7/16	46x22	500	4.00	130	080250011
12	1/2	50x24	600	4.35	100	080250012
14	9/16	57x28	800	5.70	70	080250014
16	5/8	61x32	1000	7.50	15	080250016
18	11/16	65x36	1300	10.70	15	080250018
20	3/4	70x40	1600	12.50	10	080250020
22	7/8	74x44	2000	17.70	10	080250022
25	1"	80x48	2800	23.10	5	080250025

confezioni speciali

Ø mm	"	CHF	📄	🏭
5	3/16	25	36.00	1 080250705
6	1/4	25	48.00	1 080250706
8	5/16	25	73.50	1 080250708

Ø mm	"	CHF	📄	🏭
10	3/8	15	50.00	1 080250710
11	7/16	12	48.00	1 080250711
12	1/2	12	52.00	1 080250712
14	9/16	10	57.00	1 080250714

8026A

grilli per sollevamento diritti, tipo UNI
acciaio al carbonio
zincati

CE

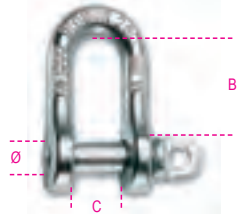

GRADO 4

DATI TECNICI

• coefficiente di sicurezza: 5
• trattamento termico: normalizzazione
• codice lotto di fabbricazione

ANALISI DI LABORATORIO

• analisi chimica

• analisi metallografica

• test di trazione

CERTIFICATI DISPONIBILI

• Specifica Prodotto

• Rapporto di Prova tipo 2.2 UNI EN10204

• Certificato di Controllo tipo 3.1 UNI EN10204

• Dichiarazione di Conformità CE

Ø mm	"	B x C mm	WLL kg	CHF	📄	🏭
12	1/2	42x20	630	4.35	35	080260012
14	9/16	46x22	800	5.50	30	080260014
16	5/8	50x24	1000	7.10	20	080260016
18	11/16	54x26	1300	10.00	15	080260018
20	3/4	58x28	1600	12.00	10	080260020
22	7/8	69x32	2000	17.10	10	080260022
25	1"	79x36	2500	23.00	5	080260025
28	1 1/8	90x40	3150	30.00	2	080260028
32	1 1/4	100x45	4000	42.00	2	080260032
36	1 3/8	110x50	5000	62.00	1	080260036
40	1 9/16	120x55	6300	86.00	1	080260040
42	1 5/8	131x60	8000	115.00	1	080260042
45	1 3/4	143x65	10000	155.00	1	080260045
50	2"	155x70	12500	196.00	1	080260050

 Robur

8026R

grilli per sollevamento diritti, perno a vite, acciaio legato ad alta resistenza staffa zincata a caldo

CE

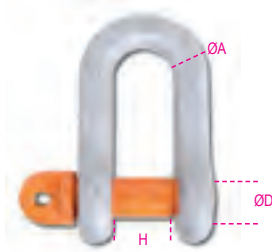

EN 13889
GRADE 6

DATI TECNICI

- coefficiente di sicurezza minimo: 6
- trattamento termico: bonifica
- codice lotto fabbricazione su perno e staffa

ANALISI DI LABORATORIO

- analisi chimica
- analisi metallografica
- test di trazione
- test di fatica (min. 20.000 cicli)
- test carico di collaudo (2 x wll)

CERTIFICATI DISPONIBILI

- Specifica Prodotto
- Rapporto di Prova tipo 2.2 UNI EN10204
- Certificato di Controllo tipo 3.1 UNI EN10204
- Dichiarazione di Conformità CE

ØA mm	ØD mm	H mm	WLL kg		
13	16	21	2000	5	080260212
16	19	27	3250	3	080260216
19	22	32	4750	2	080260219
22	25	37	6500	2	080260222

8531

grilli tipo pesca zincati a caldo

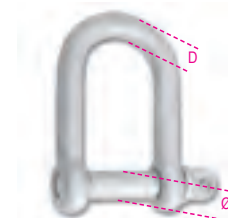

CERTIFICATI DISPONIBILI

- Rapporto di Prova tipo 2.2 UNI EN10204

Ø mm	D mm	WFL kg		
20	18	1600	1	085310018
22	20	2500	1	085310020

8532

grilli tipo pesca con perno quadro, verniciati neri



CERTIFICATI DISPONIBILI

- Rapporto di Prova tipo 2.2 UNI EN10204

Ø mm	D mm	WFL kg		
20	20	1600	1	085320020
22	22	2500	1	085320022

8028

grilli per sollevamento a lira acciaio al carbonio zincati

CE

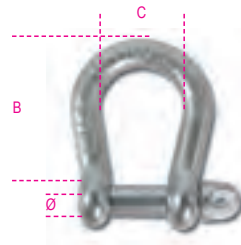

GRADO 4

DATI TECNICI

- coefficiente di sicurezza: 5
- trattamento termico: normalizzazione
- codice lotto di fabbricazione

ANALISI DI LABORATORIO

- analisi chimica
- analisi metallografica
- test di trazione

CERTIFICATI DISPONIBILI

- Specifica Prodotto
- Rapporto di Prova tipo 2.2 UNI EN10204
- Certificato di Controllo tipo 3.1 UNI EN10204
- Dichiarazione di Conformità CE

Ø mm	B x C mm	WLL kg		
5	3/16	20x16	80	100 080280105
6	1/4	24x20	100	70 080280106
8	5/16	32x24	200	35 080280108
10	3/8	40x33	300	25 080280110
11	7/16	44x36	400	15 080280111
12	1/2	48x39	500	15 080280112
14	9/16	56x46	600	7 080280114
16	5/8	64x46	800	10 080280116
18	11/16	71x59	950	5 080280118
20	3/4	80x65	1100	5 080280120
22	7/8	88x72	1500	5 080280122
25	1"	100x81	2000	2 080280125
28	1.1/8	112x91	2600	1 080280128
32	1.1/4	128x104	3200	1 080280132
38	1.1/2	152x124	4500	1 080280138

8029R - 8029

grilli a lira per sollevamento, perno a vite acciaio legato ad alta resistenza staffa zincata a caldo

CE

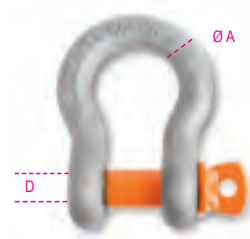

EN 13889
GRADO 6

DATI TECNICI

- coefficiente di sicurezza minimo: 6
- trattamento termico: bonifica
- codice lotto fabbricazione su perno e staffa

ANALISI DI LABORATORIO

- analisi chimica
- analisi metallografica
- test di trazione
- test di fatica (min. 20.000 cicli)
- test carico di collaudo (2 x wll)

CERTIFICATI DISPONIBILI

- Specifica Prodotto
- Rapporto di Prova tipo 2.2 UNI EN10204
- Certificato di Controllo tipo 3.1 UNI EN10204
- Dichiarazione di Conformità CE

	ØA mm	ØD mm	WLL kg		
8029R	6	8 (5/16)	500	20	080290106
8029R	8	10 (3/8)	750	15	080290108
8029R	10	11 (7/16)	1000	15	080290110
8029R	11	13 (1/2)	1500	10	080290111
8029R	13	16 (5/8)	2000	8	080290112
8029R	16	19 (3/4)	3250	5	080290116
8029R	19	22 (7/8)	4750	2	080290120
8029R	22	25 (1")	6500	2	080290122
8029R	26	28 (1.1/8)	8500	1	080290124
8029R	29	32 (1.1/4)	9500	1	080290128
8029R	32	35 (1.3/8)	12000	1	080290132
8029R	35	38 (1.1/2)	13500	1	080290135
8029R	38	42 (1.5/8)	17000	1	080290138
8029R	45	50 (2")	25000	1	080290145

	ØA mm	ØD mm	WLL kg		
* 8029	50	57 (2".1/4)	35000	1	080290057
* 8029	57	65 (2".9/16)	42500	1	080290065
* 8029	65	70 (2".3/4)	55000	1	080290070

*Misure non contemplate nella norma

Robur

Robur

8032

grilli a lira per sollevamento, perno a foro quadro
acciaio legato ad alta resistenza
staffa zincata a caldo

CE

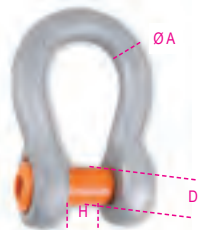

GRADE 6

DATI TECNICI

- coefficiente di sicurezza minimo: 6
- trattamento termico: bonifica
- codice lotto fabbricazione su perno e staffa

ANALISI DI LABORATORIO

- analisi chimica
- analisi metallografica
- test di trazione
- test di fatica (min.20.000 cicli)
- test carico di collaudo (2 x wll)

CERTIFICATI DISPONIBILI

- Specifica Prodotto
- Rapporto di Prova tipo 2.2 UNI EN10204
- Certificato di Controllo tipo 3.1 UNI EN10204
- Dichiarazione di Conformità CE

ØA mm	ØD mm (*)	H mm	WLL kg		
13	16 (5/8)	21	2000	5	080320012
16	19 (3/4)	27	3250	3	080320016
19	22 (7/8)	32	4750	2	080320020
22	25 (1)	37	6500	2	080320022

8031R

grilli per sollevamento a lira con dado e copiglia
acciaio legato ad alta resistenza
staffa zincata a caldo

CE

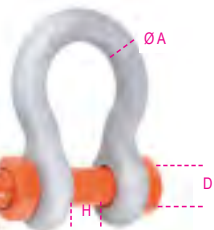

EN 13889
GRADO 6

DATI TECNICI

- coefficiente di sicurezza minimo: 6
- trattamento termico: bonifica
- codice lotto fabbricazione su perno e staffa

ANALISI DI LABORATORIO

- analisi chimica
- analisi metallografica
- test di trazione
- test di fatica (min.20.000 cicli)
- test carico di collaudo (2 x wll)

CERTIFICATI DISPONIBILI

- Specifica Prodotto
- Rapporto di Prova tipo 2.2 UNI EN10204
- Certificato di Controllo tipo 3.1 UNI EN10204
- Dichiarazione di Conformità CE

ØA mm	ØD mm (*)	H mm	WLL kg		
13	16 (5/8)	21	2000	5	080310112
16	19 (3/4)	27	3250	3	080310116
19	22 (7/8)	32	4750	2	080310120
22	25 (1)	37	6500	2	080310122
26	28 (1.1/8)	43	8500	1	080310124
29	32 (1.1/4)	48	9500	1	080310128
32	35 (1.3/8)	53	12000	1	080310132
35	38 (1.1/2)	59	13500	1	080310135
38	42 (1.5/8)	62	17000	1	080310138
45	50 (2)	75	25000	1	080310145

DIN 580 / 582 : 2010				
	WLL I kg	WLL II kg	WLL III kg	WLL IV kg
*M6	90	140	140	90
M8	140	140	140	90
M10	230	230	230	180
M12	340	340	340	240
*M14	480	480	480	330
M16	700	700	700	480
*M18	930	930	930	650
M20	1200	1200	1200	840
*M22	1450	1450	1450	1020
M24	1800	1800	1800	1270
*M27	2400	2400	2400	1690
M30	3200	3200	3200	2260
*M33	3900	3900	3900	2720
M36	4800	4800	4800	3220
M42	6300	6300	6300	4450
M48	8600	8600	8600	6080
M56	11200	11200	11200	8130
M64	14000	14000	14000	11130

8040EZ

golfari per sollevamento DIN 580
maschio, zincati

CE



DIN 580:2010-09

DATI TECNICI

- coefficiente di sicurezza: 6
- trattamento termico: normalizzazione
- codice lotto di fabbricazione

ANALISI DI LABORATORIO

- analisi chimica
- analisi metallografica
- test di trazione

CERTIFICATI DISPONIBILI

- Specifica Prodotto
- Rapporto di Prova tipo 2.2 UNI EN10204
- Certificato di Controllo tipo 3.1 UNI EN10204
- Dichiarazione di Conformità CE

Ø mm	WLL kg	E mm		
* M6	90	11	60	080400406
M8	140	13	60	080400408
M10	230	17	50	080400410
M12	340	20,5	25	080400412
* M14	480	27	25	080400414
M16	700	27	15	080400416
* M18	930	27	15	080400418
M20	1200	30	10	080400420
* M22	1450	30	10	080400422
M24	1800	36	5	080400424
* M27	2400	41	5	080400427
M30	3200	45	2	080400430
* M33	3900	54	2	080400433
* M33F	3900	54	2	080400434
M36	4800	54	2	080400436
* M36F	4800	54	2	080400437
M42	6300	63	1	080400442
* M42F	6300	63	1	080400443
M48	8600	68	1	080400448
* M48F	8600	68	1	080400449
M56	11500	78	1	080400456
* M56F	11500	78	1	080400457
M64	16000	90	1	080400464
* M64F	16000	90	1	080400465

*Misure non contemplate nella norma, dimensionate secondo Fascicolo Tecnico Robur

8040EN

golfari per sollevamento DIN 580
maschio, neri

CE



DIN 580:2010-09

DATI TECNICI

- coefficiente di sicurezza: 6
- trattamento termico: normalizzazione
- codice lotto di fabbricazione

ANALISI DI LABORATORIO

- analisi chimica
- analisi metallografica
- test di trazione

CERTIFICATI DISPONIBILI

- Specifica Prodotto
- Rapporto di Prova tipo 2.2 UNI EN10204
- Certificato di Controllo tipo 3.1 UNI EN10204
- Dichiarazione di Conformità CE

Ø mm	WLL kg	E mm		
* M6	90	11	60	080400306
M8	140	13	60	080400308
M10	230	17	50	080400310
M12	340	20,5	25	080400312
* M14	480	27	25	080400314
M16	700	27	15	080400316
* M18	930	27	15	080400318
M20	1200	30	10	080400320
* M22	1450	30	10	080400322
M24	1800	36	5	080400324
* M27	2400	41	5	080400327
M30	3200	45	2	080400330
* M33	3900	54	2	080400333
* M33F	3900	54	2	080400334
M36	4800	54	2	080400336
* M36F	4800	54	2	080400337
M42	6300	63	1	080400342
* M42F	6300	63	1	080400343
M48	8600	68	1	080400348
* M48F	8600	68	1	080400349
M56	11500	78	1	080400356
* M56F	11500	78	1	080400357
M64	16000	90	1	080400364
* M64F	16000	90	1	080400365

*Misure non contemplate nella norma, dimensionate secondo Fascicolo Tecnico Robur



DIN 580 / 582 : 2010				
	WLL I	WLL II	WLL III	WLL IV
	kg	kg	kg	kg
*M6	30	30	30	60
M8	140	140	140	56
M10	230	230	230	110
*M12	340	340	340	170
*M14	480	480	480	240
M16	630	630	630	315
*M18	930	930	930	465
M20	1200	1200	1200	600
*M22	1450	1450	1450	725
M24	1800	1800	1800	900
*M27	2400	2400	2400	1200
M30	3200	3200	3200	1600
*M33	3900	3900	3900	1950
M36	4800	4800	4800	2400
M42	6300	6300	6300	3150
M48	8600	8600	8600	4300
M54	11300	11300	11300	5650
M64	14900	14900	14900	7450

8042EZ

golfari per sollevamento DIN 582
femmina, zincati

CE

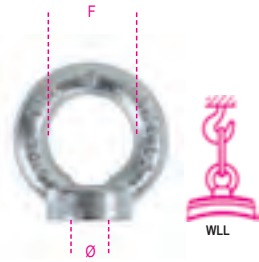

DIN 582:2010-09

DATI TECNICI

- coefficiente di sicurezza: 6
- trattamento termico: normalizzazione
- codice lotto di fabbricazione

ANALISI DI LABORATORIO

- analisi chimica
- analisi metallografica
- test di trazione

CERTIFICATI DISPONIBILI

- Specifica Prodotto
- Rapporto di Prova tipo 2.2 UNI EN10204
- Certificato di Controllo tipo 3.1 UNI EN10204
- Dichiarazione di Conformità CE

Ø	mm	F	mm	WLL	kg		
* M6	1	14	90	60	080420406		
M8	1,25	20	140	60	080420408		
M10	1,5	25	230	50	080420410		
M12	1,75	30	340	30	080420412		
* M14	2	30	480	30	080420414		
M16	2	35	700	20	080420416		
* M18	2,5	35	930	20	080420418		
M20	2,5	40	1200	15	080420420		
* M22	2,5	40	1450	15	080420422		
M24	3	50	1800	5	080420424		
* M27	3	55	2400	5	080420427		
M30	3,5	60	3200	3	080420430		
M36	4	70	4600	2	080420436		
* M36F	3	70	4600	2	080420437		
M42	4,5	80	6300	1	080420442		
* M42F	3	80	6300	1	080420443		
M48	5	90	8600	1	080420448		
* M48F	3	90	8600	1	080420449		

*Misure non contemplate nella norma,
dimensionate secondo Fascicolo Tecnico Robur

8042EN

golfari per sollevamento DIN 582
femmina, neri

CE



DIN 582:2010-09

DATI TECNICI

- coefficiente di sicurezza: 6
- trattamento termico: normalizzazione
- codice lotto di fabbricazione

ANALISI DI LABORATORIO

- analisi chimica
- analisi metallografica
- test di trazione

CERTIFICATI DISPONIBILI

- Specifica Prodotto
- Rapporto di Prova tipo 2.2 UNI EN10204
- Certificato di Controllo tipo 3.1 UNI EN10204
- Dichiarazione di Conformità CE

Ø	mm	F	mm	WLL	kg		
* M6	1	14	90	60	080420306		
M8	1,25	20	140	60	080420308		
M10	1,5	25	230	50	080420310		
M12	1,75	30	340	30	080420312		
* M14	2	30	480	30	080420314		
M16	2	35	700	20	080420316		
* M18	2,5	35	930	20	080420318		
M20	2,5	40	1200	15	080420320		
* M22	2,5	40	1450	15	080420322		
M24	3	50	1800	5	080420324		
* M27	3	55	2400	5	080420327		
M30	3,5	60	3200	3	080420330		
M36	4	70	4600	2	080420336		
* M36F	3	70	4600	2	080420337		
M42	4,5	80	6300	1	080420342		
* M42F	3	80	6300	1	080420343		
M48	5	90	8600	1	080420348		
* M48F	3	90	8600	1	080420349		

*Misure non contemplate nella norma,
dimensionate secondo Fascicolo Tecnico Robur



8044

golfari per sollevamento UNI 2948
femmina, neri

CE



UNI 2948

DATI TECNICI

- coefficiente di sicurezza: 4
- trattamento termico: normalizzazione
- codice lotto di fabbricazione

ANALISI DI LABORATORIO

- analisi chimica
- analisi metallografica
- test di trazione

CERTIFICATI DISPONIBILI

- Specifica Prodotto
- Rapporto di Prova tipo 2.2 UNI EN10204
- Certificato di Controllo tipo 3.1 UNI EN10204
- Dichiarazione di Conformità CE

Ø	mm	F	mm	WLL	kg		
M8	1,25	80	4	080440008			
M10	1,5	160	4	080440010			
M12	1,75	250	4	080440012			
M14	2	250	2	080440014			
M16	2	400	2	080440016			
M20	2,5	630	2	080440020			
M24	3	1000	2	080440024			

8041

golfari maschio per sollevamento,
acciaio legato ad alta resistenza

CE



DATI TECNICI

- coefficiente di sicurezza: 4
- trattamento termico: bonifica
- codice lotto fabbricazione

ANALISI DI LABORATORIO

- analisi chimica
- analisi metallografica
- test di trazione
- test di fatica (20.000 cicli)
- carico di collaudo (100% del lotto)

CERTIFICATI DISPONIBILI

- Specifica Prodotto
- Rapporto di Prova tipo 2.2 UNI EN10204
- Certificato di Controllo tipo 3.1 UNI EN10204
- Dichiarazione di Conformità CE

Ø	mm	F	mm	E	mm	WLL	kg		
* M8	1,25	13	600	10	080410208				
* M10	1,5	17	800	6	080410210				
* M12	1,75	20,5	1300	4	080410212				
* M16	2	27	3200	2	080410216				
* M20	2,5	30	4800	2	080410220				
* M24	3	36	6500	2	080410224				
* M30	3,5	45	9500	1	080410230				

(*) Caratteristiche dimensionali DIN 580:2010;
WLL incrementato in base a Fascicolo Tecnico Robur

8043

golfari femmina per sollevamento,
acciaio legato ad alta resistenza

CE



DATI TECNICI

- coefficiente di sicurezza: 4
- trattamento termico: bonifica
- codice lotto fabbricazione

ANALISI DI LABORATORIO

- analisi chimica
- analisi metallografica
- test di trazione
- test di fatica (20.000 cicli)
- carico di collaudo (100% del lotto)

CERTIFICATI DISPONIBILI

- Specifica Prodotto
- Rapporto di Prova tipo 2.2 UNI EN10204
- Certificato di Controllo tipo 3.1 UNI EN10204
- Dichiarazione di Conformità CE

Ø	F	WLL		
mm	mm	mm	kg	
* M8	1,25	20	600	10 080430208
* M10	1,50	25	800	6 080430210
* M12	1,75	30	1300	4 080430212
* M16	2	35	3200	2 080430216
* M20	2,5	40	4800	2 080430220
* M24	3	50	6500	2 080430224
* M30	3,5	60	9500	1 080430230

(* Caratteristiche dimensionali DIN 582:2010;
WLL incrementato in base a Fascicolo Tecnico Robur

8049

golfari maschio per sollevamento,
orientabili a doppia articolazione,
acciaio legato ad alta resistenza

CE

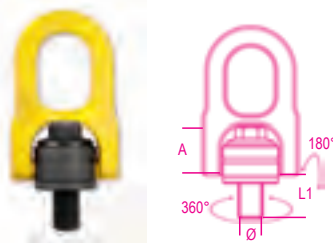

DATI TECNICI

- coefficiente di sicurezza: 5
- trattamento termico: bonifica
- codice lotto fabbricazione

ANALISI DI LABORATORIO

- analisi chimica
- analisi metallografica
- test di trazione
- test di fatica (20.000 cicli)

CERTIFICATI DISPONIBILI

- Specifica Prodotto
- Rapporto di Prova tipo 2.2 UNI EN10204
- Certificato di Controllo tipo 3.1 UNI EN10204
- Dichiarazione di Conformità CE

Ø	A	L1	WLL		
mm	mm	mm	kg		
M8	31,5	14	300	1	080490008
M10	31,5	17	600	1	080490010
M12	31,5	21	1000	1	080490012
M16	45	27	1600	1	080490016
M20	45	30	2500	1	080490020
M24	60,5	36	4000	1	080490024
M30	60,5	45	6300	1	080490030

8049 WLL (t)

	A°	M8	M10	M12	M16	M20	M24	M30
	0°	0,3	0,6	1	1,6	2,5	4	6,3
	90°	0,6	1,2	2	3,2	5	8	12,6
	90°	0,3	0,6	1	1,6	2,5	4	6,3
	45°	0,4	0,8	1,4	2,2	3,5	5,6	8,8
	60°	0,3	0,6	1	1,6	2,5	4	6,3
	60°	0,6	1,3	2,1	3,4	5,3	8,4	13,2
	60°	0,3	0,6	1	1,6	2,3	4	6,3

8048

tiranti ad occhio
destri
neri



UNI 6058

CERTIFICATI DISPONIBILI

- Specifica Prodotto
- Rapporto di Prova tipo 2.2 UNI EN10204

ØxL	F		
mm	mm		
M8x50	6	1	080480108
M8x65	6	1	080480109
M10x80	8	1	080480110
M10x100	8	1	080480210
M10x130	8	1	080480111
M12x70	10	1	080480212
M12x95	10	1	080480112
M12x125	10	1	080480113
M14x110	12	1	080480114
M16x100	14	1	080480115
M16x130	14	1	080480116
M18x150	16	1	080480118
M20x160	18	1	080480120
M22x180	18	1	080480122
M24x200	20	1	080480124
M27x220	22	1	080480127

8074

moschettoni DIN 5299
zincati

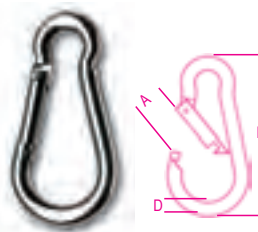

DIN 5299

DATI TECNICI

- coefficiente di sicurezza: 4
- Specifica Prodotto
- Rapporto di Prova tipo 2.2 UNI EN10204

DxL	A	WFL		
mm	mm	kg		
* 4x40	6	20	100	080740040
5x50	7	30	100	080740050
6x60	8	40	100	080740060
7x70	9	60	50	080740070
8x80	11	75	50	080740080
9x90	12	100	25	080740090
10x100	13	120	25	080740100

*Misure non contemplate nella norma

DxL	A	WFL		
mm	mm	kg		
11x120	16	140	20	080740101
12x140	22	140	15	080740102
13x160	24	200	10	080740103
* 14x180	32	250	5	080740104

*Misure non contemplate nella norma

8080

maglie rapide di giunzione
zincate



DATI TECNICI

- coefficiente di sicurezza: 4
- Specifica Prodotto
- Rapporto di Prova tipo 2.2 UNI EN10204

DxL	A	WFL		
mm	mm	kg		
3,5x36	5	20	100	080800003
4x40	6	30	100	080800004
5x49	6	50	100	080800005
6x57	8	60	100	080800006
7x66	8	100	50	080800007
8x74	11	140	50	080800008
9x80	11	160	25	080800009
10x89	11	220	25	080800010
12x105	15	300	20	080800012

8082

Anelli
acciaio zincato

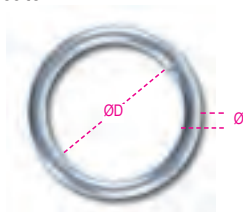

Ø	ØD		
mm	mm		
4	20	50	080820004
5	30	20	080820005
6	40	10	080820006
7	50	5	080820007
8	60	5	080820008

8083

ganci a "S"
acciaio zincato

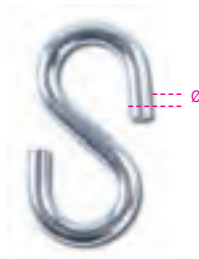

Ø	L mm		
mm	mm		
3	33	40	080830003
4	40	30	080830004
5	47	20	080830005
6	59	15	080830006
8	79	5	080830008

8114

tornichetti in acciaio
tipo Marche
zincati

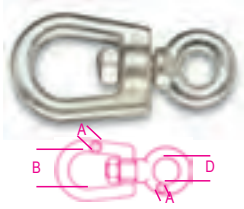

DATI TECNICI

• coefficiente di sicurezza: 4

• codice di identificazione

ANALISI DI LABORATORIO

• test di trazione

CERTIFICATI DISPONIBILI

• Specifica Prodotto

• Rapporto di Prova tipo 2.2 UNI EN10204

A mm	B mm	D mm	WFL kg		
8	30	16	250	1	081140008
10	38	18	300	1	081140010
12	42	20	650	1	081140012
14	48	22	820	1	081140014
16	57	24	1000	1	081140016
18	64	26	1600	1	081140018
20	72	30	2000	1	081140020
22	80	34	2500	1	081140022

8116

tornichetti in acciaio
tipo Sicilia
zincati

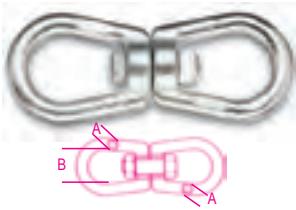

DATI TECNICI

• coefficiente di sicurezza: 4

• codice di identificazione

ANALISI DI LABORATORIO

• test di trazione

CERTIFICATI DISPONIBILI

• Specifica Prodotto

• Rapporto di Prova tipo 2.2 UNI EN10204

A mm	B mm	WFL kg		
6	23	140	1	081160006
8	30	250	1	081160008
10	38	300	1	081160010
12	42	650	1	081160012
14	48	820	1	081160014
16	57	1000	1	081160016
18	64	1600	1	081160018
20	72	2000	1	081160020
22	80	2500	1	081160022

8120

catene tipo Genovese
per collegamenti statici,
zincate



DATI TECNICI

• coefficiente di sicurezza: 4

CERTIFICATI DISPONIBILI

• Specifica Prodotto

• Rapporto di Prova tipo 2.2 UNI EN10204

Ø mm	nr	WFL kg	m		
1,6	12	15	150	1	081200016
2,2	14	25	75	1	081200022
2,7	16	37	75	1	081200027
3,4	18	75	60	1	081200034
3,8	19	100	50	1	081200038
4,4	20	125	40	1	081200044
4,8	21	165	30	1	081200048
5,5	22	185	25	1	081200055
5,8	23	225	25	1	081200058
6,5	24	265	25	1	081200065
7,5	26	350	20	1	081200075
* 8,0	27	400	25	1	081200080
* 10,0	30	625	20	1	081200100
* 12,0	32	900	15	1	081200120

Attenzione: prodotto NON destinato al sollevamento

(*) confezionati in MATASSE

8130

catene antifurto in acciaio legato
cementate e bonificate
zincate



Ø mm	L mm		
6	800	1	081300068
8	1000	1	081300081
8	1200	1	081300082
10	1500	1	081300105

8139Z

Lucchetti per catene antifurto,
corpo in lega di zinco

• fornito con nr.3 chiavi mappate

• adatto a catene 6, 8, 10mm



Ø mm	L mm	H mm		
10	55	98	1	081390009

8131Z

catene antifurto con lucchetto



Ø mm	L mm		
6	800	1	081310068
8	1000	1	081310081
8	1200	1	081310082
10	1500	1	081310105

8300

golfari per ponteggi
completi di barretta e tassello
zincati

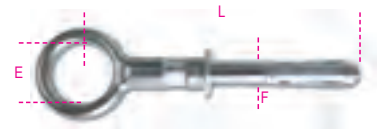

DATI TECNICI

• coefficiente di sicurezza: 3

• codice di identificazione

ANALISI DI LABORATORIO

• test di trazione

CERTIFICATI DISPONIBILI

• Dichiarazione di Conformità

A x of mm	E mm	L mm	WFL kg		
M12x18	50	220	850	20	083000012

8345

tasselli di ricambio per golfari da ponteggio



8345T12	20	083450025
8300 M12 ø18		

8302Z

viti ad occhio per tasselli
filettatura destra
zincate



DATI TECNICI

• coefficiente di sicurezza: 4

CERTIFICATI DISPONIBILI

• Specifica Prodotto

• Rapporto di Prova tipo 2.2 UNI EN10204

Ø mm	E mm	F mm	WFL kg		
M5	48	8	115	200	083020005
M6	55	10	160	150	083020006
M8	60	12	300	100	083020008
M10	73	14	470	100	083020010
M12	90	17	690	50	083020012

8303Z

ganci per tasselli filettatura destra zincati



DATI TECNICI

- coefficiente di sicurezza: 4
- CERTIFICATI DISPONIBILI
- Specifica Prodotto
- Rapporto di Prova tipo 2.2 UNI EN10204

Ø	C	E	WFL		
mm	mm	mm	kg		
M5	6,0	48	25	150	083030005
M6	8,0	55	45	120	083030006
M8	10,0	60	95	100	083030008
M10	12,5	73	140	70	083030010
M12	16,0	90	220	30	083030012

8381SL

collari per sostegno tubazioni serie leggera zincati

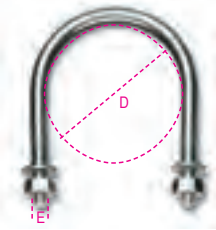

CERTIFICATI DISPONIBILI

- Specifica Prodotto
- Rapporto di Prova tipo 2.2 UNI EN10204

D	D	E		
mm	gas	mm		
11	1/8"	M6	100	083810201
14	1/4"	M6	100	083810202
18	3/8"	M6	100	083810203
22	1/2"	M6	100	083810204
27	3/4"	M6	100	083810205
34	1"	M6	100	083810206
43	1 1/4"	M6	100	083810207
49	1 1/2"	M8	50	083810208
61	2"	M8	50	083810209
77	2 1/2"	M8	25	083810210
89	3"	M8	25	083810211
102	3 1/2"	M8	25	083810212
115	4"	M8	25	083810213
168	6"	M10	25	083810218
220	8"	M10	10	083810220

8381SP

collari per sostegno tubazioni serie pesante zincati

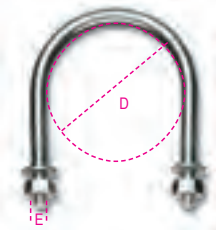

CERTIFICATI DISPONIBILI

- Specifica Prodotto
- Rapporto di Prova tipo 2.2 UNI EN10204

D	D	E		
mm	gas	mm		
22	1/2"	M8	100	083810301
27	3/4"	M8	100	083810302
34	1"	M8	100	083810303
43	1 1/4"	M8	100	083810304
49	1 1/2"	M10	50	083810305

D	D	E		
mm	gas	mm		
61	2"	M10	50	083810306
77	2 1/2"	M10	50	083810307
89	3"	M10	25	083810308
102	3 1/2"	M12	25	083810309
115	4"	M12	25	083810310
168	6"	M16	25	083810315
220	8"	M16	10	083810320
274	10"	M16	1	083810374

8383C

collari quadri zincati a caldo
Dadi flangiati

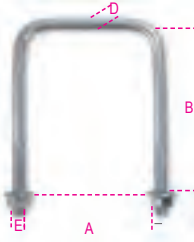

CERTIFICATI DISPONIBILI

- Specifica Prodotto
- Rapporto di Prova tipo 2.2 UNI EN10204

A	E	B	D		
mm	mm	mm	mm		
70	M10	110	8,55	130	083830070
80	M10	120	8,55	110	083830080
90	M10	130	8,55	100	083830090
100	M10	155	8,55	90	083830100
120	M10	175	8,55	70	083830120

8383P

piastre per collari quadri zincate a caldo

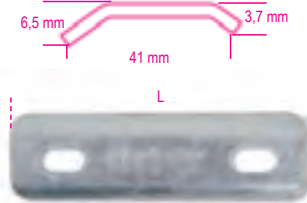

CERTIFICATI DISPONIBILI

- Specifica Prodotto
- Rapporto di Prova tipo 2.2 UNI EN10204

	L		
	mm		
8383P/150	150	150	083830214
8383C/70-80			
/90-100			
8383P/170	170	120	083830217
8383C/100-120			

8515Z

tirafili per agricoltura zincati

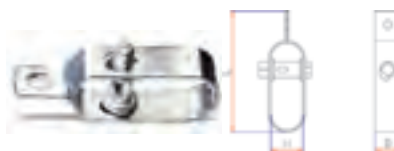

D	H	L		
mm	mm	mm		
20	25	93	100	085150002
24,5	30	100	100	085150003

8515V

tirafili per agricoltura zincati e verniciati

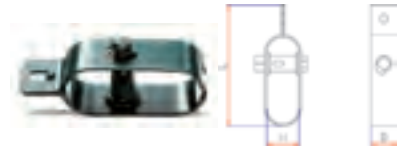

D	H	L		
mm	mm	mm		
20	25	93	100	085150102
24,5	30	100	100	085150103

8535

uncini tipo pesca zincati

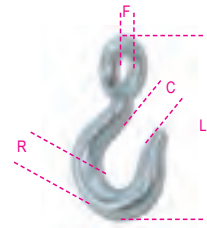

CERTIFICATI DISPONIBILI

- Rapporto di Prova tipo 2.2 UNI EN10204

R	C	F	L		
mm	mm	mm	mm		
26	27,5	34	156	1	085350006
30	36,5	40	185	1	085350007

8051S

ganci per sollevamento con sicura acciaio al carbonio zincati

CE



GRADO 4

DATI TECNICI

- coefficiente di sicurezza: 4
- trattamento termico: normalizzazione
- codice lotto di fabbricazione

ANALISI DI LABORATORIO

- analisi chimica
- analisi metallografica
- test di trazione

CERTIFICATI DISPONIBILI

- Specifica Prodotto
- Rapporto di Prova tipo 2.2 UNI EN10204
- Certificato di Controllo tipo 3.1 UNI EN10204
- Dichiarazione di Conformità CE

WLL	C	F		
kg	mm	mm		
250	14	12	20	080510202
500	18	16,5	10	080510205

8052 - 8055S

ganci per sollevamento ad occhio,
acciaio legato ad alta resistenza

CE



EN 1677-2
GRADE 8

DATI TECNICI

- coefficiente di sicurezza: 4
- trattamento termico: bonifica
- codice lotto fabbricazione
- ANALISI DI LABORATORIO**
- analisi chimica, analisi metallografica
- test carico di prova (2,5 x wll)
- test di trazione
- test di fatica (min. 20.000 cicli)
- CERTIFICATI DISPONIBILI**
- Specifica Prodotto
- Rapporto di Prova tipo 2.2 UNI EN10204
- Certificato di Controllo tipo 3.1 UNI EN10204
- Dichiarazione di Conformità CE

	WLL	C		
	kg	mm		
8052	800	18	1	080520008
8052	1120	22,5	1	080520011
8052	2000	30	1	080520020
8052	3150	36	1	080520031
8052	4000	39,5	1	080520040

	WLL	C		
	kg	mm		
8055S	5400	32	1	080550145
8055S	8000	41	1	080550170
8055S	11500	53	1	080550215
8055S	16000	58	1	080550260
8055S	22000	78	1	080550320

8057R - 8057

ganci per sollevamento
tipo self-locking ad occhio,
acciaio legato ad alta resistenza

CE



EN 1677-3
GRADE 8

DATI TECNICI

- coefficiente di sicurezza: 4
- trattamento termico: bonifica
- codice lotto fabbricazione
- ANALISI DI LABORATORIO**
- analisi chimica, analisi metallografica
- test di trazione
- test di fatica (min. 20.000 cicli)
- carico di collaudo (100% del lotto)
- CERTIFICATI DISPONIBILI**
- Specifica Prodotto
- Rapporto di Prova tipo 2.2 UNI EN10204
- Certificato di Controllo tipo 3.1 UNI EN10204
- Dichiarazione di Conformità CE

	WLL	J		
	kg	Ø mm	mm	
8057R	2000	7-8	34	1 080570120
8057R	3150	10	44	1 080570132

	WLL	J		
	kg	Ø mm	mm	
8057	5300	13	54	1 080570053

8058R - 8058

ganci per sollevamento
tipo self-locking a forcella
acciaio legato ad alta resistenza

CE



EN 1677-3
GRADE 8

DATI TECNICI

- coefficiente di sicurezza: 4
- trattamento termico: bonifica
- codice lotto fabbricazione
- ANALISI DI LABORATORIO**
- analisi chimica, analisi metallografica
- test di trazione
- test di fatica (min. 20.000 cicli)
- carico di collaudo (100% del lotto)
- CERTIFICATI DISPONIBILI**
- Specifica Prodotto
- Rapporto di Prova tipo 2.2 UNI EN10204
- Certificato di Controllo tipo 3.1 UNI EN10204
- Dichiarazione di Conformità CE

	WLL	J		
	kg	Ø mm	mm	
8058R	2000	7-8	34	1 080580120
8058R	3150	10	44	1 080580132

	WLL	J		
	kg	Ø mm	mm	
8058	5300	13	54	1 080580053
8058	8000	16	67	1 080580080

8060R - 8060

ganci per sollevamento
tipo Clevis a forcella,
acciaio legato ad alta resistenza

CE



EN 1677-2
GRADE 8

DATI TECNICI

- coefficiente di sicurezza: 4
- trattamento termico: bonifica
- codice lotto fabbricazione
- ANALISI DI LABORATORIO**
- analisi chimica, analisi metallografica
- test di trazione
- test di fatica (min. 20.000 cicli)
- carico di collaudo (100% del lotto)
- CERTIFICATI DISPONIBILI**
- Specifica Prodotto
- Rapporto di Prova tipo 2.2 UNI EN10204
- Certificato di Controllo tipo 3.1 UNI EN10204
- Dichiarazione di Conformità CE

	WLL	C		
	kg	Ø mm	mm	
8060R	1120	6		1 080600111
8060R	2000	7-8		1 080600120
8060R	3150	10		1 080600132
8060R	5300	13		1 080600153

	WLL	C		
	kg	Ø mm	mm	
8060	8000	16	48	1 080600080

8061R - 8061F

ganci accorciatori a forcella
con sicura di bloccaggio,
acciaio legato ad alta resistenza

CE



EN 1677-1
GRADO 8

DATI TECNICI

- coefficiente di sicurezza: 4
- trattamento termico: bonifica
- codice lotto fabbricazione
- ANALISI DI LABORATORIO**
- analisi chimica, analisi metallografica
- test di trazione
- test di fatica (min. 20.000 cicli)
- carico di collaudo (100% del lotto)
- CERTIFICATI DISPONIBILI**
- Specifica Prodotto
- Rapporto di Prova tipo 2.2 UNI EN10204
- Certificato di Controllo tipo 3.1 UNI EN10204
- Dichiarazione di Conformità CE

	WLL	E		
	kg	Ø mm	mm	
8061R	1120	6	8	1 080610211
8061R	2000	7-8	11	1 080610220
8061R	3150	10	13	1 080610231

	WLL	E		
	kg	Ø mm	mm	
8061F	5300	13	16,5	1 080610153
8061F	8000	16	20,5	1 080610180

8062

ganci scorsoi,
acciaio legato ad alta resistenza

CE

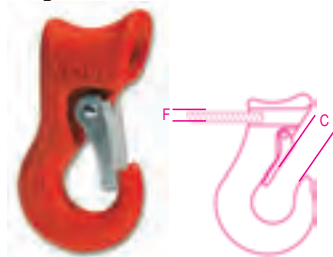

DATI TECNICI

- coefficiente di sicurezza: 5
- trattamento termico: bonifica
- codice lotto fabbricazione
- ANALISI DI LABORATORIO**
- analisi chimica, analisi metallografica
- test carico di prova (WLL x 2,5)
- test di trazione
- CERTIFICATI DISPONIBILI**
- Specifica Prodotto
- Rapporto di Prova tipo 2.2 UNI EN10204
- Certificato di Controllo tipo 3.1 UNI EN10204
- Dichiarazione di Conformità CE

	WLL	C	F		
	kg	mm	mm		
1500	19	10-13		1	080620013
2000	21	16		1	080620016
3000	26	18		1	080620018
5000	34	22-25		1	080620025

Robur

8063

ganci per sollevamento orientabili (non sotto carico) acciaio legato alta resistenza

CE

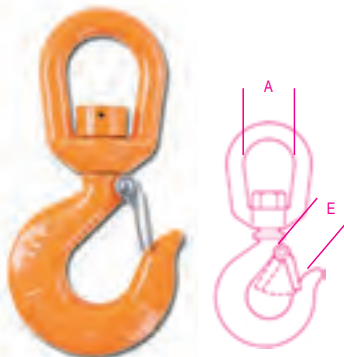

EN 1677-1
GRADE 8

DATI TECNICI

- coefficiente di sicurezza: 4
- trattamento termico: bonifica
- codice lotto fabbricazione
- ANALISI DI LABORATORIO
- analisi chimica, analisi metallografica
- test di trazione
- test di fatica (min. 20.000 cicli)
- carico di collaudo (100% del lotto)

CERTIFICATI DISPONIBILI

- Specifica Prodotto
- Rapporto di Prova tipo 2.2 UNI EN10204
- Certificato di Controllo tipo 3.1 UNI EN10204
- Dichiarazione di Conformità CE

WLL kg	A mm	E mm	
800	32	20,5	1 080630008
1120	38	20,5	1 080630011
2000	44,5	22	1 080630020
3150	44,5	27	1 080630031

8064S

ganci per sollevamento orientabili (non sotto carico) acciaio al carbonio

CE

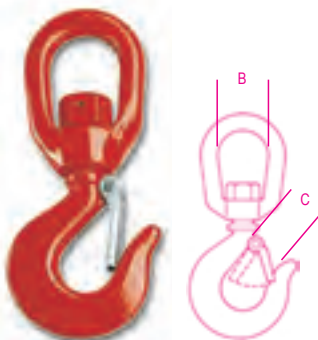

EN 1677-5
GRADE 4

DATI TECNICI

- coefficiente di sicurezza: 5
- trattamento termico: bonifica
- codice lotto fabbricazione
- ANALISI DI LABORATORIO
- analisi chimica, analisi metallografica
- test carico di prova (WLL x 2,5)
- test di trazione
- test di fatica (min. 20.000 cicli)

CERTIFICATI DISPONIBILI

- Specifica Prodotto
- Rapporto di Prova tipo 2.2 UNI EN10204
- Certificato di Controllo tipo 3.1 UNI EN10204
- Dichiarazione di Conformità CE

WLL kg	B mm	C mm	
800	31	20	1 080640107
1000	40	22	1 080640110
1600	47	23	1 080640115
2000	47	27	1 080640120
3200	64	35	1 080640130
5000	77	43	1 080640150
7500	90	53	1 080640175
10000	96	58	1 080640199

8065SC

ganci per sollevamento girevoli sotto carico, con cuscinetto acciaio al carbonio

CE

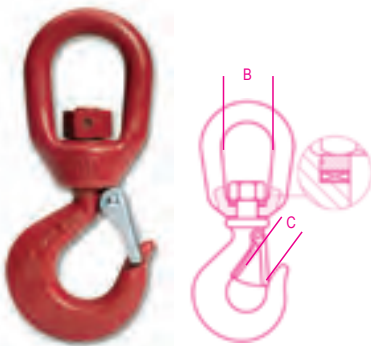

EN 1677-5
GRADE 4

DATI TECNICI

- coefficiente di sicurezza: 5
- trattamento termico: bonifica
- codice lotto fabbricazione
- ANALISI DI LABORATORIO
- analisi chimica, analisi metallografica
- test carico di prova (WLL x 2,5)
- test di trazione
- test di fatica (min. 20.000 cicli)

CERTIFICATI DISPONIBILI

- Specifica Prodotto
- Rapporto di Prova tipo 2.2 UNI EN10204
- Certificato di Controllo tipo 3.1 UNI EN10204
- Dichiarazione di Conformità CE

WLL kg	B mm	C mm	
800	31	20	1 080650107
1000	40	22	1 080650110
1600	47	23	1 080650115
2000	47	27	1 080650120
3200	64	35	1 080650130
5000	77	43	1 080650150

8050D

kit sicure e ricambi per ganci di sollevamento



8050D1 8055/1250 8064S-8065SC/800	1 080500945
8050D2 8055S/1600 8064S-8065SC/1000	1 080500946
8050D3 8055/2500-3200 8064S-8065SC/1600-2000	1 080500947
8050D4 8055S/5400 8064S-8065SC/3200	1 080500948
8050D5 8055S/8000 8064S-8065SC/5000	1 080500949
8050D6 8055S/11500 8064S/7500	1 080500950
8050D7 8060/3150	1 080500951
8050D8 8060/5300	1 080500952
8050D7A 8060/2000	1 080500968
8050D10 8062/1500	1 080500954
8050D11 8062/2000	1 080500955
8050D12 8062/3000	1 080500956
8050D13 8062/5000	1 080500957
8050D22 8055S/16000 8064S/10000	1 080500966
8050D23 8055S/22000	1 080500967
8050D24 8051S/250	1 080500969

8050D25 8051S/500	1 080500970
8050D26 8061F/1120	1 080500971
8050D27 8061F/2000	1 080500972
8050D28 8061F/3150	1 080500973
8050D29 8061F/5300	1 080500974
8050D30 8061F/8000	1 080500975
8050D31 8060/1120	1 080500976
8050D32 8060/8000	1 080500977
8050D33 8052/800	1 080500978
8050D34 8052/1120	1 080500979
8050D35 8052/2000	1 080500980
8050D36 8052/3150	1 080500981
8050D37 8052/4000	1 080500982
8050D38 8060R/1120	1 080500983
8050D39 8060R/2000	1 080500984
8050D40 8060R/3150	1 080500985
8050D41 8060R/5300	1 080500986
8050D42 8063R/800	1 080500987
8050D43 8063R/1120	1 080500988
8050D44 8063R/2000	1 080500989
8050D45 8063R/3150	1 080500990

8085

campanelle per sollevamento, acciaio legato ad alta resistenza

Il carico di lavoro WLL è relativo all'utilizzo con imbragature ad 1 braccio.

CE



EN 1677-4
GRADO 8

DATI TECNICI

- coefficiente di sicurezza: 4
 - trattamento termico: bonifica
 - codice lotto fabbricazione
 - ANALISI DI LABORATORIO
 - analisi chimica, analisi metallografica
 - test carico di prova (WLL x 2,5)
 - test di trazione
 - test di fatica (min. 20.000 cicli)
- CERTIFICATI DISPONIBILI
- Specifica Prodotto
 - Rapporto di Prova tipo 2.2 UNI EN10204
 - Certificato di Controllo tipo 3.1 UNI EN10204
 - Dichiarazione di Conformità CE

WLL kg	B mm	C mm	
*1500	7	110	1 080850016
2000	8	110	1 080850020
3150	10	135	1 080850032
5300	13	160	1 080850054
8000	16	180	1 080850080
11200	19	200	1 080850190

* Abbinata a catena ø 6, WLL= 1120 kg

8086

campanelle per sollevamento triple,
acciaio legato ad alta resistenza

Il carico di lavoro WLL è relativo all'utilizzo con imbragature a 3 o 4 bracci e angolo β inferiore a 45°

CE

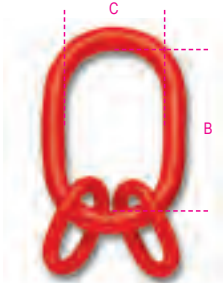

EN 1677-4
GRADO 8

DATI TECNICI

- coefficiente di sicurezza: 4
 - trattamento termico: bonifica
 - codice lotto fabbricazione
- ANALISI DI LABORATORIO
- analisi chimica, analisi metallografica
 - test carico di prova (WLL x 2,5)
 - test di trazione
 - test di fatica (min. 20.000 cicli)

CERTIFICATI DISPONIBILI

- Specifica Prodotto
- Rapporto di Prova tipo 2.2 UNI EN10204
- Certificato di Controllo tipo 3.1 UNI EN10204
- Dichiarazione di Conformità CE

WLL kg	Ø mm	B mm	C mm		
* 3150	7	135	75	1	080860021
4250	8	160	90	1	080860042
6700	10	180	100	1	080860067
11200	13	200	110	1	080860100
17000	16	260	140	1	080860117

* Abbinata a catena Ø 6mm, WLL= 2360 kg

8090

maglie di giunzione per sollevamento,
acciaio legato ad alta resistenza

CE

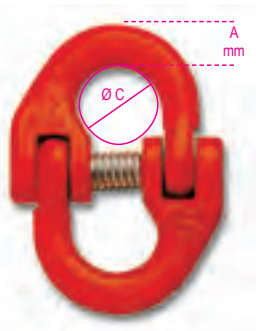

EN 1677-1
GRADO 8

DATI TECNICI

- coefficiente di sicurezza: 4
 - trattamento termico: bonifica
 - codice lotto fabbricazione
- ANALISI DI LABORATORIO
- analisi chimica, analisi metallografica
 - test carico di prova (WLL x 2,5)
 - test di trazione
 - test di fatica (min. 20.000 cicli)

CERTIFICATI DISPONIBILI

- Specifica Prodotto
- Rapporto di Prova tipo 2.2 UNI EN10204
- Certificato di Controllo tipo 3.1 UNI EN10204
- Dichiarazione di Conformità CE

WLL kg	Ø mm	ØC max	A mm		
1120	6	13	7	1	080900011
2000	7-8	18	9,5	1	080900020
3150	10	22	12	1	080900032
5300	13	26	17	1	080900053
8000	16	32	22	1	080900080

8090F

maglie di giunzione da sollevamento,
per brache in poliestere,
acciaio legato ad alta resistenza

CE

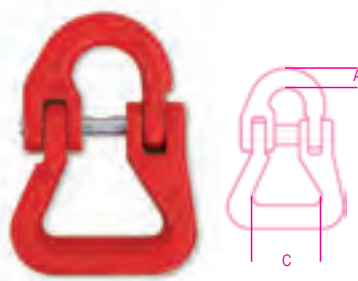

EN 1677-1
GRADO 8

DATI TECNICI

- coefficiente di sicurezza: 4
 - trattamento termico: bonifica
 - codice lotto fabbricazione
- ANALISI DI LABORATORIO
- analisi chimica, analisi metallografica
 - test carico di prova (WLL x 2,5)
 - test di trazione
 - test di fatica (min. 20.000 cicli)

CERTIFICATI DISPONIBILI

- Specifica Prodotto
- Rapporto di Prova tipo 2.2 UNI EN10204
- Certificato di Controllo tipo 3.1 UNI EN10204
- Dichiarazione di Conformità CE

WLL kg	Ø mm	A mm	C mm		
2000	7-8	10,5	40	1	080900220
3150	10	12	50	1	080900232
5300	13	17	60	1	080900253
8000	16	21	75	1	080900280

8100

catene per sollevamento,
acciaio legato ad alta resistenza

CE

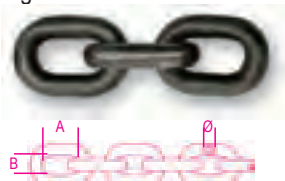

EN 818-2
GRADE 8

DATI TECNICI

- coefficiente di sicurezza: 4
 - trattamento termico: bonifica
 - codice lotto di fabbricazione
- ANALISI DI LABORATORIO
- analisi chimica
 - analisi metallografica
 - test di trazione
- CERTIFICATI DISPONIBILI
- Specifica Prodotto
 - Rapporto di Prova tipo 2.2 UNI EN10204
 - Certificato del Fabbriante EN818-2
 - Dichiarazione di Conformità CE

WLL kg	Ø mm	A mm	B mm		
1120	6	18	7,8	1	081000011
1500	7	21	9,1	1	081000016
2000	8	24	10,4	1	081000020
3150	10	30	13	1	081000032
5300	13	39	16,9	1	081000053
8000	16	48	20,8	1	081000080

* ATTENZIONE: il prodotto viene consegnato in un unico spezzone di catena, salvo diversa indicazione in fase d'ordine!

 **Robur**

PENDENTI DI CATENA
Grado 8

WLL Ton				UNI EN 818	
Ø D mm	WLL 1	WLL 2		Ø° < β ≤ 45°	45° < β ≤ 60°
		WLL 2	WLL 2		
6	1,12	1,6	1,12		
7	1,5	2,12	1,5		
8	2	2,8	2		
10	3,15	4,25	3,15		
13	5,3	7,5	5,3		
16	8	11,2	8		

Ø D mm	WLL 3	WLL 3		Ø° < β ≤ 45°	45° < β ≤ 60°
		WLL 3	WLL 3		
6	2,36	1,7	1,7		
7	3,15	2,34	2,34		
8	4,25	3	3		
10	6,7	4,75	4,75		
13	11,2	8	8		
16	17	11,2	11,2		

8091

pendenti per sollevamento
catena ad 1 braccio
in valigetta

CE

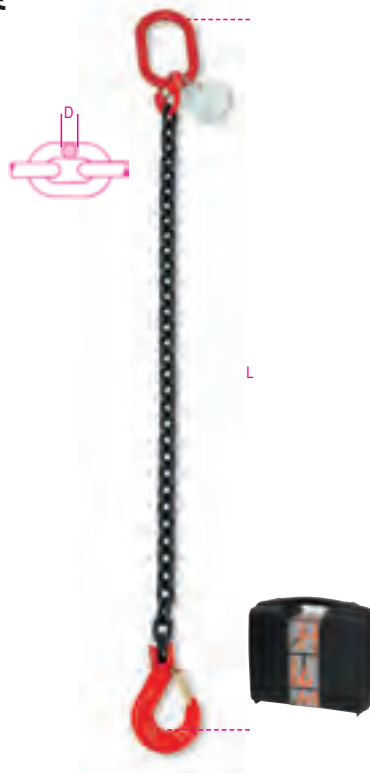

UNI EN 818-4

DATI TECNICI

- coefficiente di sicurezza: 4
 - piastrina di identificazione seriale
- CERTIFICATI ALLEGATI
- Certificato del Fabbricante UNI EN818-4
 - Dichiarazione di Conformità CE
- CERTIFICATI DISPONIBILI
- Specifica Prodotto

Ø D mm	L m	WLL ton	1	2
6	1	1,12	1	080910001
6	2	1,12	1	080910002
6	3	1,12	1	080910003
6	4	1,12	1	080910004
7	1	1,5	1	080910021
7	2	1,5	1	080910022
7	3	1,5	1	080910023
7	4	1,5	1	080910024
8	1	2	1	080910041
8	2	2	1	080910042
8	3	2	1	080910043
8	4	2	1	080910044
10	1	3,15	1	080910051
10	2	3,15	1	080910052
10	3	3,15	1	080910053
10	4	3,15	1	080910054
13	1	5,3	1	080910131
13	2	5,3	1	080910132
13	3	5,3	1	080910133
13	4	5,3	1	080910134
16	1	8	1	080910161
16	2	8	1	080910162
16	3	8	1	080910163
16*	4	8	1	080910164

* Imballo adeguato al peso

Robur

8092

pendenti per sollevamento
catena a 2 bracci
in valigetta

CE



UNI EN 818-4

DATI TECNICI

- coefficiente di sicurezza: 4
 - piastrina di identificazione seriale
- CERTIFICATI ALLEGATI
- Certificato del Fabbricante UNI EN818-4
 - Dichiarazione di Conformità CE
- CERTIFICATI DISPONIBILI
- Specifica Prodotto

Ø D mm	L m	WLL ton	1	2
6	1	1,6	1	080920001
6	2	1,6	1	080920002
6	3	1,6	1	080920003
6	4	1,6	1	080920004
7	1	2,12	1	080920021
7	2	2,12	1	080920022
7	3	2,12	1	080920023
7	4	2,12	1	080920024
8	1	2,8	1	080920041
8	2	2,8	1	080920042
8	3	2,8	1	080920043
8	4	2,8	1	080920044
10	1	4,25	1	080920051
10	2	4,25	1	080920052
10	3	4,25	1	080920053
10	4	4,25	1	080920054
13	1	7,5	1	080920131
13	2	7,5	1	080920132
13*	3	7,5	1	080920133
13*	4	7,5	1	080920134
16	1	11,2	1	080920161
16*	2	11,2	1	080920162
16*	3	11,2	1	080920163
16*	4	11,2	1	080920164

* Imballo adeguato al peso

Robur

8094

pendenti per sollevamento
catena a 4 bracci
in valigetta

CE



UNI EN 818-4

DATI TECNICI

- coefficiente di sicurezza: 4
- piastrina di identificazione seriale
CERTIFICATI ALLEGATI
- Certificato del Fabbricante UNI EN818-4
- Dichiarazione di Conformità CE
CERTIFICATI DISPONIBILI
- Specifica Prodotto

D mm	L m	WLL ton		
6	1	2,36	1	080940001
6	2	2,36	1	080940002
6	3	2,36	1	080940003
6	4	2,36	1	080940004
7	1	3,15	1	080940021
7	2	3,15	1	080940022
7	3	3,15	1	080940023
7	4	3,15	1	080940024
8	1	4,25	1	080940041
8	2	4,25	1	080940042
8	3	4,25	1	080940043
8	4	4,25	1	080940044
10	1	6,7	1	080940051
10	2	6,7	1	080940052
10	3	6,7	1	080940053
10	4	6,7	1	080940054
13*	1	11,2	1	080940131
13*	2	11,2	1	080940132
13*	3	11,2	1	080940133
13*	4	11,2	1	080940134
16*	1	17	1	080940161
16*	2	17	1	080940162
16*	3	17	1	080940163
16*	4	17	1	080940164

* Imballo adeguato al peso

8096

pendenti per sollevamento
con ganci accorciatori
catena ad 1 braccio, in valigetta

CE



UNI EN 818-4

DATI TECNICI

- coefficiente di sicurezza: 4
- piastrina di identificazione seriale
CERTIFICATI ALLEGATI
- Certificato del Fabbricante UNI EN818-4
- Dichiarazione di Conformità CE
CERTIFICATI DISPONIBILI
- Specifica Prodotto

D mm	L m	WLL ton		
6	1	1,12	1	080960001
6	2	1,12	1	080960002
6	3	1,12	1	080960003
6	4	1,12	1	080960004
7	1	1,5	1	080960021
7	2	1,5	1	080960022
7	3	1,5	1	080960023
7	4	1,5	1	080960024
8	1	2	1	080960041
8	2	2	1	080960042
8	3	2	1	080960043
8	4	2	1	080960044
10	1	3,15	1	080960051
10	2	3,15	1	080960052
10	3	3,15	1	080960053
10	4	3,15	1	080960054
13	1	5,3	1	080960131
13	2	5,3	1	080960132
13	3	5,3	1	080960133
13	4	5,3	1	080960134
16	1	8	1	080960161
16	2	8	1	080960162
16	3	8	1	080960163
16*	4	8	1	080960164

* Imballo adeguato al peso

8097

pendenti per sollevamento
con ganci accorciatori
catena a 2 bracci, in valigetta

CE



UNI EN 818-4

DATI TECNICI

- coefficiente di sicurezza: 4
- piastrina di identificazione seriale
CERTIFICATI ALLEGATI
- Certificato del Fabbricante UNI EN818-4
- Dichiarazione di Conformità CE
CERTIFICATI DISPONIBILI
- Specifica Prodotto

D mm	L m	WLL ton		
6	1	1,6	1	080970001
6	2	1,6	1	080970002
6	3	1,6	1	080970003
6	4	1,6	1	080970004
7	1	2,12	1	080970021
7	2	2,12	1	080970022
7	3	2,12	1	080970023
7	4	2,12	1	080970024
8	1	2,8	1	080970041
8	2	2,8	1	080970042
8	3	2,8	1	080970043
8	4	2,8	1	080970044
10	1	4,25	1	080970051
10	2	4,25	1	080970052
10	3	4,25	1	080970053
10	4	4,25	1	080970054
13	1	7,5	1	080970131
13	2	7,5	1	080970132
13*	3	7,5	1	080970133
13*	4	7,5	1	080970134
16	1	11,2	1	080970161
16*	2	11,2	1	080970162
16*	3	11,2	1	080970163
16*	4	11,2	1	080970164

* Imballo adeguato al peso

8098

pendenti per sollevamento
con ganci accorciatori
catena a 4 bracci, in valigetta

CE



UNI EN 818-4

DATI TECNICI

- coefficiente di sicurezza: 4
- piastrina di identificazione seriale

CERTIFICATI ALLEGATI

- Certificato del Fabbricante UNI EN818-4
- Dichiarazione di Conformità CE

CERTIFICATI DISPONIBILI

- Specifica Prodotto

D mm	L m	WLL ton	U	U
6	1	2,36	1	080980001
6	2	2,36	1	080980002
6	3	2,36	1	080980003
6	4	2,36	1	080980004
7	1	3,15	1	080980021
7	2	3,15	1	080980022
7	3	3,15	1	080980023
7	4	3,15	1	080980024
8	1	4,25	1	080980041
8	2	4,25	1	080980042
8	3	4,25	1	080980043
8	4	4,25	1	080980044
10	1	6,7	1	080980051
10	2	6,7	1	080980052
10	3	6,7	1	080980053
10	4	6,7	1	080980054
13*	1	11,2	1	080980131
13*	2	11,2	1	080980132
13*	3	11,2	1	080980133
13*	4	11,2	1	080980134
16*	1	17	1	080980161
16*	2	17	1	080980162
16*	3	17	1	080980163
16*	4	17	1	080980164

* Imballo adeguato al peso

BRACHE DI NASTRO IN POLIESTERE UNI EN1492-1 e UNI EN1492-2

DATI TECNICI

- coefficiente di sicurezza: 7
- codice lotto di fabbricazione

ANALISI DI LABORATORIO

- test di trazione

CERTIFICATI DISPONIBILI

- Specifica Prodotto

- Rapporto di Prova tipo 2.2 UNI EN10204

- Certificato del Fabbricante UNI EN1492

- Dichiarazione di Conformità CE

	UNI EN 1492-1		$\beta = 0^\circ - 45^\circ$		$\beta = 45^\circ - 60^\circ$
	L m	H mm	L m	H mm	L m
30	11	0,81	21	1,41	11
60	21	1,61	41	2,81	21
90	31	2,41	61	4,21	31
120	41	3,21	81	5,61	41
150	51	4,01	101	7,01	51
180	61	4,81	121	8,41	61
240	81	6,41	161	11,21	81
300	101	8,01	201	14,01	101

8150

brache per sollevamento 1t viola
nastro piatto a due strati, asole rinforzate,
poliestere alta tenacità (PES)

CE



UNI EN 1492-1

L m	H mm	WLL ton	U	U
0,5	30	1	1	081500005
1	30	1	1	081500010
1,5	30	1	1	081500015
2	30	1	1	081500020
2,5	30	1	1	081500025
3	30	1	1	081500030
4	30	1	1	081500040
5	30	1	1	081500050
6	30	1	1	081500060
8	30	1	1	081500080

8153

brache per sollevamento 2t verde
nastro piatto a due strati, asole rinforzate,
poliestere alta tenacità (PES)

CE



UNI EN 1492-1

L m	H mm	WLL ton	U	U
1	60	2	1	081530010
1,5	60	2	1	081530015
2	60	2	1	081530020
2,5	60	2	1	081530025
3	60	2	1	081530030
4	60	2	1	081530040
5	60	2	1	081530050
6	60	2	1	081530060
8	60	2	1	081530080
10	60	2	1	081530100

8156

brache per sollevamento 3t giallo
nastro piatto a due strati, asole rinforzate,
poliestere alta tenacità (PES)

CE

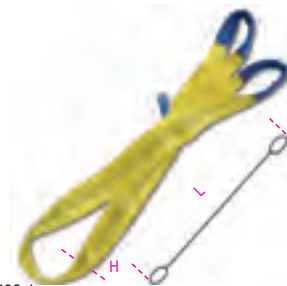

UNI EN 1492-1

L m	H mm	WLL ton	U	U
1	90	3	1	081560010
1,5	90	3	1	081560015
2	90	3	1	081560020
2,5	90	3	1	081560025
3	90	3	1	081560030
4	90	3	1	081560040
5	90	3	1	081560050
6	90	3	1	081560060
8	90	3	1	081560080
10	90	3	1	081560100
12	90	3	1	081560120



8157

brache per sollevamento 4t grigio
nastro piatto a due strati, asole rinforzate,
poliestere alta tenacità (PES)

CE



UNI EN 1492-1

L m	H mm	WLL ton	1	2
2	120	4	1	081570020
3	120	4	1	081570030
4	120	4	1	081570040
5	120	4	1	081570050
6	120	4	1	081570060
8	120	4	1	081570080
10	120	4	1	081570100
12	120	4	1	081570120

8158

brache per sollevamento 5t rosso
nastro piatto a due strati, asole rinforzate,
poliestere alta tenacità (PES)

CE



UNI EN 1492-1

L m	H mm	WLL ton	1	2
2	150	5	1	081580020
3	150	5	1	081580030
4	150	5	1	081580040
5	150	5	1	081580050
6	150	5	1	081580060
8	150	5	1	081580080
10	150	5	1	081580100
12	150	5	1	081580120

8159

brache per sollevamento 6t marrone
nastro piatto a due strati, asole rinforzate,
poliestere alta tenacità (PES)

CE



UNI EN 1492-1

L m	H mm	WLL ton	1	2
3	180	6	1	081590030
4	180	6	1	081590040
5	180	6	1	081590050
6	180	6	1	081590060
8	180	6	1	081590080
10	180	6	1	081590100



8160

brache per sollevamento 8t blu
nastro piatto a due strati, asole rinforzate,
poliestere alta tenacità (PES)

CE



UNI EN 1492-1

L m	H mm	WLL ton	1	2
3	240	8	1	081600030
5	240	8	1	081600050
6	240	8	1	081600060
8	240	8	1	081600080
10	240	8	1	081600100

8161

brache per sollevamento 10t arancio
nastro piatto a due strati, asole rinforzate,
poliestere alta tenacità (PES)

CE



UNI EN 1492-1

L m	H mm	WLL ton	1	2
4	300	10	1	081610040
5	300	10	1	081610050
6	300	10	1	081610060
8	300	10	1	081610080
10	300	10	1	081610100
12	300	10	1	081610120

8170

brache per sollevamento 1t
nastro ad anello continuo, viola
tessuto in poliestere ad alta tenacità (PES)

CE

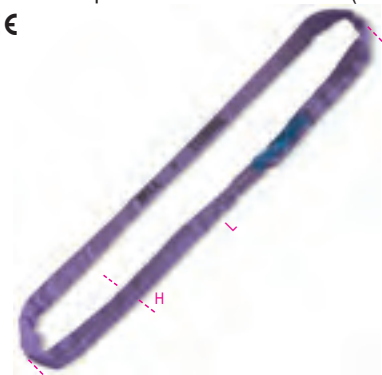

UNI EN 1492-2

L m	WLL ton	H mm	1	2
0,5	1	45	1	081700010
1	1	45	1	081700020
1,5	1	45	1	081700030
2	1	45	1	081700040
3	1	45	1	081700060
4	1	45	1	081700080



8173

brache per sollevamento 2t
nastro ad anello continuo, verde
tessuto in poliestere ad alta tenacità (PES)

CE

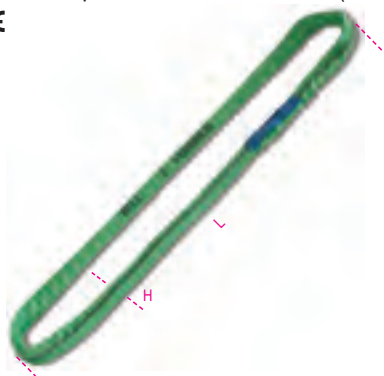

UNI EN 1492-2

L m	H mm	WLL ton		
0,5	50	2	1	081730010
1	50	2	1	081730020
1,5	50	2	1	081730030
2	50	2	1	081730040
2,5	50	2	1	081730050
3	50	2	1	081730060
4	50	2	1	081730080
5	50	2	1	081730100
6	50	2	1	081730120

8176

brache per sollevamento 3t
nastro ad anello continuo, giallo
tessuto in poliestere ad alta tenacità (PES)

CE



UNI EN 1492-2

L m	H mm	WLL ton		
1	60	3	1	081760020
1,5	60	3	1	081760030
2	60	3	1	081760040
2,5	60	3	1	081760050
3	60	3	1	081760060
4	60	3	1	081760080
5	60	3	1	081760100
6	60	3	1	081760120

8177

brache per sollevamento 4t
nastro ad anello continuo, grigio
tessuto in poliestere ad alta tenacità (PES)

CE



UNI EN 1492-2

L m	H mm	WLL ton		
1	65	4	1	081770020
1,5	65	4	1	081770030
2	65	4	1	081770040
2,5	65	4	1	081770050
3	65	4	1	081770060
4	65	4	1	081770080
5	65	4	1	081770100
6	65	4	1	081770120
8	65	4	1	081770160

8178

brache per sollevamento 5t
nastro ad anello continuo, rosso
tessuto in poliestere ad alta tenacità (PES)

CE

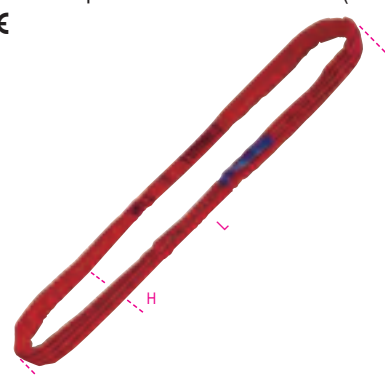

UNI EN 1492-2

L m	H mm	WLL ton		
1	70	5	1	081780020
1,5	70	5	1	081780030
2	70	5	1	081780040
2,5	70	5	1	081780050
3	70	5	1	081780060
4	70	5	1	081780080
5	70	5	1	081780100
6	70	5	1	081780120
8	70	5	1	081780160

8179M

brache per sollevamento 6t
nastro ad anello continuo, marrone
tessuto in poliestere ad alta tenacità (PES)

CE

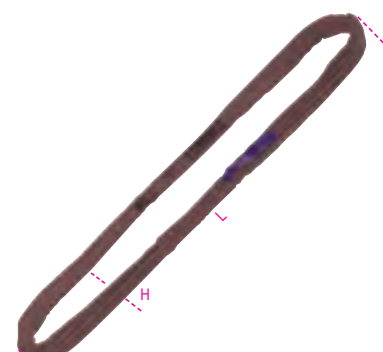

UNI EN 1492-2

L m	H mm	WLL ton		
3	80	6	1	081790060
4	80	6	1	081790080
6	80	6	1	081790120
8	80	6	1	081790160

8179B

brache per sollevamento 8t
nastro ad anello continuo, blu
tessuto in poliestere ad alta tenacità (PES)

CE

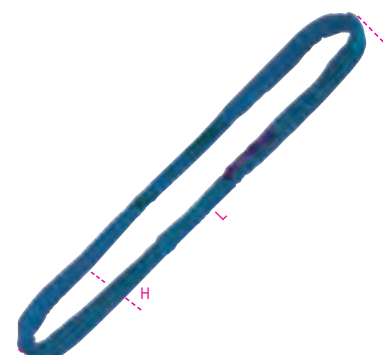

UNI EN 1492-2

L m	H mm	WLL ton		
3	85	8	1	081790260
4	85	8	1	081790280
6	85	8	1	081790320
8	85	8	1	081790360

8179A

brache per sollevamento 10t
nastro ad anello continuo, arancio
tessuto in poliestere ad alta tenacità (PES)

CE

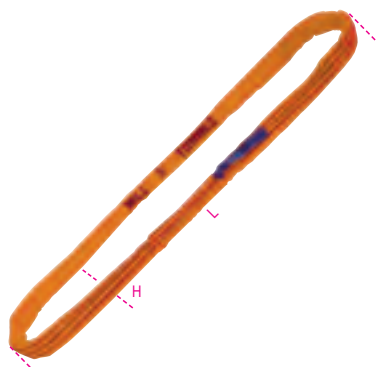

UNI EN 1492-2

L m	H mm	WLL ton		
3	95	10	1	081790506
4	95	10	1	081790508
6	95	10	1	081790512
8	95	10	1	081790516
10	95	10	1	081790520

8166

guaine antiabrasione per brache di
sollevamento,
in poliestere ad alta tenacità (PES)
con sottostrato elastomerico



H mm	ø mm	L m		
70	45	3	1	081660073
80	52	3	1	081660083
110	70	3	1	081660103
155	100	3	1	081660153
170	110	3	1	081660170

SISTEMI DI ANCORAGGIO E LEGATURA

UNI EN 12195

DATI TECNICI

- coefficiente di sicurezza: 2
- codice di identificazione

ANALISI DI LABORATORIO

- test pretensionabilità cricchetto
- test di deformazione parti metalliche
- test di trazione sistema completo

CERTIFICATI DISPONIBILI

- Specifica Prodotto
- Rapporto di Prova tipo 2.2 UNI EN10204

8180

sistemi di ancoraggio a cricchetto LC 750kg
nastro in poliestere ad alta tenacità (PES)
ganci a uncino



EN 12195-2

L m	L2 mm	L1 mm		
4	3750	250	1	081800004
6	5750	250	1	081800006
8	7750	250	1	081800008

LC = 750 kg

8181

sistemi di ancoraggio a cricchetto LC 1000kg
nastro in poliestere ad alta tenacità (PES)
ganci a uncino

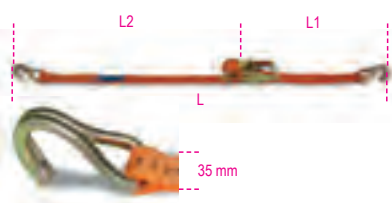

EN 12195-2

L m	L2 mm	L1 mm		
4	3600	400	1	081810004
6	5600	400	1	081810006
8	7600	400	1	081810008

LC = 1000 kg

8182

sistemi di ancoraggio a cricchetto LC 2000kg
nastro in poliestere ad alta tenacità (PES)
ganci a uncino

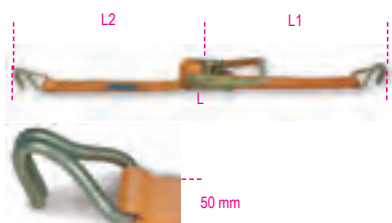

EN 12195-2

L m	L2 mm	L1 mm		
6,5	6100	400	1	081820065
8,5	8100	400	1	081820085
10,5	10100	400	1	081820105
14,5	14100	400	1	081820145

LC = 2000 kg

	L2 mm	L1 mm		
8182LP parte lunga	8100		1	081820902
8182SP parte corta e cricchetto		400	1	081820905

8182S

sistemi di ancoraggio a cricchetto LC 2000kg
nastro in poliestere ad alta tenacità (PES)
ganci sponda

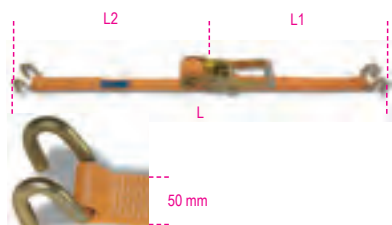

EN 12195-2

L m	L2 mm	L1 mm		
8,5	8100	400	1	081820285
10,5	10100	400	1	081820305

LC = 2000 kg

	L2 mm	L1 mm		
8182SLP parte lunga	8100		1	081820912
8182SSP parte corta e cricchetto		400	1	081820915



8182A

sistemi di ancoraggio a cricchetto con 2 sole
nastro in poliestere ad alta tenacità (PES)
LC 2000kg



EN 12195-2

L m	L2 mm	L1 mm		
8,5	8100	400	1	081820585

LC = 2000 kg

8182E

sistemi di ancoraggio a cricchetto per interni
furgoni e autocarri, LC 1000kg
nastro in poliestere ad alta tenacità (PES)

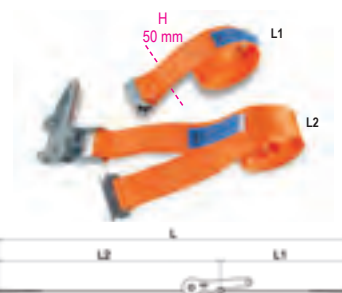

EN 12195-2

L m	L2 mm	L1 mm	H mm		
4	3500	500	50	1	081820440

LC = 1000 kg

	L2 mm	L1 mm		
8182EL	2500		1	081820942
8182EC		1500	1	081820945



8185

sistemi di ancoraggio ad anello LC 1500kg
con cricchetto tenditore
nastro in poliestere ad alta tenacità (PES)

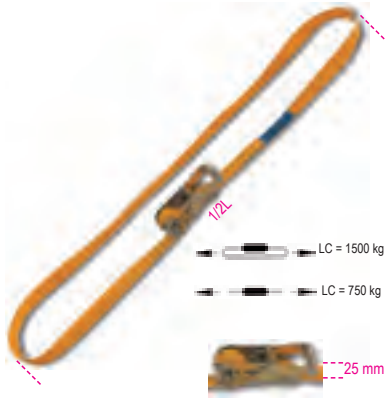

EN 12195-2

L m		
5	1	081850005
8	1	081850008

8186

sistemi di ancoraggio ad anello LC 2000kg
con cricchetto tenditore
nastro in poliestere ad alta tenacità (PES)



EN 12195-2

L m		
5	1	081860005
8	1	081860008

8187

sistemi di ancoraggio ad anello LC 4000kg
con cricchetto tenditore
nastro in poliestere ad alta tenacità (PES)

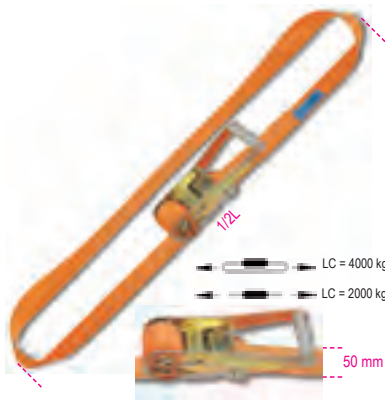

EN 12195-2

L m		
5	1	081870005
8	1	081870008

8188F

sistemi di legatura ad anello LC 200kg
con fibbia di serraggio
nastro in polipropilene ad alta tenacità (PP)

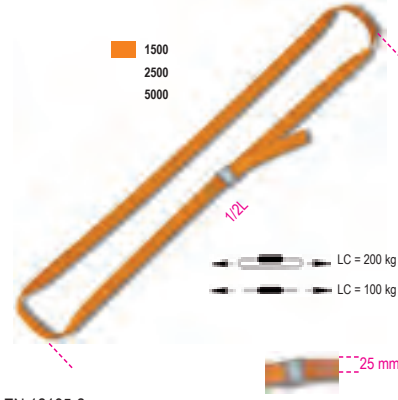

EN 12195-2

L m		
1,5	10	081880215
2,5	10	081880225
5,0	6	081880250



8188F/35

sistemi di legatura ad anello LC 500kg
con fibbia di serraggio
nastro in polipropilene ad alta tenacità (PP)

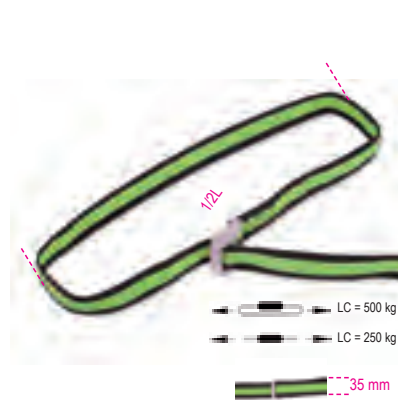

EN 12195-2

L m		
4	3	081881290



8188C

sistemi di legatura ad anello LC 750kg
con cricchetto tenditore
nastro in poliestere ad alta tenacità (PES)

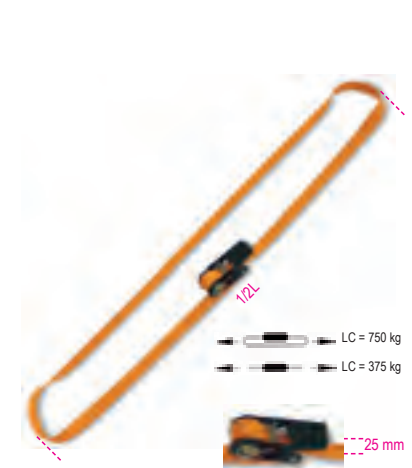

EN 12195-2

L m		
5	3	081880350



8188CG/25

sistemi di legatura con 2 ganci ed asole,
cricchetto tenditore LC 375kg
nastro in poliestere ad alta tenacità (PES)



EN 12195-2

L m	L1 mm	L2 mm		
3	480	170	1	081880430
5	480	170	1	081880450

8188FG2

sistemi di legatura con 2 ganci ed asole,
fibbia di serraggio LC 250kg
nastro in polipropilene ad alta tenacità (PP)



EN 12195-2

L	L1	L2		
m	mm	mm		
3	450	110	1	081881530

8188FG3

sistemi di legatura con 3 ganci ed asole,
fibbia di serraggio LC 250kg
nastro in polipropilene ad alta tenacità (PP)

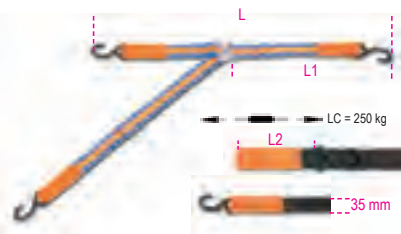

L max	L min	L1	L2		
m	m	mm	mm		
3,5	0,85	450	110	1	081880630

8189

nastro di legatura
poliester (PES), in rotoli
pezze con lunghezza variabile: minima continua garantita 30m



H	L	LC		
mm	m	kg		
25	100	750	1	081890902
35	100	1000	1	081890903
50	100	2000	1	081890905

8189PA

2 protezioni angolari
per nastri di ancoraggio in poliester



L1xL2	H1	H2		
mm	mm	mm		
100x60	60	12	1	081890060
135x90	60	18	1	081890090



Forze di rottura (BF)
indicata sulle specifiche
tecniche online
WWW.ROBURITALY.COM

8201T

canaile a tubo
inox AISI 316



ANALISI DI LABORATORIO
• analisi chimica
• test di trazione
CERTIFICATI DISPONIBILI
• Specifica Prodotto
• Rapporto di Prova tipo 2.2 UNI EN10204

Ø	Ø	WFL	L		
mm	"	kg	mm		
M6	1/4	160	95	5	082010406
M8	5/16	300	105	5	082010408
M10	3/8	470	125	3	082010410
M12	1/2	690	150	3	082010412
M14	9/16	940	165	1	082010414
M16	5/8	1290	190	1	082010416
M20	3/4	2130	210	1	082010420

8205

tenditore a due occhi
inox AISI 316

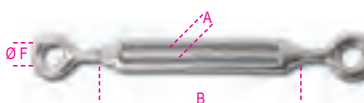

ANALISI DI LABORATORIO
• analisi chimica
• test di trazione
CERTIFICATI DISPONIBILI
• Specifica Prodotto
• Rapporto di Prova tipo 2.2 UNI EN10204

A	B	ØF	WFL		
mm	mm	mm	kg		
M4	62	8	75	10	082050204
M5	72	11	115	10	082050205
M6	92	12	160	5	082050206
M8	122	14	300	5	082050208
M10	150	16	470	1	082050210
M12	201	18	690	1	082050212
M14	225	22	940	1	082050214
M16	244	26	1290	1	082050216
M20	295	29	2130	1	082050220
M24	350	33	3000	1	082050224

8206

tenditore ad occhio e gancio
inox AISI 316

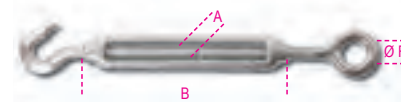

ANALISI DI LABORATORIO
• analisi chimica
• test di trazione
CERTIFICATI DISPONIBILI
• Specifica Prodotto
• Rapporto di Prova tipo 2.2 UNI EN10204

A	B	ØF	WFL		
mm	mm	mm	kg		
M5	72	11	25	10	082060205
M6	92	12	45	5	082060206
M8	122	14	95	5	082060208
M10	150	16	140	1	082060210
M12	201	18	300	1	082060212
M14	225	22	420	1	082060214
M16	244	26	570	1	082060216
M20	295	29	875	1	082060220

8207

tenditore a due ganci
inox AISI 316

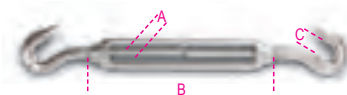

ANALISI DI LABORATORIO
• analisi chimica
• test di trazione
CERTIFICATI DISPONIBILI
• Specifica Prodotto
• Rapporto di Prova tipo 2.2 UNI EN10204

A	B	C	WFL		
mm	mm	mm	kg		
M5	72	9	25	10	082070205
M6	92	9	45	5	082070206
M8	122	10	95	5	082070208
M10	150	12	140	1	082070210
M12	201	14	300	1	082070212
M14	225	15	420	1	082070214
M16	244	16	570	1	082070216
M20	295	19	875	1	082070220

8209

tenditore a due forcelle
inox AISI 316

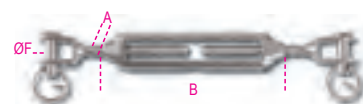

ANALISI DI LABORATORIO
• analisi chimica
• test di trazione
CERTIFICATI DISPONIBILI
• Specifica Prodotto
• Rapporto di Prova tipo 2.2 UNI EN10204

A	B	ØF	WFL		
mm	mm	mm	kg		
M5	72	5	115	5	082090205
M6	92	6	160	5	082090206
M8	122	8	300	5	082090208
M10	150	10	470	1	082090210
M12	201	12	690	1	082090212
M14	225	14	940	1	082090214
M16	244	16	1290	1	082090216
M20	295	20	2130	1	082090220
M24	350	24	3060	1	082090224

8210

tenditore a due forcelle con canaula a tubo
inox AISI 316

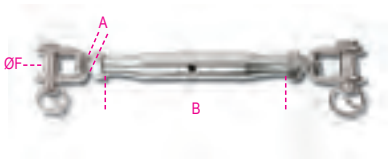

ANALISI DI LABORATORIO

- analisi chimica
 - test di trazione
- CERTIFICATI DISPONIBILI**
- Specifica Prodotto
 - Rapporto di Prova tipo 2.2 UNI EN10204

A mm	B mm	ØF mm	WFL kg		
M5	81	5	115	3	082100205
M6	92	6	160	3	082100206
M8	112	8	300	1	082100208
M10	121	10	470	1	082100210
M12	150	12	690	1	082100212
M14	169	14	940	1	082100214
M16	190	16	1290	1	082100216
M20	220	20	2130	1	082100220

8216

morsetti
inox AISI 316

CE



ANALISI DI LABORATORIO

- analisi chimica
 - test coppia di serraggio
- CERTIFICATI DISPONIBILI**
- Specifica Prodotto
 - Rapporto di Prova tipo 2.2 UNI EN10204
 - Certificato di Conformità CE

ØF mm	"	T	N		
2	5/64	80	3	15	082160202
3	1/8	80	3	15	082160203
4	5/32	80	3	10	082160204
5	3/16	110	3	10	082160205
6	1/4	120	5	10	082160206
8	5/16	210	5	5	082160208
10	3/8	240	5	5	082160210
12-13	1/2	300	5	5	082160213
16	5/8	335	5	5	082160216
20	3/4	540	5	5	082160220
22	7/8	595	7	3	082160222

8220

radance, tipo pesante
inox AISI 316

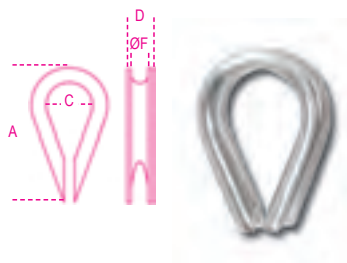

ANALISI DI LABORATORIO

- analisi chimica
- CERTIFICATI DISPONIBILI**
- Specifica Prodotto
 - Rapporto di Prova tipo 2.2 UNI EN10204

ØF mm	D mm	A mm	C mm		
2	4,5	21	7,5	15	082200202
3	6	24	10	15	082200203
4	6,6	28	11	10	082200204
5	8,5	30	13	10	082200205
6	10	37	15	10	082200206
8	12,5	51	23	5	082200208
10	14,6	56	27	5	082200210
12	18	68	32	5	082200212
14	19	69	34	5	082200214
16	22	83	37	5	082200216
18	23	81	38	1	082200218
20	27,8	105	45	1	082200220
22	29,6	112	45	1	082200222

8225

grilli diritti
inox AISI 316



ANALISI DI LABORATORIO

- analisi chimica
 - test di trazione
- CERTIFICATI DISPONIBILI**
- Specifica Prodotto
 - Rapporto di Prova tipo 2.2 UNI EN10204

ØD mm	"	A mm	WFL kg		
4	5/32	8	50	10	082250204
5	3/16	11	70	10	082250205
6	1/4	13	100	5	082250206
8	5/16	17	250	5	082250208
10	3/8	21	400	3	082250210
12	1/2	25	600	3	082250212
16	5/8	32	1000	1	082250216
19	3/4	38	1600	1	082250219
22	7/8	43	2000	1	082250222
25	1	46	2800	1	082250225

8227

grilli diritti lunghi
inox AISI 316

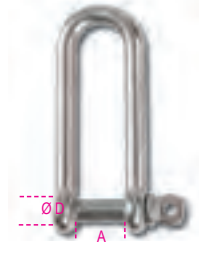

ANALISI DI LABORATORIO

- analisi chimica
 - test di trazione
- CERTIFICATI DISPONIBILI**
- Specifica Prodotto
 - Rapporto di Prova tipo 2.2 UNI EN10204

ØD mm	"	A mm	WFL kg		
4	5/32	8	50	10	082270204
5	3/16	10	70	10	082270205
6	1/4	13,5	100	5	082270206
8	5/16	17	250	5	082270208
10	3/8	21	400	1	082270210
12	1/2	25	600	1	082270212

8228

grilli a lira
inox AISI 316

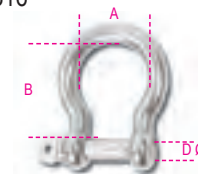

ANALISI DI LABORATORIO

- analisi chimica
 - test di trazione
- CERTIFICATI DISPONIBILI**
- Specifica Prodotto
 - Rapporto di Prova tipo 2.2 UNI EN10204

ØD mm	A mm	B mm	WFL kg		
4	13	20	60	10	082280204
5	17	23	80	10	082280205
6	20	27	100	10	082280206
8	28	36	200	5	082280208
10	36	44	300	5	082280210
12	41	53	500	5	082280212
16	54	74	800	1	082280216
19	66	86	1100	1	082280219

8240

golfari maschio,
inox AISI 316



ANALISI DI LABORATORIO

- analisi chimica
 - test di trazione
- CERTIFICATI DISPONIBILI**
- Specifica Prodotto
 - Rapporto di Prova tipo 2.2 UNI EN10204

A mm	B mm	ØC mm	WFL kg		
M6	41	15	75	10	082400206
M8	50	20	140	10	082400208
M10	62	25	230	5	082400210
M12	74	30	340	5	082400212

8242

golfari femmina,
inox AISI 316



A	B	ØC	WFL		
mm	mm	mm	kg		
M6	27	15	75	10	082420206
M8	36	20	140	10	082420208
M10	45	25	230	5	082420210
M12	55	30	340	5	082420212

8240F

golfari per sollevamento inox A4
maschio, FORGIATI

CE



DATI TECNICI

- coefficiente di sicurezza: 6
 - codice lotto di fabbricazione
- ANALISI DI LABORATORIO**
- analisi chimica
 - analisi metallografica
 - test di trazione
- CERTIFICATI DISPONIBILI**
- Specifica Prodotto
 - Rapporto di Prova tipo 2.2 UNI EN10204
 - Certificato di Controllo tipo 3.1 UNI EN10204
 - Dichiarazione di Conformità CE

Ø	WFL		
mm	kg		
* M8	1,25	200	4 082400408
* M10	1,5	400	4 082400410
* M12	1,75	600	4 082400412
* M14	2	1000	2 082400414
* M16	2	1200	2 082400416
* M20	2,5	2000	2 082400420
* M24	3	2700	2 082400424
* M30	3,5	4000	1 082400430

(* Caratteristiche dimensionali DIN 580:2010
WLL incrementato in base a Fascicolo Tecnico Robur
(garantito per accoppiamenti inox-inox)

8242F

golfari per sollevamento inox A4
femmina, FORGIATI

CE



DATI TECNICI

- coefficiente di sicurezza: 6
 - codice lotto di fabbricazione
- ANALISI DI LABORATORIO**
- analisi chimica
 - analisi metallografica
 - test di trazione
- CERTIFICATI DISPONIBILI**
- Specifica Prodotto
 - Rapporto di Prova tipo 2.2 UNI EN10204
 - Certificato di Controllo tipo 3.1 UNI EN10204
 - Dichiarazione di Conformità CE

Ø	WFL		
mm	kg		
* M8	1,25	200	4 082420408
* M10	1,5	400	4 082420410
* M12	1,75	600	4 082420412
* M14	2	1000	2 082420414
* M16	2	1200	2 082420416
* M20	2,5	2000	2 082420420
* M24	3	2700	2 082420424
* M30	3,5	4000	1 082420430

(* Caratteristiche dimensionali DIN 582:2010
WLL incrementato in base a Fascicolo Tecnico Robur
(garantito per accoppiamenti inox-inox)

8248

tiranti ad occhio
INOX 316L
destri



UNI 6058

CERTIFICATI DISPONIBILI

- Specifica Prodotto
- Rapporto di Prova tipo 2.2 UNI EN10204

ØxL	F		
mm	mm		
10x80	8	1	082480010
10x130	8	1	082480012
12x95	10	1	082480016
12x125	10	1	082480018

8249

viti ad occhio per tasselli
inox AISI 316



ANALISI DI LABORATORIO

- analisi chimica
 - test di trazione
- CERTIFICATI DISPONIBILI**
- Specifica Prodotto
 - Rapporto di Prova tipo 2.2 UNI EN10204

A	ØB	D	WFL		
mm	mm	mm	kg		
M5	11	50	100	10	082490205
M6	13	55	160	10	082490206
M8	17	60	300	5	082490208
M10	21	80	470	5	082490210
M12	25	120	690	1	082490212

8249G

ganci per tasselli
inox AISI 316



ANALISI DI LABORATORIO

- analisi chimica
 - test di trazione
- CERTIFICATI DISPONIBILI**
- Specifica Prodotto
 - Rapporto di Prova tipo 2.2 UNI EN10204

A	E	ØF	WFL		
mm	mm	mm	kg		
M5	39	9	25	5	082490305
M6	43	10,5	45	5	082490306
M8	57	14,5	95	3	082490308

8250

moschettoni a gancio con sicura
inox AISI 316



ANALISI DI LABORATORIO

- analisi chimica
 - test di trazione
- CERTIFICATI DISPONIBILI**
- Specifica Prodotto
 - Rapporto di Prova tipo 2.2 UNI EN10204

L	A	ØB	WFL		
mm	mm	mm	kg		
50	25	8	40	5	082500205
70	31	12,5	90	5	082500207
100	47	20	190	1	082500210

8264

moschettoni a girello
inox AISI 316



ANALISI DI LABORATORIO

- analisi chimica
 - test di trazione
- CERTIFICATI DISPONIBILI**
- Specifica Prodotto
 - Rapporto di Prova tipo 2.2 UNI EN10204

B	L	C	WFL		
mm	mm	mm	kg		
12	88	12	60	5	082640212
16	90	12	60	5	082640216
19	93	12	60	1	082640219
25	100	12	60	1	082640225



8267

moschettoni a gancio con girello e sicura
inox AISI 316



ANALISI DI LABORATORIO

- analisi chimica
 - test di trazione
- CERTIFICATI DISPONIBILI
- Specifica Prodotto
 - Rapporto di Prova tipo 2.2 UNI EN10204

A	L	B	WFL		
mm	mm	mm	kg		
10	87	21	30	5	082670210
12	118	22	70	1	082670213

8272

girelli a due occhi
inox AISI 316

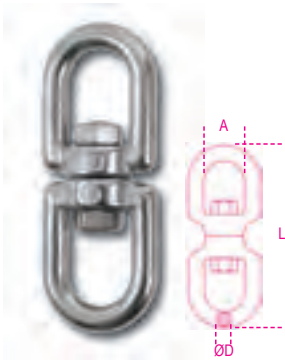

ANALISI DI LABORATORIO

- analisi chimica
 - test di trazione
- CERTIFICATI DISPONIBILI
- Specifica Prodotto
 - Rapporto di Prova tipo 2.2 UNI EN10204

Ø D	A	L	WFL		
mm	mm	mm	kg		
4	11	50	90	5	082720204
5	13	60	115	5	082720205
6	15	66	140	5	082720206
8	19	90	250	3	082720208
10	23	112	300	1	082720210
13	33	148	650	1	082720213
16	38	184	1000	1	082720216
19	40	223	1600	1	082720219

8273

moschettoni a sgancio rapido
con occhio girevole
inox AISI 316



ANALISI DI LABORATORIO

- analisi chimica
 - test di trazione
- CERTIFICATI DISPONIBILI
- Specifica Prodotto
 - Rapporto di Prova tipo 2.2 UNI EN10204

Ø C x L	B	WFL	BF		
mm	mm	kg	kg		
12x70	12	230	1100	1	082730012
16x85	14,5	440	2000	1	082730016
22x120	20	700	3500	1	082730022

8274

moschettoni
inox AISI 316

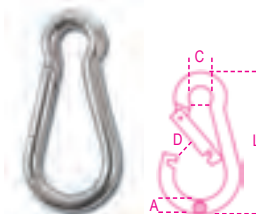

ANALISI DI LABORATORIO

- analisi chimica
 - test di trazione
- CERTIFICATI DISPONIBILI
- Specifica Prodotto
 - Rapporto di Prova tipo 2.2 UNI EN10204

Ø A x L	Ø C	D	WFL		
mm	mm	mm	kg		
4,5x40	6,5	6	20	10	082740204
5x50	8	7	30	10	082740205
6x60	8,5	7,5	40	5	082740206
7x70	10	9	60	5	082740207
8x80	12	10	75	5	082740208
9x90	12,5	10,5	100	5	082740209
10x100	15	13	120	1	082740210
11x120	19	18	140	1	082740211
12x140	22	21	140	1	082740212
13x160	22	26	200	1	082740213

8274A

moschettoni con anello
inox AISI 316

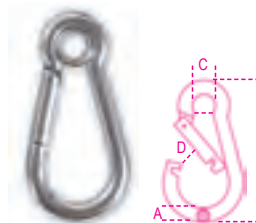

ANALISI DI LABORATORIO

- analisi chimica
 - test di trazione
- CERTIFICATI DISPONIBILI
- Specifica Prodotto
 - Rapporto di Prova tipo 2.2 UNI EN10204

Ø A x L	Ø C	D	WFL		
mm	mm	mm	kg		
5x50	6,5	7	30	10	082740405
6x60	7,5	7,5	40	5	082740406
8x80	9,5	10	75	5	082740408

8274G

moschettoni con ghiera
inox AISI 316

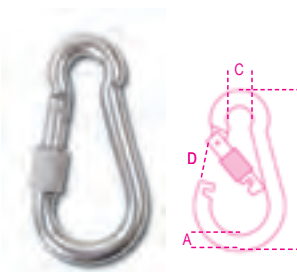

ANALISI DI LABORATORIO

- analisi chimica
 - test di trazione
- CERTIFICATI DISPONIBILI
- Specifica Prodotto
 - Rapporto di Prova tipo 2.2 UNI EN10204

Ø A x L	Ø C	D	WFL		
mm	mm	mm	kg		
6x60	8,5	6,5	40	5	082740306
8x80	12	8,5	75	5	082740308
10x100	15	12	120	3	082740310

8276

moschettoni asimmetrici
inox AISI 316

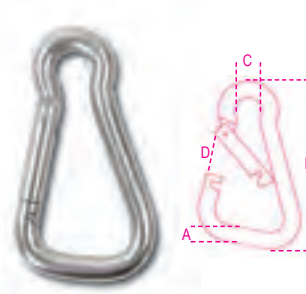

ANALISI DI LABORATORIO

- analisi chimica
 - test di trazione
- CERTIFICATI DISPONIBILI
- Specifica Prodotto
 - Rapporto di Prova tipo 2.2 UNI EN10204

Ø A x L	Ø C	D	WFL		
mm	mm	mm	kg		
6x60	8,5	10	40	5	082760206
8x80	12	14	75	5	082760208
10x100	15	18	120	3	082760210

8276G

moschettoni asimmetrici con ghiera
inox AISI 316

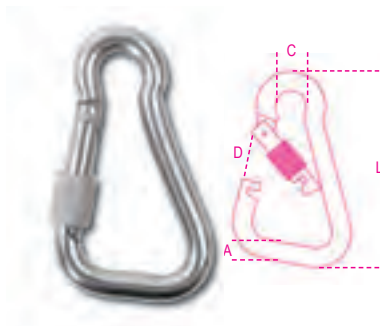

ANALISI DI LABORATORIO

- analisi chimica
 - test di trazione
- CERTIFICATI DISPONIBILI
- Specifica Prodotto
 - Rapporto di Prova tipo 2.2 UNI EN10204

ø A x L	ø C	D	WFL		
mm	mm	mm	kg		
6x60	8,5	9	40	3	082760306
8x80	12	12,5	75	3	082760308
10x100	15	16	120	3	082760310

8278

moschettoni trapezoidali
inox AISI 316

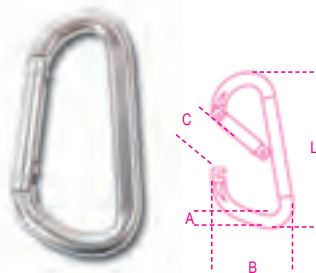

ANALISI DI LABORATORIO

- analisi chimica
 - test di trazione
- CERTIFICATI DISPONIBILI
- Specifica Prodotto
 - Rapporto di Prova tipo 2.2 UNI EN10204

ø A x L	B	C	WFL		
mm	mm	mm	kg		
8x80	45	14	75	3	082780208
10x100	55	16	120	3	082780210

8280

maglie di giunzione
inox AISI 316

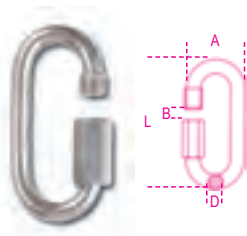

ANALISI DI LABORATORIO

- analisi chimica
 - test di trazione
- CERTIFICATI DISPONIBILI
- Specifica Prodotto
 - Rapporto di Prova tipo 2.2 UNI EN10204

ø D x L	A	B	WFL		
mm	mm	mm	kg		
3,5x35	17	5	20	10	082800203
4x40	19	6	30	10	082800204
5x50	23	7	50	5	082800205
6x60	26	8	60	5	082800206
7x70	30	9	100	5	082800207
8x80	33	10	140	1	082800208
10x90	40	12	220	1	082800210
12x100	47	14	300	1	082800212

8282

ganci a "S"
inox AISI 316

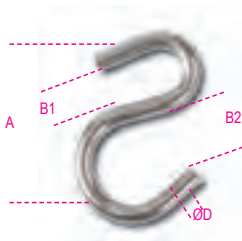

ANALISI DI LABORATORIO

- analisi chimica
 - test di trazione
- CERTIFICATI DISPONIBILI
- Specifica Prodotto
 - Rapporto di Prova tipo 2.2 UNI EN10204

ø D	A	B1	B2		
mm	mm	mm	mm		
3	31	7,5	14	10	082820203
4	37	10,5	14,5	10	082820204
5	44	12,5	16	10	082820205
6	51	12,5	18	5	082820206
8	68	14	23	5	082820208

8284

moschettoni a pellicano
inox AISI 316



ANALISI DI LABORATORIO

- analisi chimica
 - test di trazione
- CERTIFICATI DISPONIBILI
- Specifica Prodotto
 - Rapporto di Prova tipo 2.2 UNI EN10204

ø C	B	L	WFL		
mm	mm	mm	kg		
6	11	73	200	3	082840006
8	14	98	300	3	082840008
10	23	143	450	1	082840010

8285

terminali a forcella
inox AISI 316

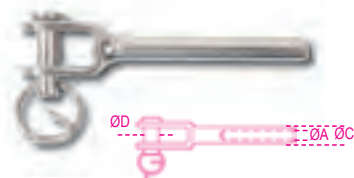

ANALISI DI LABORATORIO

- analisi chimica
 - test di trazione
- CERTIFICATI DISPONIBILI
- Specifica Prodotto
 - Rapporto di Prova tipo 2.2 UNI EN10204

ø A	ø C	ø D	WFL		
mm	mm	mm	kg		
3	6,3	6	180	5	082850203
4	7,5	6	200	3	082850204
5	9	10	330	1	082850205
6	12,5	12	720	1	082850206
8	16	13	1120	1	082850208

8286

terminali ad occhio
inox AISI 316



ANALISI DI LABORATORIO

- analisi chimica
 - test di trazione
- CERTIFICATI DISPONIBILI
- Specifica Prodotto
 - Rapporto di Prova tipo 2.2 UNI EN10204

ø D	ø A	ø C	WFL		
mm	mm	mm	kg		
3	6,5	6,3	180	5	082860203
4	8,5	7,5	200	3	082860204
5	10,6	9	330	1	082860205
6	13	12,5	720	1	082860206
8	14,7	16	1120	1	082860208

8287

terminali a tubo
inox AISI 316

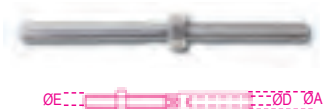

ANALISI DI LABORATORIO

- analisi chimica
- test di trazione
- CERTIFICATI DISPONIBILI
- Specifica Prodotto
- Rapporto di Prova tipo 2.2 UNI EN10204

ø D	ø A	E	WFL		
mm	mm	mm	kg		
3	6,3	M6	180	5	082870203
4	7,5	M8	200	3	082870204
5	9	M10	330	1	082870205
6	12,5	M12	720	1	082870206
8	16	M16	1120	1	082870208

8290

ponticelli
inox AISI 316



ANALISI DI LABORATORIO

- analisi chimica
- CERTIFICATI DISPONIBILI
- Specifica Prodotto
- Rapporto di Prova tipo 2.2 UNI EN10204

ø A	B	ø C	L		
mm	mm	mm	mm		
5	18	4,3	40	5	082900205
6	22	5,2	44	5	082900206
8	23	5,2	51	5	082900208

8381SX

collari per sostegno tubazioni,
acciaio inox

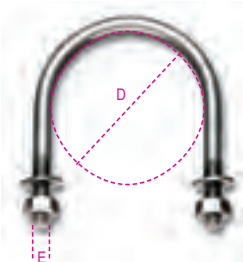

AISI 304

ANALISI DI LABORATORIO

- analisi chimica
- CERTIFICATI DISPONIBILI
- Rapporto di Prova tipo 2.2 UNIEN10204

D	D	E		
mm	gas	mm		
11	1/8"	M6	20	083810401
14	1/4"	M6	20	083810402
18	3/8"	M6	20	083810403
22	1/2"	M6	20	083810404
27	3/4"	M6	20	083810405
34	1"	M6	20	083810406
43	1 1/4"	M6	20	083810407
49	1 1/2"	M8	10	083810408
61	2"	M8	10	083810409
77	2 1/2"	M8	10	083810410
89	3"	M8	10	083810412
115	4"	M8	10	083810413

8293

sistemi di legatura a cricchetto AISI 304
nastro in poliestere ad alta tenacità LC 300kg
ganci uncino

in confezione appendibile

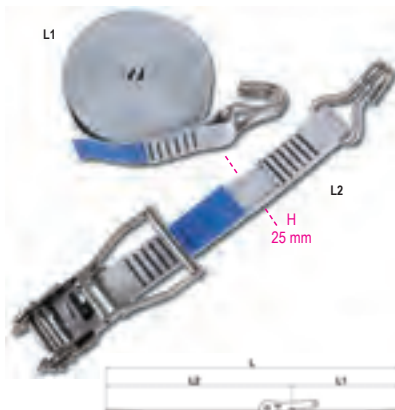

L	L2	L1		
m	mm	mm		
6	5700	300	1	082930106

LC = 300 kg

8297C

sistemi di legatura ad anello
con mini cricchetto AISI 304
nastro in poliestere ad alta tenacità LC 700kg

in confezione appendibile

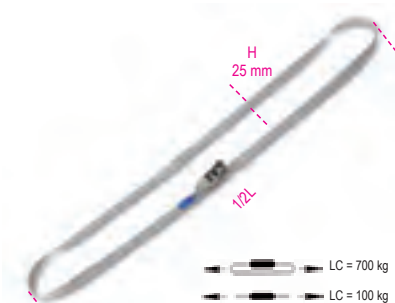

L	H		
m	mm		
5	25	1	082970350

LC = 700 kg

8297F

2 sistemi di legatura ad anello
con fibbia AISI 304
nastro in poliestere ad alta tenacità LC 250kg

in confezione appendibile

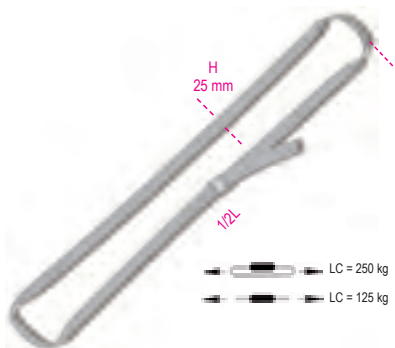

L	H		
m	mm		
3	25	1	082970230

LC = 250 kg



8001Z-K

CE



Ø mm		
M5	2	080019105
M6	2	080019106
M8	1	080019108
M10	1	080019110
M11	1	080019111
M12	1	080019112
M14	1	080019114
M16	1	080019116
M18	1	080019118
M20	1	080019120
M22	1	080019122
M24	1	080019124

8001TZ-K

CE



Ø mm		
M12	1	080019512
M16	1	080019516
M20	1	080019520
M24	1	080019524

8005Z-K

CE



Ø mm		
M5	2	080059105
M6	2	080059106
M8	1	080059108
M10	1	080059110
M11	1	080059111
M12	1	080059112
M14	1	080059114
M16	1	080059116

8005TZ-K

CE



Ø mm		
M12	1	080059512

8006Z-K

CE



Ø mm		
M5	2	080069105
M6	2	080069106
M8	1	080069108
M10	1	080069110
M11	1	080069111
M12	1	080069112
M14	1	080069114

8007Z-K

CE



Ø mm		
M5	2	080079105
M6	2	080079106
M8	1	080079108
M10	1	080079110
M11	1	080079111
M12	1	080079112

8008N-K

CE



Ø mm		
M5	2	080089205
M6	2	080089206
M8	1	080089208
M10	1	080089210
M12	1	080089212
M14	1	080089214

8009Z-K

CE



Ø mm		
M8	1	080099008
M10	1	080099010
M12	1	080099012

8009TZ-K

CE



Ø mm		
M12	1	080099512

8010Z-K

CE



Ø mm		
M8	1	080109008
M10	1	080109010
M12	1	080109012
M14	1	080109014

8105-K

CE



ØxE "		
3/8x6	1	081059010
1/2x9	1	081059012

8109-K

CE



ØxE "		
3/8x6	1	081099010
1/2x9	1	081099012

8016-K

CE



Ø mm		
3	6	080169003
5	4	080169005
6	4	080169006
8	4	080169008

Ø mm		
10	2	080169010
11	1	080169011
12-13	1	080169013
14	1	080169014
16	1	080169016
18	1	080169018
20	1	080169020
22	1	080169022
24-26	1	080169026

8016FR-K

CE



Ø mm		
3	6	080169253
5	4	080169255
6	4	080169256
8	4	080169258
10	2	080169260
12-13	1	080169263

8016U-K

CE



Ø mm		
5	4	080169605
6,5	4	080169606
8	4	080169608
10	2	080169610
12	1	080169612
14	1	080169614
16	1	080169616
19	1	080169619
22	1	080169622
26	1	080169626

8025-K

CE



Ø mm		
5	4	080259005
6	4	080259006
8	2	080259008
10	2	080259010
11	1	080259011
12	1	080259012
14	1	080259014
16	1	080259016
18	1	080259018
20	1	080259020
22	1	080259022
25	1	080259025

Robur

8026A-K

CE



Ø mm		
12	1	080269012
14	1	080269014
16	1	080269016
18	1	080269018
20	1	080269020
22	1	080269022
25	1	080269025

8026R-K

CE



ØA mm		
13	1	080269212
16	1	080269216

8028-K

CE



Ø mm		
5	4	080289105
6	4	080289106
8	2	080289108
10	2	080289110
11	1	080289111
12	1	080289112
14	1	080289114
16	1	080289116
18	1	080289118
20	1	080289120
22	1	080289122

8029R-K

CE



ØD mm ("")		
8 (5/16)	1	080299106
10 (3/8)	1	080299108
11 (7/16)	1	080299110
13 (1/2)	1	080299111
16 (5/8)	1	080299112
19 (3/4)	1	080299116

8031R-K

CE



ØA mm		
13	1	080319112
16	1	080319116

8032-K

CE



ØA mm		
13	1	080329012
16	1	080329016

8040EN-K

CE



Ø mm		
* M6	4	080409306
M8	4	080409308
M10	2	080409310
M12	1	080409312
* M14	1	080409314
M16	1	080409316
* M18	1	080409318
M20	1	080409320
* M22	1	080409322
M24	1	080409324
* M27	1	080409327
M30	1	080409330

8040EZ-K

CE



Ø mm		
* M6	4	080409406
M8	4	080409408
M10	2	080409410
M12	1	080409412
* M14	1	080409414
M16	1	080409416
* M18	1	080409418
M20	1	080409420
* M22	1	080409422
M24	1	080409424
* M27	1	080409427
M30	1	080409430

8041-K

CE



Ø mm		
* M8	1	080419208
* M10	1	080419210
* M12	1	080419212

8042EN-K

CE



Ø mm		
* M6	4	080429306
M8	4	080429308
M10	2	080429310

Ø mm		
M12	1	080429312
* M14	1	080429314
M16	1	080429316
* M18	1	080429318
M20	1	080429320
* M22	1	080429322
M24	1	080429324
* M27	1	080429327
M30	1	080429330

8042EZ-K

CE



Ø mm		
* M6	4	080429406
M8	4	080429408
M10	2	080429410
M12	1	080429412
* M14	1	080429414
M16	1	080429416
* M18	1	080429418
M20	1	080429420
* M22	1	080429422
M24	1	080429424
* M27	1	080429427
M30	1	080429430

8043-K

CE



Ø mm		
* M8	1	080439208
* M10	1	080439210
* M12	1	080439212

8051S-K

CE



WLL kg		
250	1	080519202
500	1	080519205

8216-K

CE



Ø F mm		
2	4	082169202
3	4	082169203
4	4	082169204
5	2	082169205
6	2	082169206
8	2	082169208
10	1	082169210

Beta Collection

È una linea di prodotti esclusivi pensati e realizzati come espressione del carattere Beta che comprende oltre 200 creazioni originali di altissima qualità: attrezzature sportive, abbigliamento tecnico e una molteplicità di oggettistica personalizzata. Ideali per dar vita ad iniziative promozionali, e per trascorrere momenti di svago.



9572MB

t-shirt vintage Beta-March F1 100% cotone



S	1	095720701
M	1	095720702
L	1	095720703
XL	1	095720704
XXL	1	095720705

9504

softshell antivento/antipioggia, esterno nero/interno arancio, inserto tessuto arancio e grigio su una spalla, cerniere termonastrate, logo reflective e stampa sul retro.



S	1	095040001
M	1	095040002
L	1	095040003
XL	1	095040004

9505

softshell antivento/antipioggia senza maniche, esterno nero/interno arancio, inserto tessuto arancio e grigio su una spalla, cerniere termonastrate, logo reflective e stampa sul retro.



S	1	095050001
M	1	095050002
L	1	095050003
XL	1	095050004
XXL	1	095050005

9507U

felpa uomo in CVC cotone 60%, poliestere 40%, con cappuccio e zip lunga



M	1	095070052
L	1	095070053
XL	1	095070054
XXL	1	095070055

9507D

felpa donna in CVC cotone 60%, poliestere 40%, con cappuccio e zip lunga



S	1	095070061
M	1	095070062
L	1	095070063
XL	1	095070064

9508K

giacca con zip lunga in nylon ripstop, impermeabile, tascabile



S	1	095080011
M	1	095080012
L	1	095080013
XL	1	095080014

9510

camicia maniche corte in cotone popeline 100%, 110 gr, inserti tessuto arancio e piping bianco, bottone arancio in contrasto, logo reflective e stampa retro.



XS	1	095100000
S	1	095100001
M	1	095100002
L	1	095100003
XL	1	095100004
XXL	1	095100005

9533N

polo in poliestere traspirante, 175 g, colore nero



S	1	095330051
M	1	095330052
L	1	095330053
XL	1	095330054
XXL	1	095330055

9534W

polo 3 bottoni in cotone piquè cardato 200 g bianco



S	1	095340011
M	1	095340012
L	1	095340013
XL	1	095340014
XXL	1	095340015

9534B

polo 3 bottoni in cotone piquè cardato 200 g blu



S	1	095340051
M	1	095340052
L	1	095340053
XL	1	095340054
XXL	1	095340055

9535

t-shirt manica lunga doppia, in cotone 100% 180 g, con stampa ed applicazione sul fronte e patch ricamato su manica



S	1	095350011
M	1	095350012
L	1	095350013
XL	1	095350014

9537N

pile, nero 100% poliestere



M	1	095370102
L	1	095370103
XL	1	095370104
XXL	1	095370105

9564B

cravatta in poliestere, blu



9564S 1 095640011

9564G

cravatta in poliestere, grigia



9564P 1 095640021

9564X

cravatta slim in poliestere, bordeaux



9564X 1 095640031



9593CV

cronografo al quarzo, cassa in acciaio 42,5 mm, water resistant 5ATM, datario, cinturino in pelle



9593CV 1 095930115

9593CA

cronografo, cassa in acciaio, water resistant 5ATM, cinturino in pelle



9593 1 095930025

9593B

orologio analogico, cassa in plastica soft touch con ghiera in metallo, water resistant 3ATM, cinturino in silicone



9593B 1 095930130

9544

trolley rigido formato cabina



9544

1 095440100

9545

trolley porta PC



9545

1 095450100

9557J 2.0

borzone in poliestere spalmato/poliestere oxford 600D, dimensioni 47x28x25 cm



9557J 2.0

1 095570020

9557SB

borsa sport con scomparto portascarpe, poliestere spalmato/poliestere oxford 600D, dimensioni 46x21x37 cm



9557SB

1 095570050

9557N

borsa "Racing" realizzata in tessuto laminato PVC, totalmente impermeabile



cm
80x35x35

1 095570001

9541

zaino sport porta PC in poliestere 600D/PVC. Inserti in 1680D e 420D/PU



cm
43x39x16

1 095410000

9541F

zaino in poliestere spalmato/poliestere oxford 600D, dimensioni 50x33x16 cm



9541F

1 095410011

9541BIKE

zainetto in poliestere oxford, dimensioni 41x24x16 cm



9541BIKE

1 095410021

95740

guanti da lavoro



cm

M	1 095740202
L	1 095740203
XL	1 095740204
XXL	1 095740205

9574B

guanti da lavoro



cm

M	1 095740102
L	1 095740103
XL	1 095740104
XXL	1 095740105

Beta

9525C

cappellino in tessuto 100% poliestere traspirante tipo Ottoman, colore nero, taglia unica regolabile



9525C 5 095250051

9525R

cappellino in 100% poliestere traspirante, colore nero, taglia unica regolabile



9525R 5 095250071

9525/N

cappellino, 100% cotone, taglia unica regolabile, ricamo diretto sul frontale, sui lati e sul retro, nero



9525/N 5 095251021

9525/B

cappellino, 100% cotone, taglia unica regolabile, ricamo diretto sul frontale, sui lati e sul retro, bianco



9525/B 5 095251031

9521

ombrello in nylon T210 con fusto in alluminio 3 sezioni, automatico



9521 1 095210000

9521W

ombrello in nylon 210T, diametro 100 cm



9521W 1 095210111

9599CB

city bike Atala®, telaio in alluminio 49 cm, cambio Shimano® 6 velocità, freni V-brake®, cerchi in alluminio 28"



9599CB 1 095990011

9599CB-W

city bike Atala®, telaio in alluminio, cambio shimano® 6 velocità, freni V-Brake® cerchi in alluminio 28"



9599CB-W 1 095990023

9598A

mountain bike Atala®, telaio in alluminio con forcella ammortizzata con blocco meccanico, cambio Shimano® Acera 24 velocità, freni a disco idraulici, cerchi in alluminio 29"



9598A M 1 095980100
9598A L 1 095980102

9598B

mountain bike Whistle®, telaio in carbonio monoscocca con forcella Suntour con remote lock-out, cambio Shimano XT 20 velocità, deragliatore e comandi Deore, freni idraulici Shimano, cerchi in alluminio 27,5"



	H cm	
9598B S	160+170	1 095980198
9598B M	170+180	1 095980200
9598B L	180+195	1 095980202

9539C/B

casco bike per ciclismo, calotta esterna in policarbonato, interno in EPS nero alta densità, taglia regolabile 54-62 con rotella



M	1	095390000
L	1	095390001

9542

completo bike, maglia maniche corte in microfibra traspirante, zip lunga coperta, tre tasche posteriori, elastico in silicone a fondo maglia; salopette in lycra, elastico siliconato fondo gamba, fondello antibatterico ad alta traspirabilità



Dimensione	Quantità	Articolo
S	1	095420002
M	1	095420003
L	1	095420004
XL	1	095420005
XXL	1	095420006
XXXL	1	095420007

9542G

maglia invernale in tessuto traspirante, garzato internamente, zip lunga, tre tasche posteriori, elastico in silicone a fondo maglia



Dimensione	Quantità	Articolo
S	1	095420012
M	1	095420013
L	1	095420014
XL	1	095420015
XXL	1	095420016
XXXL	1	095420017

9542S

calzamaglia invernale in lycra garzata con fondello antibatterico ad alta traspirabilità



Dimensione	Quantità	Articolo
S	1	095420022
M	1	095420023
L	1	095420024
XL	1	095420025
XXL	1	095420026
XXXL	1	095420027

9542A

giubbino antivento senza maniche in tessuto accoppiato traspirante, zip lunga



Dimensione	Quantità	Articolo
S	1	095420032
M	1	095420033
L	1	095420034
XL	1	095420035
XXL	1	095420036
XXXL	1	095420037



9542AL

giubbino antivento in tessuto accoppiato traspirante, zip lunga



Dimensione	Quantità	Articolo
S	1	095420042
M	1	095420043
L	1	095420044
XL	1	095420045
XXL	1	095420046
XXXL	1	095420047

9543S

completo bike, maglia maniche corte in microfibra traspirante, zip lunga coperta, tre tasche posteriori, elastico in silicone a fondo maglia; salopette in lycra, elastico siliconato fondo gamba, fondello antibatterico ad alta traspirabilità



Dimensione	Quantità	Articolo
S	1	095430002
M	1	095430003
L	1	095430004
XL	1	095430005
XXL	1	095430006
XXXL	1	095430007

9543W

completo bike, maglia maniche corte in microfibra traspirante, zip lunga coperta, tre tasche posteriori, elastico in silicone a fondo maglia; salopette in lycra, elastico siliconato fondo gamba, fondello antibatterico ad alta traspirabilità, bianco



S	1	095430102
M	1	095430103
L	1	095430104
XL	1	095430105
XXL	1	095430106
XXXL	1	095430107

9597P

pompa a colonna con manometro



9597P 1 095970100

9524SC

garage Beta in miniatura per collezionisti



1:43	1	095240043
1:18	1	095240018

9547WSK

"Kinder Work Station", banco da lavoro con utensili per bambini a partire da 3 anni



9547WSK 1 095473801

9547T

"Kinder trolley", carrello attrezzi con utensili per bambini a partire da 3 anni



9547T 1 095470100

9560A

mini arco gonfiabile ad aria fredda dimensioni: interne mt 3,60x4,60 diam.92 colore arancione

A RICHIESTA



9560A 1 095600001

9562L

gazebo mt 3x3 - 1 lato aperto

A RICHIESTA



9562L 1 095620010

9562P

gazebo 3x3 m, chiuso con porta e finestre

A RICHIESTA



9562P 1 095620100

9561V

bandiera a vela mt 4x0,75 con asta in metallo cromato basamento in graniglia di cemento 50 cm



9561V 1 095610001

 **Beta**

9559striscione monofacciale in TNT,
modulo da 3x0,8 m o multipli

9559

1 095591001

9559/30MT

rotolo 10 loghi beta in TNT



9559/30MT

1 095591031

9590B

bandiera in nylon serigrafato



9590B

1 095900000

9582LE

insegna luminosa monofacciale da esterni



9582LE

1 095820010

9582LI

insegna luminosa bifacciale da interni



9582LI

1 095820050

9577Mtuta in T/C twill di poliestere/cotone 65/35,
240 g

Misure

S	1	095770051
M	1	095770052
L	1	095770053
XL	1	095770054
XXL	1	095770055
XXXL	1	095770056

9579C

camice in poliestere/cotone



Misure

M	1	095791002
L	1	095791003
XL	1	095791004

9575copertina a ventosa, in tessuto plastificato
con quattro ventose sul lato superiore

9575

1 095750001

9563P

poltrona da ufficio con braccioli, colore nero



9563P

1 095630010

9549PB

batteria portatile, ultrasottile, 5400mA



9549PB

1 095490051

9549USB

chiavetta usb, 8 GB



9549USB

1 095490061

9547

calcolatrice da tavolo



9547

1 095470000

9594

orologio da parete dotato di termometro
ed igrometro, diametro 26 cm



Ø
cm
26   1 095940051

9527 6T

set 6 tazzine caffè



9527 6T   1 095270001

9527MUG

tazza "mug" con coperchio e fascia in silicone



9527MUG   1 095270020

9581

accendino, carica a benzina





9581   1 095811001

9586K

coltellino multiuso in acciaio,
10 funzioni



9586K   1 095860100

9592B/C50

set 50 penne



9592B/C50   1 095920050

9592B/P

penne personalizzate



9592B/P   500 095920051

9588M

termoformato morbido con 1 penna e 2 block
notes





9588M   1 095880011



9596

portabadge in poliester con moschettone
in metallo e filo portatelefono





9596   10 095961001

9595C

portachiave in pelle



9595C   1 095950011

9595T

portachiave in metallo cromato, in bustina di
velluto



9595T   1 095950021

9595 C25

portachiave in metallo cromato con gancio in
gomma



9595 C25   1 095950031

9569P

shopper in polietilene,
con soffietti laterali



9569 44x34

50 095691001

9569S

shopper in TNT con soffietto, 38x42 cm



9569S

50 095690051

9587 9x14

set 5 taccuini, 9x14 cm



9587 9x14

1 095870009

9587 13x21

set 5 taccuini, 13x21 cm



9587 13x21

1 095870013

9588S/10...

set di 10 block notes



9588S/10A 21x29 cm	1 095881001
9588S/10B 15x21 cm	1 095881002
9588S/10C 10x15 cm	1 095881003
9588S/10D 7,5x10,5 cm	1 095880054

9588/10PI

set di 10 blocchetti per appunti
con fogli adesivi



9588/10PI
7,5x7,5 cm

1 095880055

9589A/36

confezione da 36 rotoli di nastro adesivo
per imballo, logo Beta, avana



9589A/36

1 095890035

9589B/36

confezione da 36 rotoli di nastro adesivo
per imballo, logo Beta, bianco



9589B/36

1 095890036



SERVIZIO DI TARATURA DINAMOMETRIA

Beta Utensili SpA dispone di attrezzature certificate **Accredia (SIT)** per la taratura di chiavi dinamometriche fino a **3000 Nm**, in conformità alla **norma UNI EN ISO 6789**.

Presso il **Laboratorio Beta** è possibile eseguire la calibrazione dei seguenti articoli:



Chiavi a slittamento, a disinnesto o scatto



Chiavi non graduate



Giravite dinamometrici



Chiavi a lettura



Chiavi digitali



Dynatester

Le calibrazioni sono eseguite in senso destrorso. Per le chiavi dinamometriche digitali e i giravite dinamometrici è possibile richiedere la certificazione destrorsa, sinistrorsa o entrambe.

La norma prevede un controllo su tre punti (20%, 60% e 100% della capacità massima della chiave) con cinque campionamenti.

Per le chiavi pretarate è previsto un solo punto di controllo (richiesto dal cliente) con cinque campionamenti. I Dynatester vengono certificati presso un laboratorio esterno accreditato UKAS, riconosciuto a livello internazionale. Per la calibrazione sono previsti 3 campionamenti su più punti, in un senso di rotazione o in entrambi.

Il certificato di calibrazione viene rilasciato direttamente dal Laboratorio Beta.

Il certificato di taratura viene rilasciato da un laboratorio esterno, Accredia (SIT).

La validità dei certificati è pari a 5.000 cicli o a un anno dal primo utilizzo, secondo quanto previsto dalla norma UNI EN ISO 6789.

VALORE SELEZIONATO		TOLLERANZA		VALORI RISPUNTI				
Set Torque	200	5%	10%	Actual Results				
1200	11.51	11.96		11.52	11.21	11.19	11.19	11.19
1600	15.62	15.80		15.21	15.23	15.11	15.16	15.17
1800	17.45	17.56		17.17	17.16	17.00	17.12	17.16

LA TOLLERANZA SELEZIONATA È IL VALORE RISPUNTO PER IL CONTROLLO
The tolerance chosen and the test represented for the calibration.
CONFORME ALLA NORMA
Compliant with the requirements of: **ISO 6789 / 2001**
CONFORME ALLA STRUMENTI DI PROVA, R 2010 (1) (1) (1) (1) (1)
The accuracy of the test equipment at 20°C is ± 1% k=2

L'ATTREZZATURA È STATO USATO NEL CONFORMITÀ A NORME E CARATTERISTICHE DA TRACCIARE INTERNAZIONALI
The test equipment used is in compliance with the international standards.
INTELLIGIBILE
Torque wrench
SERIE: M2
Set No: 7500
CERT. ACCREDITA NO:
ACCREDITA (SIT) NO: 47-154-0231-2012
LABORATORIO:
Laboratory No: 401

DATA DEL CERTIFICATO:
Date of calibration:
18/06/12
RESPONSABILE QUALITÀ:
Quality Manager:
F. Caviglia

Per usufruire di questo servizio rivolgetevi al tuo rivenditore di fiducia

CAMPI DI IMPIEGO CHIAVI E BARRE DINAMOMETRICHE

1Nm=0,10197 Kgfm=0,7375lbf.ft



Dimensione	Modello	Capacità	Scala	Scala	Scala	Scala	Scala	Scala	Scala	Scala	Scala	Scala	Scala	Scala	Scala	Scala	Scala	Scala	Scala
1/4"	590		0,3	4															
	590/1		0,5	13,5															
	603/5		1	5															
	603/10		2	10															
	605E/5		1	5															
	605E/10		2	10															
3/8"	606/2			4	20														
	592/3		1	27															
	592/4		3	40															
	599DGT/6			12	60														
	606/2X			4	20														
	606/6			8	60														
	606/10			20	100														
	666N/5			10	50														
	666N/10			20	100														
	666N LBF.IN/5			90 LBF.IN	440 LBF.IN														
1/2"	666N LBF.IN/10			200 LBF.IN	800 LBF.IN														
	594/8			6	80														
	594/21			20	215														
	599DGT/10X			20	100														
	599DGT/20			40	200														
	599DGT/30			68	340														
	599DGT/A10			20	100														
	599DGT/A20			40	200														
	606/10X			20	100														
	606/20			40	200														
	606/30			60	330														
	606MQ/50			5	50														
	666N/10X			20	100														
	666N/20			40	200														
	666N/30			60	300														
	666N LBF.IN/10X			200 LBF.IN	800 LBF.IN														
	666N LBF.IN/20			400 LBF.IN	1800 LBF.IN														
	666N LBF.IN/30			500 LBF.IN	3000 LBF.IN														
	667N/20			40	200														
	667N/30			60	300														
3/4"	596/40SL			80	400														
	596/80SL			40	800														
	667N/40			80	400														
	677/50 677C/50			100	500														
	677/70 677C/70			150	700														
	677/100 677C/100			300	1000														
	677C/150			700	1500														
	678C/55			110	550														
	678C/100			300	1000														
	678C/150			500	1500														
1"	598/200SL			200	2000														
	677/CP200			900	2000														

Dimensione	Modello	Capacità	Scala	Scala	Scala	Scala	Scala	Scala	Scala	Scala	Scala	Scala	Scala	Scala	Scala	Scala	Scala	Scala	Scala
Ø 8 mm	604B/5		1	5															
	604B/10		2	10															
	608/2			4	20														
Ø 16 mm	668N/5			10	50														
	668N/10			20	100														
	668N/20			40	200														
	668N/30			60	300														
	668RG/6			8	60														
	668RG/10			20	100														
	668RG/20			40	200														
	668RG/30			60	300														
	9x12 mm	669N/5			10	50													
669N/10				20	100														
669N/20				40	200														
14x18 mm	669N/20X			40	200														
	669N/30			60	300														



ARTICOLI ELIMINATI – ARTICOLI SOSTITUTIVI/CONSIGLIATI

ARTICOLO ELIMINATO			
ARTICOLO SOSTITUTIVO			
ARTICOLO CONSIGLIATO			
42 /B6	000420049	42 /B9	000420064
42 /SP17	000420075	42 /S17	000420065
42 /SPV1	000420080		
55 /B6	000550150	55 /B8	000550158
195FTX E6XE8	001950406	95 FTX6X8	000950306
195FTX E10XE12	001950410	95 FTX10X12	000950310
195FTX E14XE18	001950414	95 FTX14X18	000950314
195FTX E20XE24	001950420	95 FTX20X24	000950320
195 FTX/B4	001950501	95 FTX/S4	000950325
720 IP17	007200667		
720 IP19	007200669		
720 IP21	007200671		
720 LPL17	007200717	720 LC17	007200637
720 LPL19	007200719	720 LC19	007200639
720 LPL21	007200721	720 LC21	007200641
720 LPL/C3	007200750		
720 T/90	007200760	720 TC/90	007200769
720 T/100	007200762	720 TC/100	007200770
720 T/110	007200764	720 TC/110	007200771
720 T/120	007200766	720 TC/120	007200772
720 T/B4	007200780	720 TC/S5	007200779
728 LS/S3	007280550		
855 T	008550050	855 P	008550010
900 LPH/SB7	009000707		
910 LH/SB7	009100479		
920 PE/LS4	009200442		
920 TX/L SB4	009200542	920 TX/L SB10	009200545
920 TX/L SB6	009200543	920 TX/L SB10	009200545
930 /S12	009300082	930 /S13	009300083
930 /SP13	009300084	930 /S13	009300083
930 /SPV	009300095		
935 /S12	009350182	935 /S13	009350183
960 KI	009600235	1462 /KI	014620235
960 TP	009600300	1464 T	014640050
960 TAP	009600350	1464 AP	014640450
1153 160	011530016	1153 200	011530120
1153 200	011530020	1153 200	011530120
1263 /D5	012630005	1263 /D6	012630006
1461 /C3B	014610031	1461 /C3B	014610032
1461 /C5G	014610052	1461 /C5G	014610053
1461 /C6B	014610061	1461 /C6B	014610063
1461 /C6G	014610062	1461 /C6G	014610064
1461 /C7B	014610071	1461 /C7B	014610072
1461 /C8B	014610081	1461 /C8B	014610083
1461 /C8G	014610082	1461 /C8G	014610084
1461 /C9B	014610091	1461 /C9B	014610092
1461 /C10G	014610102	1461 /C10G	014610103
1461 /C11G	014610112	1461 /C11G	014610113
1461 /C12A	014610121	1461 /C12A	014610123
1461 /C12G	014610122	1461 /C12G	014610124
1461 /C13A	014610131	1461 /C13A	014610133
1461 /C13B	014610132	1461 /C13B	014610134
1461 /C18B	014610181	1461 /C18B	014610182
1461 /C20G	014610200	1461 /C20G	014610221
1461 /C21G	014610201	1461 /C21G	014610222
1461 /C22B	014610202	1461 /C22B	014610223
1461 /C23B	014610203	1461 /C23B	014610224
1461 /C24B	014610204	1461 /C24B	014610225
1461 /C25G	014610205	1461 /C25G	014610226
1461 /C26B	014610206	1461 /C26B	014610227
1461 /C27G	014610207	1461 /C27G	014610228
1461 /C28B	014610208	1461 /C28B	014610229
1461 /C30G	014610210	1461 /C30G	014610231
1505	015050010	1505 V	015050001
1550 /2	015500002	1550 U	015500010
1550 /2-SR90	015500150		
1550 /2-SR150	015500151		
1550 /2-SR175	015500152		
1550 /2-SR205	015500153		
1550 /2-PS	015500157		

1550 /2-MRC	015500161		
1566 /GO	015660051	1566 /GO1	015660052
1688 BC	016880200	1688 PC	016880300
1688 BC/R	016880210		
1691 BG/3	016910103	1692 /3	016920053
1691 BG/5	016910105	1691 BM/5	016910205
1691 BG/8	016910108	1691 BM/8	016910208
1691 BG/10	016910110	1691 BM/10	016910210
1761	017610001	1761	017610101
1761 RS/1	017610030	1761 RS/1	017610130
1836	018360100	1836 A	018360050
1837 E	018370501	1837 +	018370026
1842 XBM	018420201	1842 LED/BM	018420301
1842 XABM	018420211	1842 LED/ABM	018420311
1846 XBM	018460201	1846 LED/BM	018460301
1846 XABM	018460211	1846 LED/ABM	018460311
	018460231	1846 R-LED/BM	018460331
1860 E/120A	018600120	1860 K/160A	018600160
1860 E/150A	018600150	1860 K/160A	018600160
1927 DA	019270033	1927 XM	019270030
2029 BG-MQ	020290255	2029 BG-MQ	020290256
2032 ET/A	020320117	2032 ET/A	020320118
2032T ET/A	020320227	2032T ET/A	020320228
2107 VU/3	021070103	2107 VU/3	021070104
2109 VU/3	021090123	2109 VU/3	021090124
2110 VU/3	021100023	2110 VU/3	021100024
2110 VU/AS	021100025	2110 VU/AS	021100026
2110S VU/3	021100103	2110S VU/3	021100104
2111 VU/3	021110103	2111 VU/3	021110104
2112 ET/A	021120127	2112 ET/A	021120128
2112 VU/5	021120155	2112 VU/5	021120156
2115P L-VU/3	021150243	2115P L-VU/3	021150244
2116 VU/3	021160103	2116 VU/3	021160104
2117 P-VU/3	021170043	2117 P-VU/3	021170044
2117 PL-VU/3	021170143	2117 PL-VU/3	021170144
2119 VU/3	021190023	2119 VU/3	021190024
2119 L-VU/3	021190123	2119 L-VU/3	021190124
2120 VU/3	021200017	2120 VU/3	021200028
2120 VU/AS	021200019	2120 VU/AS	021200021
2120 L-VU/3	021200117	2120 L-VU/3	021200128
2120 L-VU/AS	021200119	2120 L-VU/AS	021200121
2200 S-O/VI	022000425	2200 S-O/VI	022000461
2200 S-G/VI	022000426	2200 S-G/VI	022000462
2200 S-R/VI	022000427	2200 S-R/VI	022000463
2400 SL-O/VI2T	024002407	2400 SL-O/VI2T	024002431
2400 SL-G/VI2T	024002408	2400 SL-G/VI2T	024002432
2400 SL-R/VI2T	024002409	2400 SL-R/VI2T	024002433
2400SAXL7-O/VI3T	024002451	2400SAXL7-O/VI3T	024002464
2400SAXL7-G/VI3T	024002452	2400SAXL7-G/VI3T	024002465
2400SAXL7-R/VI3T	024002453	2400SAXL7-R/VI3T	024002466
2400 S7-O/VI2T	024002761	2400 S7-O/VI2T	024002434
2400 S7-G/VI2T	024002762	2400 S7-G/VI2T	024002435
2400 S7-R/VI2T	024002763	2400 S7-R/VI2T	024002436
2400 S8-O/VI3T	024002817	2400 S8-O/VI3T	024002861
2400 S8-G/VI3T	024002818	2400 S8-G/VI3T	024002862
2400 S8-R/VI3T	024002819	2400 S8-R/VI3T	024002863
2424 T296	024240296	2424 T297	024240297
2499 PP/IM	024990060	1927 SP-AM	019270000
2500 /VI	025000077	2500 /VI	025000087
3000 /VI3	030000098	3000 /VI3	030000099
3063 /2,5T	030630025	3063 /2,5T	030630125
4100S /SBK	041000104		
4100S VU/5	041000105		
4100H /SBK	041000114		
4100H VU/5	041000115		
4200S /SBK	042000084		
4200S VU/5	042000085		
4200H /SBK	042000094		
4200H VU/5	042000095		
CP52-O	052000501	CP51-O	051000501
CP52-G	052000502	CP51-G	051000502
CP52-R	052000503	CP51-R	051000503
C57 P	057000020	C57S P/O	057001020
5700 PO/U	057000195	5700 PO/U	057001075

C57 P/G	057000220	C57S P/G	057001220
5700 PG/U	057000395	5700 PG/U	057001275
C57 P/R	057000420	C57S P/R	057001420
5700 PR/U	057000595	5700 PR/U	057001475
C57S A/O	057001001	C57S A/O	057001005
C57S B/O	057001002	C57S B/O	057001006
5700 AO/VI	057001096	5700 AO/VI	057001091
5700 AO/VG	057001097	5700 AO/VG	057001092
5700 BO/VI	057001098	5700 BO/VI	057001093
5700 BO/VG	057001099	5700 BO/VG	057001094
C57S A/G	057001201	C57S A/G	057001205
C57S B/G	057001202	C57S B/G	057001206
5700 AG/VI	057001296	5700 AG/VI	057001291
5700 AG/VG	057001297	5700 AG/VG	057001292
5700 BG/VI	057001298	5700 BG/VI	057001293
5700 BG/VG	057001299	5700 BG/VG	057001294
C57S A/R	057001401	C57S A/R	057001405
C57S B/R	057001402	C57S B/R	057001406
5700 AR/VI	057001496	5700 AR/VI	057001491
5700 AR/VG	057001497	5700 AR/VG	057001492
5700 BR/VI	057001498	5700 BR/VI	057001493
5700 BR/VG	057001499	5700 BR/VG	057001494
C58 P/B	058000021	C58 P/O	058000121
5800 P/BU	058000197	5800 P-O	058000181
5902 VI	059020040	5902 VI	059020050
5904 VI/2T	059040163	5904 VI/2T	059040164
5904 VI/3T	059040167	5904 VI/3T	059040168
5910 VI/3	059100052	5910 VI/3	059100053
5915 VU3	059150126	5915 VU3	059150128
5915 VUAS	059150131	5915 VUAS	059150132
5915 VU5	059150155	5915 VU5	059150156
5940 SBK	059400071	5940 SBK	059400081
5980 MQ	059800255	5980 MQ	059800256
5980 ET/A	059800261	5980 ET/A	059800262
7208RK 39	072080139	7243CR 39	072430739
7208RK 40	072080140	7243CR 40	072430740
7208RK 41	072080141	7243CR 41	072430741
7208RK 42	072080142	7243CR 42	072430742
7208RK 43	072080143	7243CR 43	072430743
7208RK 44	072080144	7243CR 44	072430744
7208RK 45	072080145	7243CR 45	072430745
7208RK 46	072080146	7243CR 46	072430746
7208RK 47	072080147	7243CR 47	072430747
7254NA 38	072540138	7235B 38	072350238
7254NA 39	072540139	7235B 39	072350239
7254NA 40	072540140	7235B 40	072350240
7254NA 41	072540141	7235B 41	072350241
7254NA 42	072540142	7235B 42	072350242
7254NA 43	072540143	7235B 43	072350243
7254NA44	072540144	7235B44	072350244
7254NA45	072540145	7235B 45	072350245
7254NA46	072540146	7235B 46	072350246
7254NA47	072540147	7235B 47	072350247
7255NA38	072550138	7236B 38	072360238
7255NA39	072550139	7236B 39	072360239
7255NA40	072550140	7236B 40	072360240
7255NA41	072550141	7236B 41	072360241
7255NA42	072550142	7236B 42	072360242
7255NA43	072550143	7236B 43	072360243
7255NA44	072550144	7236B 44	072360244
7255NA45	072550145	7236B 45	072360245
7255NA46	072550146	7236B 46	072360246
7255NA47	072550147	7236B 47	072360247
7293TKK38	072930238	7294TKK 38	072940238
7293TKK39	072930239	7294TKK 39	072940239
7293TKK40	072930240	7294TKK 40	072940240
7293TKK41	072930241	7294TKK 41	072940241
7293TKK42	072930242	7294TKK 42	072940242
7293TKK43	072930243	7294TKK 43	072940243
7293TKK44	072930244	7294TKK 44	072940244
7293TKK45	072930245	7294TKK 45	072940245
7293TKK46	072930246	7294TKK 46	072940246
7293TKK47	072930247</		

ARTICOLI ELIMINATI – ARTICOLI SOSTITUTIVI/CONSIGLIATI

ARTICOLO ELIMINATO
ARTICOLO SOSTITUTIVO
ARTICOLO CONSIGLIATO

7329B 38	073290538		
7329B 39	073290539		
7329B 40	073290540		
7329B 41	073290541		
7329B 42	073290542		
7329B 43	073290543		
7329B 44	073290544		
7329B 45	073290545		
7329B 46	073290546		
7329B 47	073290547		
7330B 38	073300538		
7330B 39	073300539		
7330B 40	073300540		
7330B 41	073300541		
7330B 42	073300542		
7330B 43	073300543		
7330B 44	073300544		
7330B 45	073300545		
7330B 46	073300546		
7330B 47	073300547		
7347RP 38	073470138		
7347RP 39	073470139		
7347RP 40	073470140		
7347RP 41	073470141		
7347RP 42	073470142		
7347RP 43	073470143		
7347RP 44	073470144		
7347RP 45	073470145		
7347RP 46	073470146		
7347RP 47	073470147		
7348RP 38	073480138		
7348RP 39	073480139		
7348RP 40	073480140		
7348RP 41	073480141		
7348RP 42	073480142		
7348RP 43	073480143		
7348RP 44	073480144		
7348RP 45	073480145		
7348RP 46	073480146		
7348RP 47	073480147		
7360BKK 38	073600238	7361UM 38	073610338
7360BKK 39	073600239	7361UM 39	073610339
7360BKK 40	073600240	7361UM 40	073610340
7360BKK 41	073600241	7361UM 41	073610341
7360BKK 42	073600242	7361UM 42	073610342
7360BKK 43	073600243	7361UM 43	073610343
7360BKK 44	073600244	7361UM 44	073610344
7360BKK 45	073600245	7361UM 45	073610345
7360BKK 46	073600246	7361UM 46	073610346
7360BKK 47	073600247	7361UM 47	073610347
7361DKK 38	073610038	7361UB 38	073610238
7361DKK 39	073610039	7361UB 39	073610239
7361DKK 40	073610040	7361UB 40	073610240
7361DKK 41	073610041	7361UB 41	073610241
7361DKK 42	073610042	7361UB 42	073610242
7361DKK 43	073610043	7361UB 43	073610243
7361DKK 44	073610044	7361UB 44	073610244
7361DKK 45	073610045	7361UB 45	073610245
7361DKK 46	073610046	7361UB 46	073610246
7361DKK 47	073610047	7361UB 47	073610247
7361GKK 38	073610138		
7361GKK 39	073610139		
7361GKK 40	073610140		
7361GKK 41	073610141		
7361GKK 42	073610142		
7361GKK 43	073610143		
7361GKK 44	073610144		
7361GKK 45	073610145		

7361GKK 46	073610146		
7361GKK 47	073610147		
7368NKK 38	073680038	7368UN 38	073680338
7368NKK 39	073680039	7368UN 39	073680339
7368NKK 40	073680040	7368UN 40	073680340
7368NKK 41	073680041	7368UN 41	073680341
7368NKK 42	073680042	7368UN 42	073680342
7368NKK 43	073680043	7368UN 43	073680343
7368NKK 44	073680044	7368UN 44	073680344
7368NKK 45	073680045	7368UN 45	073680345
7368NKK 46	073680046	7368UN 46	073680346
7368NKK 47	073680047	7368UN 47	073680347
7368BKK 38	073680138	7368UM 38	073680538
7368BKK 39	073680139	7368UM 39	073680539
7368BKK 40	073680140	7368UM 40	073680540
7368BKK 41	073680141	7368UM 41	073680541
7368BKK 42	073680142	7368UM 42	073680542
7368BKK 43	073680143	7368UM 43	073680543
7368BKK 44	073680144	7368UM 44	073680544
7368BKK 45	073680145	7368UM 45	073680545
7368BKK 46	073680146	7368UM 46	073680546
7368BKK 47	073680147	7368UM 47	073680547
7368GKK 38	073680238	7368UG 38	073680438
7368GKK 39	073680239	7368UG 39	073680439
7368GKK 40	073680240	7368UG 40	073680440
7368GKK 41	073680241	7368UG 41	073680441
7368GKK 42	073680242	7368UG 42	073680442
7368GKK 43	073680243	7368UG 43	073680443
7368GKK 44	073680244	7368UG 44	073680444
7368GKK 45	073680245	7368UG 45	073680445
7368GKK 46	073680246	7368UG 46	073680446
7368GKK 47	073680247	7368UG 47	073680447
7369GKK 38	073690138	7369UB 38	073690238
7369GKK 39	073690139	7369UB 39	073690239
7369GKK 40	073690140	7369UB 40	073690240
7369GKK 41	073690141	7369UB 41	073690241
7369GKK 42	073690142	7369UB 42	073690242
7369GKK 43	073690143	7369UB 43	073690243
7369GKK 44	073690144	7369UB 44	073690244
7369GKK 45	073690145	7369UB 45	073690245
7369GKK 46	073690146	7369UB 46	073690246
7369GKK 47	073690147	7369UB 47	073690247
7399 M-90	073990013		
7399 M-120	073990014		
7817N /XS	078170000		
7817N /S	078170001		
7817N /M	078170002		
7817N /L	078170003		
7817N /XL	078170004		
7817N /XXL	078170005		
7817N /XXXL	078170006		
7827 /XS	078270000		
7827 /S	078270001		
7827 /M	078270002		
7827 /L	078270003		
7827 /XL	078270004		
7827 /XXL	078270005		
7827 /XXXL	078270006		
7827 /XXXXL	078270007		
7937P /XS	079370100		
7937P /S	079370101		
7937P /M	079370102		
7937P /L	079370103		
7937P /XL	079370104		
7937P /XXL	079370105		
7937P /XXXL	079370106		
7980 BLACK/M	079800002		
7980 BLACK/L	079800003		
7980 BLACK/XL	079800004		
7982 G	079820009		
7982 B	079820109		
7995 /S	079950001		
7995 /M-L	079950002		

7995 /XL-XXL	079950004		
8020 28	080200028		
8057 2	080570020	8057R 2	080570120
8057 3,15	080570032	8057R 3,15	080570132
8058 2	080580020	8058R 2,0	080580120
8058 3,15	080580032	8058R 3,15	080580132
8060 5,3	080600053	8060R 5,3	080600153
8061 F1,12	080610111	8061R 1,12	080610211
8061 F2	080610120	8061R 2,0	080610220
8061 F3,15	080610131	8061R 3,15	080610231
8188 F35-MT4	081880290	8188V F35-MT4	081881290
8188 FG2-MT3	081880530	8188V FG2-MT3	081881530
TV	088880001		
TOV	088880002		
9521 O/OB	095210011	9521 W	095210111
9525 /ITA	095250050	9525 C	095250051
9525 BS/N	095251011	9525 R	095250071
9528	095280000		
9536 S	095361011		
9536 M	095361012		
9536 L	095361013		
9536 XL	095361014		
9536 XXL	095361015		
9539 C	095391000	9539 C/M	095390000
9540 M/XS	095400041		
9540 M/S	095400042		
9540 M/M	095400043		
9540 M/L	095400044		
9540 M/XL	095400045		
9540 M/XXL	095400046		
9540 M/XXXL	095400047		
9540 P/XS	095400051		
9540 P/S	095400052		
9540 P/M	095400053		
9540 P/L	095400054		
9540 P/XL	095400055		
9540 P/XXL	095400056		
9540 P/XXXL	095400057		
9546	095460100		
9557 J	095570011	9557 J2.0	095570020
9572 GG/XS	095720000		
9572 GG/S	095720001		
9572 GG/M	095720002		
9572 GG/L	095720003		
9572 GG/XL	095720004		
9572 GG/XXL	095720005		
9572 GB/XS	095720100		
9572 GB/S	095720101		
9572 GB/M	095720102		
9572 GB/L	095720103		
9572 GB/XL	095720104		
9572 GB/XXL	095720105		
9572 GC/XS	095720200		
9572 GC/S	095720201		
9572 GC/M	095720202		
9572 GC/L	095720203		
9572 GC/XL	095720204		
9572 GC/XXL	095720205		
9572 H/S	095720501		
9572 H/M	095720502		
9572 H/L	095720503		
9572 H/XL	095720504		
9572 H/XXL	095720505		
9577 F1-S	095771001	9577 M-S	095770051
9577 F1-M	095771002	9577 M-M	095770052
9577 F1-L	095771003	9577 M-L	095770053
9577 F1-XL	095771004	9577 M-XL	095770054
9577 F1-XXL	095771005	9577 M-XXL	095770055
9577 F1-XXXL	095771006	9577 M-XXXL	095770056
9592 G	095900001	9592 B	095900000
9592 S/50P	095920201	9592 B/C50	095920050
9592 P/P	095920701	9592 B/P	095920051
9595 M/10	095950070		

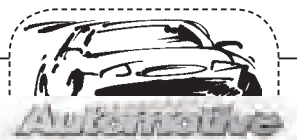

Abbigliamento da lavoro	406÷419
Accessori per funi Robur	420÷450
Accessori portautensili per armadietti, cassetti e pareti	357÷359
Armadi per officina	289-290
Armadietti portautensili	269-270
Arredamento Officina	278÷292
Artigli prensili flessibili	170
Ascia antiscintilla	214
Aspiratore per liquidi	193
Aspiratori per solidi e liquidi	192
Assortimenti di utensili	293÷339
Assortimenti utensili in termoformato	293÷357
Attrezzi per il ripristino delle filettature	42-43
Avvolgicavo automatici con portalampada	189-190
Avvolgitubo automatici per aria/acqua	227
Banchi da lavoro	271÷280
Barre dinamometriche	53÷56
Bauli portautensili	236
Beta Collection	451÷460
Bordatubi	32
Borse portautensili	231÷235
Bulini	15
Cacciaspina	15, 209
Calibri a corsoio	163-164
Calzature di sicurezza	383÷405
Carrelli portautensili	251÷253, 268
Carrello porta cassettiere	239
Cassettiere mobili	239÷264, 281
Cassettiere portatili	237-238, 257
Cesoie	109
Cesoie a cricchetto per tubi PVC	31
Cestelli portautensili	234÷236
Chiavi a bussola con impugnatura	92, 202
Chiavi a bussola Macchina, accessori e assortimenti	58÷63
Chiavi a bussola snodate doppie	20
Chiavi a bussola, accessori e assortimenti 1/4"	70÷74
Chiavi a bussola, accessori e assortimenti 3/8"	75÷79
Chiavi a bussola, accessori e assortimenti 1/2"	79÷88, 202, 211
Chiavi a bussola, accessori e assortimenti 3/4"	88÷89, 211
Chiavi a bussola, accessori e assortimenti 1"	89-90
Chiavi a cricchetto	27÷29, 142
Chiavi a forchetta	17÷19, 202, 209
Chiavi a percussione	19, 209-210
Chiavi a pipa	91-92, 212
Chiavi a settore	26-27, 210
Chiavi a T con bussola esagonale e Torx®	93÷95
Chiavi a T maschio esagonale e Torx®	93÷95, 203
Chiavi a tubo	90-91, 95
Chiavi a zampa di gallo	77
Chiavi combinate	16-17, 28, 205, 209
Chiavi di manovra antiscintilla per valvole	212
Chiavi e barre dinamometriche	51÷57
Chiavi maschio esagonale e Torx® con impugnatura	24÷26, 206
Chiavi maschio esagonale e Torx®, piegate	21÷26, 206, 210



Chiavi maschio piegate a profilo XZN®	26
Chiavi per ponteggi	21, 210
Chiavi per raccordi	21, 27-28
Chiavi poligonali	19÷21, 27÷29, 202, 211
Chiavi regolabili a rullino	27, 202, 210
Coltelli	184-185, 204, 214
Comparatori	164-165
Compassi	166
Compressori a leva per grasso	177-178
Contafiletti	170
Contalitri per olio	194
Cuffie antirumore	418
Curvatubi	35
Cuscino sollevatore	185
Cutter	183-184
Estrattori per viti e prigionieri danneggiati	131-132
Estrattori a due griffe	151÷153, 158
Estrattori a tre griffe	153, 158
Estrattori coni Morse	40
Estrattori idraulici	158
Estrattori per mozzi ruote	154
Estrattori vari	151÷158
Fascette	177
Filiere e assortimenti	44÷47
Flessibili magnetici	170
Flessometri e metri	167-168
Forbici	109-110, 185, 203, 214
Forbici per elettricisti	110, 203
Frese coniche	39-40
Fustelle	108-109
Gamma blister	360÷369
Giramaschi e girafiliera	42, 45
Giratubi	33-34, 211
Giravite a battere	117
Giravite a percussione	124
Giravite a squadra	117
Giravite BetaEasy	115-116
Giravite BetaGrip	119÷122, 204
Giravite BetamaX	122÷125, 206, 213
Giravite bivalenti	121-122
Giravite cercafase	117
Giravite dinamometrici	50-51
Giravite prensili	117
Goniometri per serraggi angolari	52
Goniometri semplici	166
Guanti isolanti	204
Idraulica, vari	29÷35
Inserti per avvitatori e portainseriti	27, 63÷70, 117-118, 202
Lampade	186÷190, 273, 288
Leve	99, 169, 212
Lime	40, 126, 171÷174, 214
Livelle e stadie	168-169
Magnetizzatore-smagnetizzatore	115
Martelli	127÷129, 213
Martinetto idraulico	158



Maschera per saldatura	191
Mascherina antipolvere	418
Maschi e assortimenti	40÷43,45÷47
Matita per falegnami	167
Mazze	130, 213
Mazzette	129-130, 213
Mazzuole	130-131, 214
Microgiravite	117÷119
Micrometri	164
Misuratori di coppia elettronici Dynatester	51, 57-58
Moltiplicatori di coppia	49-50
Morse parallele da banco	159
Morse ribaltabili da banco, per idraulica	35
Morsetti	159
Multimetri	180-181
Nastro isolante	163
Occhiali di protezione	418
Oliatori	178
Pala antiscintilla	214
Pareti portautensili	273-274, 287÷289
Pennello	175
Piccone antiscintilla	214
Pinza foralamiera	106
Pinza fustellatrice	182
Pinza piegalamiera	106
Pinze a becchi lunghi e lunghissimi	102-103, 112, 203-204, 213
Pinze allargatubi	31-32
Pinze amperometriche	181
Pinze autobloccanti	105-106
Pinze per anelli elastici di sicurezza	103-104, 212
Pinze per capicorda e capicorda	159÷162
Pinze per elettronica	113
Pinze per fascette e fascette	176-177
Pinze regolabili	104-105, 112, 203, 212
Pinze torcifilo	182
Pinze universali	112, 203, 213
Pinzette a molla	101-102
Pistola per olio	194
Pistole per colla	190
Pistole per sigillanti	177
Pistole termiche	190
Polifusori e matrici	29-30
Pompe per barili	194
Pompette per dissaldare	186
Porta attrezzi con cintura	231
Portacarta	249-250
Portaflaconi	249-250
Portaminuterie magnetici	183
Postazione di lavoro mobile	254-255
Provatensione	149, 190
Punte elicoidali cilindriche per forare	35÷38
Punte per forare, filettare e svasare	43
Punte per tracciare	167
Punte speciali per saldature	39
Punteruoli	171



Punzonatrice oleodinamica	163
Punzoni	15, 209
Raggimetri	170
Rapportatore d' angoli	166
Raschietti	142, 171, 184, 214
Righe graduate	166
Ripara plastiche	127
Rivettatrici e rivetti	175-176
Saldatori	185-186
Saldatrici	191
Sbavatori per tubi	32
Scalpelli	15, 209
Scalpelli per carrozzieri	101, 126
Scalpelli per edilizia	169, 214
Segaccio per legno	174
Seghe e frese a tazza e accessori	47-48
Seghetti e lame	174, 214
Segoncino ad arco	174
Serraggiunti e strettoi	159
Siringa per olio	178
Soluzioni per il punto vendita	370÷382
Sonda tirafili	163
Spaccadadi	170
Spazzole	174-175, 214
Specchietti	170-171
Spellacavi e spellafili	111
Spessimetri	170
Squadre	165-166
Supporto per avvitatore pneumatico	217
Tachimetro digitale	181
Tagliacavi	110-111
Tagliacavi per cavi in acciaio	111
Tagliafuni di acciaio	108
Tagliatubi	30-31, 211
Tappeto isolante	204
Tenaglie	107-108
Tenditore per molle	174
Termoformati portautensili	340÷357
Termometri	182
Termopiastre per tubi plastici	29
Torce	186-187
Traccialinea e polvere	169-170
Trolley portautensili	231÷234, 265-266
Troncabulloni	108
Tronchesi a taglienti diagonali e frontali	107, 114, 203, 212
Tronchesi per elettronica	114
Ugnetti	16
Utensili antiscintilla	208÷214
Utensili in acciaio inossidabile	205÷207
Utensili isolati 1000V	201÷204
Utensili pneumatici ed accessori	215÷229
Valigie portautensili	231÷233
Ventose	182
Videoscopio elettronico	98
Zaino portautensili	233

INDICE ALFABETICO UTENSILI PER AUTORIPARAZIONE



Alesatori per sedi iniettori	97
Aspiratore di vapori iniettori Diesel	98
Attrezzi per centraggio frizioni	132
Attrezzi per estrazione autoradio	182
Attrezzi per pistoni	132
Attrezzi per pulegge distribuzione	137, 142, 145-146, 154
Attrezzi per rimozione cristalli	182-183
Attrezzi per sostituzione piattelli valvole	138
Attrezzi per tubi scarico	141
Attrezzo per pistoncini freni a disco	139
Attrezzo per smagliatura catene	157-158
Avviatori	149-150
Barre di torsione per dadi ruote	63
Calibri a corsoio per dischi e tamburi freni	163
Calibro per battistrada pneumatici	170
Caricabatteria	150
Carrello per movimentazione veicoli	195
Carrello sottoscocca	195
Cavalletti	195
Cavalletti per moto	199
Chiave per braccetti sterzo	157
Chiave per turbine	142
Chiavi a bussola Macchina per dadi assale	99-100
Chiavi a bussola Macchina per dadi ruote	59
Chiavi a bussola Macchina quadre per dadi ruote Isuzu	62
Chiavi a bussola per dadi mozzi ruote	99-100
Chiavi a bussola per dadi mozzi ruote veicoli pesanti	99-100
Chiavi a bussola per iniettori Diesel	95-96
Chiavi a bussola per perni balestre	157
Chiavi a bussola per sonda Lambda	96
Chiavi a croce per dadi ruote	100
Chiavi e bussole per candele d' accensione	95
Chiavi per filtri gasolio	147
Chiavi per filtri olio motore	145÷147
Chiavi per ghiera galleggiante serbatoio	143
Chiavi per tappi scarico olio motore	148
Chiavi per valvole metano	144-145
Densimetro per liquido anticongelante	179
Densimetro per liquido batteria	179
Estrattore per raschiavetri	182
Estrattori per giunti omocineticici	157
Estrattori per pioli	142
Estrattori per snodi sferici	157
Gru idraulica pieghevole	196
Imbuto	179
Inseritori a percussione per cuscinetti conici e paraoli	158
Lamina modellabile in alluminio	179
Lettini sottomacchina	195
Leva per estrazione testine braccio oscillante	157

INDICE ALFABETICO UTENSILI PER AUTORIPARAZIONE



Levagomme	99
Leve per carrozzieri	126
Lime per carrozzieri	126
Martelli per carrozzieri	127
Messa in fase	133-137
Morsetti alzavalvola	133
Perni guida montaggio ruote	101
Pinza per anelli di tenuta valvole	133
Pinza per anelli elastici di sicurezza SP	133
Pinza per equilibratura ruote	101
Pinze per anelli stringitubo	140-141
Pinze per cappucci candele	141
Pinze per freni	139
Pinze per occlusione tubi e manicotti	143
Pinze per raccordi rapidi tubi carburante	144
Pistola per gonfiaggio pneumatici	226
Pompa per taratura e controllo iniettori Diesel	98
Presse idrauliche	197-198
Pressori per molle ammortizzatori	156
Provatensione	149
Rabboccatori per batterie	179
Recuperatori olio esausto	193
Seggiolino con rotelle	194
Smerigliavalvole pneumatico	133
Sollevatore ruote truck	195
Sollevatori idraulici a bottiglia	196
Sollevatori idraulici a ruote	198
Sollevatori idraulici da fossa	197
Sollevatori oleopneumatici	200
Sostegni motore	196
Spatoline in acciaio Inox	126
Spazzola per morsetti batteria	175
Stetoscopio	151
Strumenti estrazione liquido freni	138
Strumenti per controllo impianto raffreddamento	180
Strumento per controllo compressione motori a benzina e Diesel	97
Strumento per sensori di pressione dei pneumatici	100
Tassi per carrozzieri	125-126
Tenditori per molle	131, 174
Tester digitale pressione e compressione	138
Tester per batteria e impianti di ricarica	151
Utensile per rimozione guarnizioni	154
Utensili per airbag	132
Utensili per bobine candele	141
Utensili per connessioni elettriche	149
Utensili per estrazione silent block	158
Utensili per impianti di condizionamento	144
Utensili per impianto aria condizionata	144
Utensili per iniettori Diesel Common Rail	96-98
Utensili per riempimento filtri gasolio	143
Utensili per rimozione candele preriscaldamento	97
Utensili per valvole pneumatici	101
Utensili per veicoli pesanti	99-100, 157
Vasche per recupero liquidi	193

INDICE ALFANUMERICO

30	15	96BPA	24	334R/I	30	410MIX/SEL19	36	446ASG/C23	46
30BA	209	96BPA/SC9	24, 361	336	30	412	36	446ASW/C36	46
31	15	96BPC	23	338	30	412/C150	37	447/C37	47
31BA	209	96BPC/SC9	24, 361	338R	30	412/SP	37	447/C53	47
31BM	15	96C/AS	22, 361	338R/I	30	412/SP91	37	447/C70	47
31L	15	96C-AS/SC9	22	338RP	30	412A	37	450	47
31SE	15	96L	23	339A	31	412L	37	450/C9	48
32	15	96L/SC12	23	339A/R	31	414	37	450/C13	48
32AU	15	96L/SC8	23	341	31	414/C116	38	450/C21	48
32AUR	15	96LBP	24	341B	31	414/SP	37	450AD	47
34	15	96LBP/SC9	24, 361	341B/RL	31	415	38	450AL	47
34BA	209	96LC	23	341B/RM	31	415/C116	38	450PA/1	48
35	15	96LC/SC12	23	341RL	31	415/SP91	38	450PA/2	48
35PM	15	96LC/SC8	23	342	31	416	38	450PR	48
35PMR	15	96N	22	342A	31	416/SP19	38	451	48
36	15	96N/SC12	22	342A/MOL	31	417	38	451GA	48
37	16	96N/SC9	22	342A/RL	31	417/SP	39	451PA	48
37PM	16	96T	24	342MOL	31	419	39	451PR	49
37PMR	16	96T/AS	25	342RL	31	423	39	452	49
38/DS1	371	96T/SPV	359	342P	31	423A	39	452GA	49
38/DS2	371	96TBP	25	342P/RL	31	424	39	560/C2	49
39BA	209	96TK	362	344	31	424/SP	39	560/C4+	49
42	16	97BTX	25	345	31	425	39	560/C6	49
42/SC9I-E	16	97BTX/B	26	345SB	32	425/SP	39	560/C12	49
42AS	17	97BTX/SC8	26, 362	345SB/R	32	426	39	561	49
42BA	209	97RTX	26	345U	32	426/SP	39	562/1 - 562/2	50
42BA/AS	209	97RTX/B	26	349	32	426SB	40	564/3R - 564/4R	50
42K	361	97RTX/SC8	26	349/SMAS	32	426SB/SP	40	565/1R - 565/2R - 565/3R	50
42LMP	17	97TTX	26	349/SMM	32	426MD	40	565/4R	50
42MP	17	97TX	25	350	32	426MD/SP10	40	565/5R	50
45	17	97TX/BG8	25	351C	32	427	40	567/4R	50
52	17	97TX/SC8	25	351P	32	428/C14	40	567/5R	50
52MQ	202	98XZN	26	352C/U	32	428FC	40	581	50
53	18	99	26	352U	32	428FP	40	583	51
55	18	99BA	210	353N	32	429/C14	41	583/C31	51
55AS	18	99SQ	26	353NM	32	429FC	41	588	51
55BA	209	99ST	27	353N/C6	33	429FP	40	590 - 592	51
55BA/AS	209	99 VNI...	27	355	33	430	41	594	51
55K	361	100	27	357 F3	33	430/SP	41	596 - 598	51
55MP	19	100/KIT	27	357 R/F3	33	430ASC	41	599DGT	52
58	19	110BA	210	358	33	430ASW	41	599DGT-A	52
58BA	209	110MQ	202	358RL	33	431	41	600/1 - 600/2	52
73	19	111	27	359	33	431/SP	41	601C	52
78	19	111G	27	359CH	33	433	41	601CA	52
78AS	19	111K	362	360	33	433ASF	42	603	52
78BA	209	111N	27	360R/...	33	433ASG	42	604B	53
78BA/AS	210	120	27	362	33	434	42	605E	53
80	20	123E1/4	27	362R/...	33	435	42	606/2 - 606/2X	53
83	20	123Q1/4	27	363	33	435G	42	606/6 ÷ 606/30	53
83AS	20	123Q3/8	27	363R/...	33	436	42	606MQ/50	202
89BA	210	123Q1/2	27	363BA	211	436L	42	608/2	53
89MQ	202	123/K4	27, 362	365	34	436R	42	611	53
90	20	142	28	365R/...	34	437C	42	612 ÷ 614	53
90AS	20	142/SC9I-E	28	366	34	437C/...	43	614/50	53
90BA	210	142AS	28	374	34	437C/RM14	43	615	54
90K	361	142C	28	374K	362	437K/8	43	616 - 617 - 619	54
91	21	142K	362	374R/...	34	437K/16	43	621	54
91BA	210	142SN	28	375	34	437K/33	43	641	54
92	21	186 8-32	28	376	34	437U/09	43	642	54
92BA	210	187	28	378	34	437U/E-M...	43	643	54
93	21	188	29	378BA	211	437U/PM	43	652	54
93BA	210	192	29	383	34	438...	43	653	54
93C	21	192/S2	29, 362	383R	34	438A	43	666N	55
93K	361	194	29	384	34	440	44	666N LBF.IN	55
94	21	195	29	384RC	34	440A	44	667N	55
94K	361	195AS	29	386A	34	440ASC	44	668N	55
95	21	195K	362	386A/RC	34	440ASF	44	668RG	56
95BA	210	195P	29	386BA	211	440ASG	44	669N	56
95FTX	21	310	29	388	35	440ASW	44	671B/C5	56
96	21	310B	29	388A	35	440B	44	671B/C10	56
96/BG7	22, 361	310/C4	29	388C/C8	35	441	44	671N/C10	56
96/BGS7	22, 361	310/C8	29	392C	35	441A	44	671N/C20	56
96/SC12	22	311	30	392RG/C	35	441B	45	671N/C30	56
96/SC9	22, 361	330	30	393	35	442	45	677	57
96AS	23	330BA	211	395	35	443	45	677/C	57
96AS/BG7	23	330R/A	30	395T	35	444	45	677/CP200	57
96AS/SC9	23	330R/I	30	399	35	444G	45	678/C	57
96BA	210	331L	30	410	35	446/C110	46	677/CV - 678/CV	57
96BA/BP	210	331LR/L	30	410/SEL	36	446/C30	45	680	57
96BP	24	332	30	410A	36	446/C48	45	682	58
96BP/AS-SC9	24	334	30	410AS	36	446ASC/C37	46	710	58
96BP/SC9	24	334R	30	410AS/SEL	36	446ASF/C29	46	710/16	58

INDICE ALFANUMERICO

710/20	58	860PHZ/A10	64	900AS/L	71	910M/56	78	920ES/SB	83
710/21	58	860PHZ/A31	65	900AS/MB	71	910M/R55	90	920ES/XL-SB	83
710/25	58	860PZ	64, 362	900AS/MB-C17	74	910ME	76	920FTX	81
710/C10	58	860RTX	64, 363	900AS/MBL	71	910ME/SB	76	920FTX/C	81
710/OR... - 710/SP...	58	860RTX/A10	65	900AS/SB11	71	910PE	76	920FTX/L	81
720	58	860TX	64, 362	900BG/30	72	910PE/SB	76	920FTX/LSB	81
720/15	60	860TX/A10	65, 363	900BG/30C	72	910PH	76	920FTX/SB	81
720/16	60	860TX/A31	65	900BG/30K	363	910PT	77	920LH/SB7	81
720/20	60	861/C61P	67	900FL	72	910PT/SB	77	920LP	81
720/21	60	861LP	66	900FTX	71	910TX	77	920M/35	83
720/25	60	861PE	66	900FTX/SB9	71	910TX/SB	77	920M/35L	83
720/C12	60	861PH	66	900K	363	920/15	83	920M/55	84
720/C6	60	861PH/C	66	900L	70	920/16	83	920M/56	84
720/OR... - 720/SP...	61	861PZ	66	900L/SB13	70	920/20 - 920/21 - 920/22	83	920M/R55	90
720AS	59	861PZ/C	66	900LP	71	920/21K		920ME	82
720FTX	59	861RIBE	66	900M/35	72	920/25	363	920ME/C	82
720FTX/SB	59	861RTX	66	900M/55	72	920/25K	83	920ME/SB	82
720IC	59	861SP	67	900M/R55	90	920/35A	363	920MQ/21	202
720L	59	861TQS	67	900MB	70	920/36A	83	920MQ/22	202
720L/S3	59	861TRW	67	900MB/C19	73	920/40	83	920MQ/55A	202
720LC	59	861TX	66	900MB/C28	74	920/42	84	920MQ/A	202
720LC/C3	59	861TX/C	66	900MB/L	70	920/44	84	920MQ/C16	202
720LC/S5	59	861XZN	67	900MB/SB	70	920/46	84	920MQ/PE	202
720LS	59	862F	68	900ME	71	920/50	84	920MQ/T	202
720ME	60	862F/A7	68, 363	900ME/SB8	71	920/50F	84	920PE	81
720ME/C8	60	862LP	67	900PH	71	920/55	84	920PE/AS	82
720MRC	59	862PE	67	900PT	71	920/55K	84	920PE/C	81
720TX	59	862PH	67	900T/44	72	920/55LC	363	920PE/SB	81
720TX/C6	60	862PH/L	67	900TX	71	920/55Q	84	920PH	81
720TC	60	862PZ	67	900TX/SB	71	920/R50	84	920RTX	82
720TC/S5	60	862TX	67	902R/C6	74	920/R55	84	920RTX/SB	82
727/C16	61	862TX/L	68	910/15	77	920/R55LC	84	920TX	82
727/ES16	61	866LP	68	910/16	77	920/R55Q	85	920TX/C	82
727/ES16TX	61	866PE	68	910/21 - 910/22	77	920/R55X	87	920TX/C17	87
727/ES22	61	866PH	68	910/25	77	920A	90	920TX/C17	87
727/ES22TX	61	866PZ	68	910/36A	77	920A/AS	90	920TX/LSB4	82
727/ES32	61	866RTX	68	910/40	77	920A/C11	90	920TX/SB	82
727PI/16	61	866TX	68	910/42	78	920A/C12	90	920XZN	82
727PI/22	61	867/...	69	910/46	78	920A/C17HR	90	920XZN/LS	83
727PI/32	61	867/C52	69	910/55	78	920A/C20	90	920XZN/SB12	83
728	61	867PE	68	910/55Q	78	920A/C21	79	920XZN/SB7	83
728/15	62	867PE/L	68	910/58	78	920A/C21X	80	921BA	211
728/16	62	867RTX	69	910/R55	90	920A/C21X	85	921BA/21 - 921BA/22	211
728/21	62	867RTX/L	69	910/R55Q	90	920A/C21X	85	921BA/25	211
728/22	62	867TX	69	910A	75	920A/C21X	85	921BA/42	211
728/22L	62	867TX/L	69	910A/AS	75	920A/C21X	88	921BA/50	211
728/25	62	867XZN	68	910A/AS	75	920A/C20Q	85	921BA/R50	211
728/C10	62	867XZN/L	69	910A/C10	78	920A/C20Q	85	926BA	211
728/OR - 728/SP	62	882	69	910A/C16	78	920A/C20X	86	926BA/22	211
728FTX	61	882M1	69	910A/C16HR	79	920A/C20X	86	926BA/42	211
728L	62	882M	69	910A/C16Q	78	920A/C21	86	926BA/50	211
728LQ	62	882MSR	69	910A/C17	79	920A/C21	86	926BA/R50	212
728LS	62	882P	69	910A/C17	79	920A/C33	86	928/15	88
729	62	892	70	910A/SB	75	920A/SB13	80	928/16	88
729/15	63	895	70	910A-SB/SB13	75	920A/SB8	80	928/21 - 928/22	88
729/16	63	897	70	910AL	75	920A-SB/SB11	80	928/25	88
729/21	63	897L	70	910AL/SB14	75	920AK	363	928/36A	89
729/22	63	900	70	910AN	77	920AL	80	928/42	89
729/25	63	900/...	72	910AS	75	920AL/SB11	80	928/55	89
729/OR... - 729/SP...	63	900/16	72	910AS/C13	79	920AN	83	928/R55	90
729L	62	900/20LK	363	910AS/L	76	920AS	80	928/R55X	90
729LS	63	900/25	72	910AS/L	76	920AS/C10	87	928/R55X	90
729T	63	900/25K	363	910AS/MBM-C18	79	920AS/C15	87	928A	88
730	63	900/32	72	910AS/SB13	76	920AS/C17X	87	928A/C12	89
730/15	63	900/35A	72	910AS/SN	76	920AS/L	81	928AS	88
733/15	63	900/40	72	910ASL/SB12	76	920AS/MBM-C21	87	928AS/C12	89
850MQ	202, 362	900/42	72	910B	75	920AS/SB11	80	928B	88
851	63	900/55	72	910B/C10	78	920AS/SB11	81	928B/C12	89
851SR	63	900/55K	363	910B/C16	79	920ASL/SB11	81	928ME	88
855P	64, 362	900/58	73	910B/C16Q	79	920B	80	928ME	88
860/55	64	900/C11	73	910B/C29	79	920B/C11	85	929	89
860/58	64	900/C11HR	74	910B/SB	75	920B/C12	85	929/15	89
860/58K	362	900/C13-5	73	910BL	75	920B/C12X	85	929/21 - 929/22	89
860/C27	64, 363	900/C13-8	73	910BL/SB	75	920B/C20X	86	929/42	89
860/C38P	66	900/C24	74	910CF	77	920B/C21	86	929/55	89
860LP	64, 362	900/C39	73	910CF/SB	77	920B/C21X	86	929/C8	90
860MIX/A10	65, 363	900/R55	90	910FTX	76	920B/C30Q	86	929/R55	90
860MIX/A31	65, 363	900/SB	70	910FTX/L	76	920B/C33	87	930	90
860PE	64, 362	900AN	72	910FTX/LSB	76	920B/SB13	80	930/C	91
860PE/A10	65	900AS	70	910FTX/SB	76	920B/SB8	80	930/S	90
860PH	64, 362	900AS/C10	74	910LP	76	920BL	80	932	91
860PHT/A31	65	900AS/C17-MBM	74	910M/35	77	920BL/SB11	80	932/S	91
				910M/55	78	920BP	82	933	91
						920BP/SB	82	933/S	91
						920ES	83	935	91

INDICE ALFANUMERICO

935/S	91	960SN	96	1034K	364	1114	109	1177BM	113
935K	364	960/22EP	96	1034L	104	1118	109	1177BM/Z	113
937	91	960PI/S	98	1036	104	1120A	109	1178BM	113
937/S	91	960W	98	1036BA	212	1120ARL - ARG	109	1178BM/P	113
937BA	212	961BA	212	1036K	364	1112K	365	1182BM	114
937K	364	961D	98	1038K	364	1122	109	1183BM	114
940	92	961D/CF3,8	98	1037	104	1122K	365	1184BM	114
941	92	961D/DC8,5	98	1038	104	1123	109	1185BM	114
941/S	92	961P6	99	1039	104	1123K	365	1186BM	114
942BX	92	961P6/S-2	99	1044	104	1124	109	1188BM	114
942BX/DG	371	962	99	1044F	104	1124K	365	1190BM	114
942BX/S	92	963	99	1044FK	364	1125	109	1191BM	114
943BX	92	963BA	212	1044K	364	1122 - 1125MOL	109	1191BM/L	114
943BX/D	92	964	99	1046	104	1126	109	1200MS	115
943BX/DG	371	964BA	212	1046BA	212	1127	109	1201	115
943BX/S	92	964BA/L	212	1046K	364	1128BAX	110, 365	1201/S	115
943BXK	364	965	99	1047	104	1128BCX	365	1201DZ	115
943FL	92	965/S	99	1047BM	104	1128BM	110	1201K	366
943FL/S	92	965BA	212	1048	104	1128BMX	110, 365	1201N	115
943MQ	202	966/C3	99	1048BM	105	1128BSX	110, 365	1201NK	366
943MQ/BG	371	966BA	212	1048K	364	1128BTX	110, 365	1202	115
943MQ/S	203	966BA/V	212	1048MQ	203	1128MQ	203	1202/S	115
944BX	92	969A	99	1048V	105	1129BM	110	1202K	366
944BX/D	93	969B	99	1048VK	364	1129BMK	365	1202N	115
944BX/DG	371	969/C5	99	1050	105	1130BMX	110, 365	1202NK	366
944BX/S	92	970B	100	1051	105	1131CK	110	1203/D	115
949	93	970C	100	1051GM	105	1132	110	1203/E10P	372
949/S6	93	970EA	99	1051L	105	1132BM	110	1203/E1P	372
950	93	970EB	100	1051XL	105	1132MQ	203	1203/E4P	372
950/S	93	970OT	100	1052	105	1133	110	1203/E5P	372
951	93	970Q	100	1052K	364	1133RL	111	1203/S10	115
951/S	93	971TSP	100	1053	105	1134	111	1204	116
951/SP	93	971/C8	100	1054	105	1134A	111	1204/S	116
951AS	93	978 - 979	100	1055	105	1134A/RL	111	1204K	366
951AS/S	93	982	100	1056	105	1134RL	111	1207TX	116
951K	364	985M	101	1057A	106	1136	111	1207TX/D	116
951MQ	203	985F	101	1058	106	1137BA	212	1207TXK	366
951TX	94	985/B7	101	1060	106	1137BA/RC	213	1208RTX	116
951TX/S	94	986 48	101	1061	106	1142BM	111	1208RTX/D	116
952	94	986 78	101	1062	106	1142BMK	365	1208RTXK	366
952/S	94	987	101	1062AL	106	1142MQ	203	1209PZ	116
952AS	94	987P	101	1062GM	106	1143	111	1209PZ/S	116
952FTX	94	988/K4	101	1063	106	1143R	111	1209PZK	366
952FTX/S	94	989	101	1064	106	1144D	111	1229LP	116
952L	94	990	101	1065F	106	1144D/RG	111	1229LP/S	116
953	94	991	101	1065P	106	1144D/RL	111	1229LPH/A6	116
953/S	94	992	101	1077	106	1144G	111	1229PH	116
953TX	95	993	101	1078	107	1144G/RL	111	1236B	117
953TX/S	95	993G	102	1080D	107	1148A	111	1238B	117
955	95	993MQ	203	1082	107	1148A/R	111	1241	117
956C	95	993PL	101	1082BA	212	1148B	111	1242	117
956E	95	994	102	1082BM	107	1148B/R	112	1243/D7	117
956L	95	994MQ	203	1082BMK	364	1149F	112, 365	1250	117
957	95	994PL	102	1082MQ	203	1150	112	1251	117
959	95	994TF	102	1084	107	1150BA	213	1252/S5	117
959R	95	996	102	1084BM	107	1150BM	112	1253	117, 366
960	95	998	102	1084BMK	364	1150BMK	365	1253A	117
960 E-PI/P	97	999	102	1084MQ	203	1150MQ	203	1254	117, 366
960A	95	999A	102	1088	107	1153	112	1256/20	118
960AD/TP2	98	999B	102	1088BM	107	1162	112	1256/30	118
960AVE	96	999C	102	1088MQ	203	1162BA	213	1256/C36-2	117
960AVL	98	999D	102	1092V	107	1162BM	112	1256LP	118
960BT	96	999E	102	1094V	107	1162BMK	366	1256PE	118
960BT/B	96	999G	102	1095N	107	1162MQ	203	1256PH	118
960CMB	97	1002	102	1096	107	1164	112	1256PZ	118
960CMD	97	1008	102	1096K	365	1164BM	112	1256RTX	118
960EPC	97	1008BM	102	1098	108	1164BMK	366	1256TX	118
960F	96	1009	103	1098K	365	1164MQ	204	1257BE	119
960G	96	1009L/A	103	1098PL	108	1166	112	1257ES	118
960H/C4	96	1009L/B	103	1098PLK	365	1166BA	213	1257ESB/S8	119
960K/AVE	96	1009L/C	103	1101	108	1166BM	112	1257LP	118
960KC-M8	97	1009L/D	103	1101R	108	1166BMK	366	1257LP/S8	118
960KC-M8/M9/M10	97	1009L/DP	103	1102	108	1166MQ	204	1257LPH/S8	118
960KPC	97	1010	103	1104	108	1168	112	1257PH	118
960L	96	1010BM	103	1104R	108	1168BM	112	1257TX	119
960M	96	1010MQ	203	1105	108	1168BMK	366	1257TX/S8	119
960P	97	1031/S4	103	1105T30	108	1168MQ	204	1260	119
960PI	97	1032	103	1105T50	108	1171BM	113	1260/S	119
960PI/P	98	1032BA	212	1105AD-50	108	1172BM	113	1260E	119
960PMC	98	1032K	364	1105/C15T	108	1172BM/P	113	1260EK	367
960S	96	1033	103	1105/C29T	109	1173BM	113	1260K	366
960SL	96	1034	104	1112	109	1175BM	113	1260N	119

INDICE ALFANUMERICO

1260NK	366	1293ES/S	124	1379BA	213	1461/C21G	136	1479RB/2	142
1262	119	1294	124	1379F	129	1461/C22B	136	1479RB/3	142
1262/S	119	1294/S	124	1379F/MR...	129	1461/C23B	136	1479U/13	142
1262E	120	1294K	367	1380	129	1461/C24B	136	1479U/32	143
1262EK	367	1294L	124	1380/MR...	129	1461/C25G	136	1479N/S5	143
1262K	367	1295	124	1380BA	213	1461/C26B	136	1480	143
1262L	120	1295/C14	124	1380BA/MR	213	1461/C27G	136	1481/C12	143
1262N	119	1297TX	124	1380S	129	1461/C28B	137	1481PL	143
1262NK	367	1297TX/D	124	1380S/MR...	129	1461/C29B	137	1481PL/S3	143
1263/D...	120	1297TX/S	124	1380T	130	1461/C30G	137	1482	143
1263/E39	373	1298RTX	124	1381	130	1462/KD	137	1482/8 - 1482/10	144
1263/E40	373	1298RTX/S	125	1381/MR...	130	1462/KI	137	1482A/1	143
1263/E50	373	1298RTXK	367	1381BA	213	1462/KMRC	137	1482A/2	143
1263/E62	373	1299N/PZ	125	1381BA/MR	214	1462/KU	137	1482A/3	143
1263/E70	373	1299N/PZK	368	1381T	130	1462AD/BSC	137	1482B	144
1263/E78	372	1299PZ	125	1385	130	1462AD/SMN	137	1482C	144
1263/E85	372	1299PZ/S	125	1385/MR	130	1463/KIT	137	1483K/22	144
1263/S12	120	1299PZK	368	1390	130	1464T	138	1483KV-PT/S7	144
1264	120	1302	125	1390/MR...	130	1464AP	138	1483/K12	144
1264/S	120	1303	125	1390BA	214	1464IC	138	1484	144
1264K	367	1304	125	1390BA/R	214	1467	138	1485/KIT	144
1264L	120	1305	125	1390N	130	1467/RK1	138	1485R	144
1265ES	120	1305Z	125	1390NR	130	1467/RK2	138	1485R/P10	144
1265ES/S	120	1306	125	1390R	130	1467LF	138	1485R/P17	144
1266BP	121	1307	125	1391	130	1467LF/RC	138	1486/10	144
1266BP/S	121	1308	125	1391A	131	1468N	138	1486/20	145
1267TX	121	1309	125	1392	131	1469C	138	1486/30	145
1267TX/D	121	1310	125	1392R	131	1469C-R	138	1486/40	145
1267TX/S	121	1312	125	1393	131	1470	139	1486/50	145
1267TXK	367	1313	126	1410/M	131	1470FT	139	1486/60	145
1268RTX	121	1314	126	1428	131	1471	139	1486/70	145
1268RTX/S	121	1326	126	1428/SB11	131	1471A	139	1486/80	145
1268RTXK	367	1327	126	1428L	131	1471M/C22	139	1486/90	145
1269N/PZ	121	1328	126	1428L/B3	131	1471M/50	139	1488 - 1488L	145
1269N/PZK	367	1329	126	1429	131	1471M/P	139	1488/1	145
1269PZ	121	1330	126	1429/SB7	131	1471M/W50	139	1489/31T	145
1269PZ/S	121	1331	126	1430/...	131	1471PN/B1	139	1489/33	145
1269PZK	367	1335BM	126	1430/S	131	1471PN/B2	139	1489/33P	145
1270BA	213	1337/S5	126	1433	131	1471PN/B3	139	1489/E	146
1272BA	213	1338A - 1338B	126	1433/C11	132	1471PN/B4	139	1489R	146
1272MQ	204	1338	126	1435	132	1471PN/B5	139	1489/Y	146
1272MQ/S	204	1338R9 - 1338R12	126	1435R	132	1471CF	139	1489/C14	146
1273MQ/D6	204	1342	126	1435/1	132	1471CM	139	1490/1 - 1490/2	146
1273MQ/E1	373	1342PM	126	1435/1R	132	1471CM/E11	139	1490 /R1 - 1490 /R2	146
1274MQ	204	1342PMR	126	1437/C12	132	1471D2	140	1491	146
1274MQ/S	204	1343	126	1438	132	1472	140	1491R	146
1279MQ	204	1345	127	1438R	132	1472AU	140	1491C	146
1279MQ/S	204	1351	127	1438 SAC	132	1472AU/P	140	1492/1 - 1492/2	146
1281/B28A	122	1353	127	1439/K7	132	1472AU/RP	140	1492T	146
1281BG	121	1357Z/45	127	1440/...	132	1472FC	140	1493	146
1281BG/A9	122	1359T	127	1445/1 - 1445/2	132	1472FC/L	140	1493/PF	147
1281BG/B28A	122	1368	127	1450GC	133	1472FCL/RP	140	1493/C30	147
1281BG-TX/A8	122	1368G/OD	127	1452K	133	1472R/AU	140	1493AL	147
1281LP	121	1368G/SD	127	1452PN/K	133	1472TM	140	1493AL 4S	147
1281LPH	122	1368G/CV	127	1455SVP	133	1472VW	140, 368	1493AL CF	147
1281PB	121	1368G/C2U	127	1455SVP/R...	133	1473	140	1493/C19	147
1281PE	122	1369/C11	127	1458	133	1473A	140	1493FF	147
1281PH	122	1370	127	1460F	133	1473Q	140	1493/S-U	147
1281PM	121	1370/MR...	128	1461BF	133	1473P	141, 368	1493T	147
1281PZ	122	1370BA	213	1461/C3B	133	1473FN	141	1493J	147
1281RTX	122	1370BA/MR	213	1461/C5G	133	1474/C4	141	1493Z/1 - 2 - 3	148
1281TX	122	1370F	128	1461/C6B	133	1474E/VW	141	1494	148
1290	122	1370F/MR...	128	1461/C6G	134	1474L	141	1494E	148
1290/S...	123	1370FT	128	1461/C7B	134	1474DL	141	1494M	148
1290K	367	1370T	128	1461/C8B	134	1475U	141	1494Q	148
1290N	123	1374F	128	1461/C8G	134	1476	141	1494T	148
1290NK	367	1374F/MR...	128	1461/C9B	134	1476/RC	141	1494XZN	148
1292	123	1375	128	1461/C10A	134	1476A	141	1494VW	148
1292/S	123	1375/MR	128	1461/C10G	134	1476A/RC	141	1494/C14A	148
1292K	367	1375A	128	1461/C11A	134	1476C/1 - 1476C/2	141	1495/C6	148
1292L	123	1375B	128	1461/C11G	134	1476GT	141	1495M	148
1292N	123	1375BA/PL	213	1461/C12A	135	1476PSA	141	1495T	148
1292NK	367	1376X	128	1461/C12G	135	1476T	142	1496/A	148
1293/D...	123	1376X/MR	129	1461/C13A	135	1477/C10	142	1496/C	149
1293/S...	123	1376XT	129	1461/C13B	135	1477D	142	1497D	149
1293BP	124	1376XT/MR	129	1461/C16	135	1477D/S5	142	1497P	149
1293BP/S	124	1377	129	1461/C17	135	1477K/7	142	1497/C23	149
1293BX/DA	374	1377/MR...	129	1461/C17B	135	1478	142	1497/C94	149
1293BX/DD	374	1377BA	213	1461/C18	135	1478T	142	1497RC	149, 368
1293BX/DE	374	1377BA/PL	213	1461/C18B	135	1479	142	1498	149
1293BX/DF	374	1378	129	1461/C19	136	1479/B27	142	1498MN/12	149
1293ES	123	1378/MR...	129	1461/C20G	136	1479RB/1	142	1498MN/12-C	149

INDICE ALFANUMERICO

1498/12	149	1580/8I	158	1670	165	1717A	171	1742A	176
1498/24	150	1580GL	158	1670A	165	1717B	171	1742A/C	176
1498B12/R02	150	1585/5I - 6I - 7I	158	1672	165	1717BA	214	1742A/KR	176
1498C/24	150	1585GI/5 - 6 - 7	158	1672A	166	1717BA/1	214	1742KR	176
1498/4A	150	1589VI	158	1674A	166	1717C	171	1742R-A/M...	176
1498/8A	150	1589PI/50 - 100 - 150	158	1676	166	1717D	171	1742R-AL/M...	176
1498/40A	150	1590	159	1678/C3	166	1718A...M	171	1743	176
1498/50A	150	1591	159	1679	166	1718A...P	171	1743T	176
1498SM	151	1593	159	1679 /PR	166	1718A...Q	171	1748/...K	177
1498TB/12	151	1594	159	1680	166	1718A...R	172	1748B/...K	177
1498ST/TB	151	1595	159	1680A	166	1718A...T	171	1749	177
1498TC	151	1599B	159	1680B	166	1718A...S5	172	1749A	177
1499	151	1599F	159	1680C	166	1718D...M	171	1749A/RB	177
1500/...	151	1599G	159	1682	166	1718D...P	171	1749A/RT	177
1500/SP	151	1599P	159	1683	166	1718D...Q	171	1749AC	177
1500G/...	152	1599T	159	1685/C7	167	1718D...R	172	1750	177
1500N/...	152	1601/PC	159	1687A	167	1718D...T	171	1750CG	177
1500N/SP	152	1602	159	1687AC	167	1718D...S5	172	1750M	178
1500N/G...	152	1602/C9T	160	1687D	167	1719BA8	214	1750R/1 - 1750R/2	177
1501/1 - 2 - 3	152	1602A	160	1687U	167	1719BM/RL	173	1750RC	177
1501G/1 - 2 - 3	152	1602BA	214	1687/S4	167	1719BM/RR	173	1750RP/1 - 1750RP/2	177
1501Z/S - P - R	152	1603	160	1688	167	1719BMA...M	172	1750RT	177
1505V	152	1603A	160	1688A	167	1719BMA...P	172	1751	178
1505/C5	152	1603B	160	1688PC	167	1719BMA...Q	172	1751R	178
1506	152	1603BK	368	1688PC/R	167	1719BMA...R	173	1752	178
1508/1 - 1508/2	153	1604	160	1688M	167	1719BMA...T	172	1752R	178
1511/1 - 2 - 3	153	1604/C9T	160	1690F	167	1719BMA...S5	173	1753	178
1515/1 - 2 - 3	153	1605	160	1690L	167	1719BMB/P	173	1753R	178
1516/1 - 2 - 3	153	1606	160	1691BM	167, 368	1719BMC	173	1754	178
1517	153	1606A	160	1692	167, 368	1719BMD...M	172	1755	178
1518/...	153	1606A/C9	161	1694/L	168	1719BMD...P	172	1756	178
1520/1 - 1520/2	153	1607	161	1694A/L	168	1719BMD...Q	172	1756B	178
1521/1 - 1521/2	153	1608	161	1694B/L	168	1719BMD...R	173	1756C	178
1529	154	1608/C9T	161	1695 XS	168	1719BMD...T	172	1756D	178
1529PI	154	1608A	161	1696	168	1719BMD...S5	173	1756C-2OR	178
1530/C5	154	1609	161	1696A	168	1719BMX...M	172	1756D-2OR	178
1532	154	1609A	161	1696B	168	1719BMX...P	172	1757	179
1533/...	154	1609B	161	1696D	168	1719BMX...Q	172	1757A	179
1533PR/1 - 2 - 3	154	1609C/C5	161	1696S	168	1719BMX...R	173	1758A	179
1534/...	154	1609M	161	1699L	168	1719BMX...T	172	1758LG	179
1535/C...	154	1610	162	1699L/1	168	1719BMX...S5	173	1758M	179
1539	154	1614	162	1699Q	169	1719BMR	173	1758R	179
1540	155	1616	162	1700N	169	1719/...	173	1758VT	179
1542/1 - 1542/2	155	1618	162	1700N/PM	169	1719BA12	214	1758VT/L	179
1544/...	155	1620	162	1701BA	214	1720/...	173	1759	179
1545/C5M	155	1622	162	1701N	169	1720/B	173	1759A	179
1547/C6	155	1624	162	1701N/PM	169	1720/S	173	1759B	179
1547KP	155	1628	162	1701NE/...	169	1720D/...	174	1759HD/3	180
1547P	155	1630	162	1701PMR	169	1720D/B	174	1759HD/RR	180
1547PC/2	155	1632	162	1702N	169	1721/B6	174	1759HD/TRUCK	180
1547PL/2	155	1634	162	1702N/PM	169	1723	174	1759TT	180
1549	155	1639NS-N	163	1702PMR	169	1725	174	1760/IR1600	182
1550U	156	1639S	163	1703BA/A	214	1725CR	174	1760/IR800	182
1550U/S...	156	1640K	163	1703BA/P	214	1725MQ	204	1760/OHM	180
1550U/M	156	1640	163	1703BA/PL	214	1726	174	1760/RMS	181
1555/Q	156	1640A	163	1704	169	1726BM	174	1760/TC2	181
1555/QS	156	1640P	163	1704A	169	1727	174	1760B	180
1555S/MRC-C	156	1640Q	163	1704C	169	1727BA	214	1760DGT	180
1555S/BMW-RNT	156	1640T	163	1705	169	1727BM	174	1760PA/80	181
1555C	156	1650	163	1705PT	170	1728...	174	1760PA/AC	181
1556/1A	156	1650FD	163	1706DGT	170	1728BA	214	1760PA/AC-DC	181
1556/2A	156	1650FT	163	1707	170	1729	174	1761	182
1557	157	1651DGT	163	1707A/1 - 2 - 3	170	1729CG	174, 368	1761RS/1	182
1557V	157	1651DGT/IP	163	1708/8 - 13 - 20	170	1729DM 450	174, 368	1762	182
1557/S3	157	1652	164	1709/10 - 1709/18	170	1729LR	174	1762K	368
1559	157	1654	164	1710	170	1736A	174	1765/C24	182
1559V/8T	157	1654DGT	164	1712E/1 - 2 - 3	170	1737	174	1766	182
1560/1 - 1560/2	157	1656	164	1712E/L1	170	1737AC	175	1766 LI	183
1560A	157	1657DGT/2	164	1712E/R-L1	170	1737B	175	1766 T	183
1561/...	157	1658/...	164	1712TF	170	1737BA	214	1766/8	182
1562D	157	1658/C4	164	1713M	170	1737NX	175	1766A	182
1565/1 - 2 - 3	157	1658DGT	164	1714	170	1738	175	1766ER	182
1566N	157	1658SP/1	164	1715	170	1739B	175	1766G	183
1566/GO1	157	1659	164	1715FL/A	170	1740A	175	1766I	183
1566P	157	1662/1 - 1662/2	164	1715R/FL	170	1740B	175	1766L	182
1567	157	1662DGT	164	1715FL/B	171	1741B	175, 368	1767PMC	183
1568/C15	157	1662AN	165	1715B/R5L	171	1741B/C5	175	1767PMR	183
1568R/CS3	158	1662SP0	165	1716A	171	1741BP	175	1770	183
1569/A	158	1662SP2	165	1716P	171	1741RV...K	176	1770A	183
1569/F	158	1666	165	1716Q	171	1741U	175, 368	1770B	183, 368
1569CP	158	1666A	165	1716R	171	1742	176		
1570/3	158	1668A	165	1716U	171	1742/C4	176		

INDICE ALFANUMERICO

1770RL	183	1846R-LED/BM	190	1927XM	217	2009N/BV	231	3041T	199
1771	183, 368	1847K	190, 368	1928CD	218	2009ID	231	3041T/17	199
1771BM	183, 368	1847P	190	1928DA	218	2029/VV	231	3042	199
1771RL	183	1848	190	1928DAL	218	2029E	231	3042/K6P	199
1772H	183	1850B	190	1928K4	218	2029/RT	231	3043	199
1772R	183, 369	1850C	190	1930A	219	2032/VV	231	3043A/41÷47	199
1772RL/2	183	1850U...	190	1930CD	218	2032E	231	3061/2T	199
1773A	184, 369	1851VK	190	1930HLA	219	2032/TV	231	3061 /2T-P50	200
1773RL	184	1851VK-12C	190	1930LA	219	2032/TE	232	3061 /2T-P100	200
1774	184	1852 R1750	191	1930NCD	218	2033 P/VV	232	3063/2,5T	200
1774A	184	1852 S-L	191	1930PA	219	2033E	232	3065/40-20T	200
1774A/RL	184	1852 S-F	191	1930ZL	219	2036/TV	232	3067/70-13T	200
1776BA	214	1852 S-FLESS	191	1931AN10	220	2036E	232	5700LAMP	273
1777BM	184	1852 S-PIATTE	191	1931CD6	219	2041UC	232	5902MT	325
1777BMT	184, 369	1860K/160A	191	1931CD10	220	2051N	232	5902MT/AS	326
1777MQ/C	204	1860R/C	191	1931CD13	220	2055HB	233	5902VI	294
1777MQ/U	204	1870	192	1932B10	220	2060/VV	233	5904VG/1M	327
1777RL/U	204	1870-20/5S	192	1932B13	220	2080 /V6	233	5904VG/2M	328
1777T	184, 369	1870-72 /FC	192	1932RS13	220	2080/V6-U	233	5904VG/2T	329
1778	184	1870-72/FL	193	1933	221	2080/V12	233	5904VG/3	330
1778 CM	184	1872	192	1933AN90	221	2080 /V12-S	233	5904VG/5T	331
1778D	184	1872 35/5S	193	1933I	221	2115P L-MQ32	203	5904VI/1T	295
1778SAFE	184	1873	192	1933IL	221	2252	194	5904VI/2T	296
1778SCL	184	1873 30/5S	193	1933L	221	2252KR4	194	5904VI/3T	297
1778SOS	184	1874	192	1934BV	221	2300ST/KIT	239	5904VU/1M	304
1778W	185	1874 50/FC	193	1934MAV	221	2499S-R/PC	249	5904VU/2M	305
1778X	185	1874 50/5S	193	1934MAV70	221	2400S/PF	249	5904VU/3T	306
1781	185	1877	193	1935F	222	2499PC	250	5905VG/1	332
1783	185, 369	1877A	193	1936/4A	222	2499PF	249	5905VG/2	333
1784	185	1878 3	193	1936/5	222	2499PF/M	250	5908VG/2T	334
1784BA	214	1878 11	193	1936/5A	222	3000M/LT	195	5908VI/2T	298
1800/100	185	1878 30	193	1936/7	222	3000M/RLS	195	5910VG/3T	335
1808	185	1879	193	1937	222	3000S/PLM	254	5910VI/3	299
1812 150	185	1879R/K4	194	1937M	223	3002	195	5910VI/3T	300
1814M	185	1880	194	1937M-01÷11	223	3002/RLS	195	5915VU/0	307
1820	185, 369	1881	194	1937N10	223	3003	195	5915VU/1	308
1822	185, 369	1882	194	1937N10-GR	223	3003/RLS	195	5915VU/2	309
1823 60	185	1883	194	1937N20	223	3007	195	5915VU/3	310
1823R/60	186	1883NC	194	1937N20-GR	223	3008	195	5915VU/4	311
1824R	186	1884	194	1937R/P	222	3009	195	5915VU/5	312
1825B	186	1884/C12	194	1937/KL	223	3009R/GR4	195	5915VU/AS	313
1827	186	1889	194	1937/KL-D	223	3010/T...	195	5927VU/M	314
1827PC	186	1901BM/8	227	1938	223	3011/T	196	5938U/2T	315
1827PCL	186	1901T/10	227	1938R/L	224	3012	196	5940SBK	336
1827PFL	186	1910/8 - 1910/10	227	1938R/S5	224	3012C	196	5953VG	337
1827/K	186	1914	227	1940	224	3012I	196	5953VI	301
1830T	186	1915B	228	1940E10	224	3014	196	5954VG	338
1834L/USB	186	1915C	228	1940E10/MT	224	3014R/GR5	196	5954VI	302
1834 RB-L/USB	186	1915C/L	228	1940E10/S...	224	3014SAR	196	5955U	316
1834PS	186, 369	1915D	228	1940E10/S5	224	3014SAR/RR	196	5957U	317
1834PM	186, 369	1915E	228	1940MT	224	3014SAR/1	196	5957VG	339
1834PL	186, 369	1915E/XL	228	1940S...	224	3014SAR/2	196	5957VI	303
1834PXL	187, 369	1916I	228	1940/S5	224	3025	196	5958U	318
1835/1	187	1916G	228	1942A	224	3025/PF	197	5980ET/A	319
1835/2	187	1917M	228	1942LR	224	3025/RF	196	5980ET/B	320
1836A	187	1917F	228	1944	225	3025/RG	197	5980/MQ	321
1836 B	187, 369	1917RS	228	1944AR	225	3026 0,3	197	5980 EL/A	322
1837N	187, 369	1919FE1/4	228	1946	225	3026 0,5	197	5980 EL/B	323
1837/USB	187	1919RB-FE1/4	228	1946C4,8	225	3026 1,0	197	5980ID	324
1837+	187	1919RF-FE1/4	229	1946C7,8	225	3026/R0,3	197	6200AP/S10	419
1837RB/USB	187	1919RM-FE1/4	229	1946KF	225	3026/R0,5	197	6600 E/A10	381
1838 COB	188, 369	1919F1/4	229	1946 KF/M...	225	3026/S	197	6600 E/A20	381
1838FLASH	188	1919F3/8	229	1947	225	3026/SP	197	6600 E/A30	381
1838P	188, 369	1919F1/2	229	1947H	226	3027 10	197	6600 E/B10	381
1838/11LED	188	1919RB-F	229	1948	226	3027 20	197	6600 E/B20	382
1838LED/120	188	1919RF-F	229	1948PR	226	3027 30	198	6600 E/C10	382
1838LED/120-AL	188	1919RM-F	229	1949BC	226	3027 50	198	6600 E/K20	382
1838RA/10-11LED	188	1919ML	229	1949BC/RU	226	3027/KP	198	6600 M/11	375
1838RB/10LED	188	1919SC	229	1949DGT	227	3027/KPP50	198	6600 M/22	375
1838RB/FLASH	188	1919L	229	1949F	226	3030/2T	198	6600 M/27	375
1838RR/11LED	188	1921B1	216	1949G	226	30302T/R5	198	6600 M/38	375
1838RV/11LED	188	1921M1	216	1949GPE	227	30302T/R6	198	6600 M/39	376
1838SL	189	1921M2	216	1949GPN	227	3030/2TRP	198	6600 M/40	376
1838UV	189	1921N3	216	1949M	227	3033/3T	198	6600 M/47	376
1839/R...	189	1921I	216	1949T	226	3035	198	6600 M/51	376
1840BM	189	1924B	216	1951	227	3040	199	6600 M/52	376
1842LED/ABM	189	1924CD	216	1995MQ/G1 - G2	204	3040A/1	199	6600 M/58	376
1842LED/BM	189	1927A	217	1995MQ/T	204	3040A/2	199	6600 M/61	376
1843BM	189	1927AN	217	2001/B26	231	3040A/6-8-10	199	6600 M/63	376
1843R/BM	189	1927CD	217	2001/BV	231	3041	199	6600 M/73	376
1846LED/ABM	190	1927P	217	2005PA/D	231	3041A/11	199	6600 M/112	376
1846LED/BM	189	1927SP-AM	217	2005PA/S	231	3041A/15	199	6600 M/116	376

INDICE ALFANUMERICO

6600 M/120	376	7328EN	387	7685	410	8026A	426, 449	8188F	442
6600 M/125	377	7235B	391	7685BL	410	8026R	427, 450	8188FG2	443
6600 M/126	377	7236B	391	7733	410	8028	427, 450	8188FG3	443
6600 M/131	377	7248G	392	7734	411	8029	427	8188F/35	442
6600 M/172	377	7249G	392	7780N	411	8029R	427, 450	8189	443
6600 M/216	377	7250NKK	392	7800G	418	8031R	428, 450	8189PA	443
6600 M/221	377	7251NKK	393	7815N	407	8032	428, 450	8201T	443
6600 M/230	377	7252NKK	393	7816BL	408	8040EN	428, 450	8205	443
6600 M/234	377	7253NKK	393	7816G	408	8040EZ	428, 450	8206	443
6600 M/241	377	7258NKK	393	7816ST	408	8041	429, 450	8207	443
6600 M/244	377	7259NKK	394	7820	414	8042EZ	429, 450	8209	443
6600 M/311	377	7290AKK	399	7821	414	8042EN	429, 450	8210	444
6600 M/315	377	7291AKK	400	7823	415	8043	430, 450	8216	444, 450
6600 M/320	378	7293NB	401	7825	415	8044	429	8220	444
6600 M/326	378	7293NG	401	7829	415	8048	430	8225	444
6600 M/327	378	7293NKK	401	7840BL	411	8049	430	8227	444
6600 M/330	378	7294NB	402	7849BL	411	8050D	434	8228	444
6600 M/370	378	7294NG	402	7860E	411	8051S	432, 450	8240	444
6600 M/378	378	7294NKK	402	7861E	411	8052	433	8240F	445
6600 M/417	378	7294TKK	402	7863E	412	8057	433	8242	445
6600 M/418	378	7295	403	7865E	412	8057R	433	8242F	445
6600 M/427	378	7300B	400	7867E	412	8058	433	8248	445
6600 M/430	378	7300BKK	400	7869E	412	8058R	433	8249	445
6600 M/440	378	7310BKK	391	7870E	412	8060	433	8249G	445
6600 M/456	378	7313B	394	7871E	412	8060R	433	8250	445
6600 M/464	379	7313G	394	7873E	413	8061F	433	8264	445
6600 M/480	379	7313T	394	7875E	413	8061R	433	8267	446
6600 M/485	379	7316N	395	7877E	413	8062	433	8272	446
6600 M/510	379	7318ESD	400	7879E	413	8063	434	8273	446
6600 M/528	379	7320M	395	7900E	413	8064S	434	8274	446
6600 M/532	379	7323M	395	7901E	413	8065SC	434	8274A	446
6600 M/542	379	7327NKK	403	7903E	414	8074	430	8274G	446
6600 M/561	379	7327R	403	7905E	414	8080	430	8276	446
6600 M/583	379	7330NV	403	7904E	414	8082	430	8276G	447
6600 M/619	379	7334T	395	7907E	414	8083	430	8278	447
6600 M/637	379	7340B	398	7909E	414	8085	434	8280	447
6600 M/650	379	7340Y	398	7930P	415	8086	435	8282	447
6600 M/657	380	7341N	398	7930P	415	8090	435	8284	447
6600 M/658	380	7349RP	399	7931P	415	8090F	435	8285	447
6600 M/715	380	7350RP	399	7933P	416	8091	436	8286	447
6600 M/814	380	7360UN	396	7935P	416	8092	436	8287	448
6600 M/840	380	7361UB	396	7939P	416	8094	437	8290	448
6600 M/841	380	7361UM	396	7970 blu	416	8096	437	8293	448
6800 VE	375	7368UG	397	7971E	416	8097	437	8297C	448
6888	375	7368UM	397	7973 blu	416	8098	438	8297F	448
7042LCD	191	7368UN	397	7978E	417	8100	435	8300	431
7042LCD/RV	191	7369UB	397	7979 blu	417	8105	424, 449	8302Z	431
7042LCD/RV-INT	191	7398AL	404	7981T	418	8109	424, 449	8303Z	432
7051MP	418	7398BF	404	7984	418	8114	431	8317DZ	426
7061TC	418	7398CX	404	7985	418	8116	431	8317SZ	426
7076BC	418	7398GEL	404	7991N	417	8120	431	8345	431
7076BD	418	7398ST	404	7992N	417	8130	431	8381SL	432
7076BP	418	7398 TNT	405	7993	417	8131Z	431	8381SP	432
7076BU	418	7399 A/N...	405	7994	417	8139Z	431	8381SX	448
7093BC	418	7399B...	405	8001Z	422, 449	8150	438	8383C	432
7093BD	419	7399G...	405	8001TZ	422, 449	8153	438	8383P	432
7190C	418	7399M...	405	8002ZD	422	8156	438	8515V	432
7195A	418	7410	405	8002ZS	422	8157	439	8515Z	432
7200BKK	388	7413	405	8003ZD	423	8158	439	8531	427
7200PN	388	7417	405	8003ZS	423	8159	439	8532	427
7201BKK	389	7415	405	8004ND	422	8160	439	8535	432
7201PN	389	7416	405	8004NS	422	8161	439	8600 E/R	381
7208WR	389	7418	405	8005TZ	423, 449	8166	441	8600 R/10	380
7210BKK	389	7505M	407	8005Z	423, 449	8170	439	8600 R/112	380
7210PB	390	7515M	407	8006Z	423, 449	8173	440	8600 R/224	380
7211PG	390	7525	407	8007Z	423, 449	8176	440	8600 R/411	380
7216BKK	390	7526	407	8008N	424, 449	8177	440	9504	452
7216SN	390	7546BL	408	8009FD	423	8178	440	9505	452
7220PE	387	7546G	408	8009FS	423	8179M	440	9507D	452
7221PE	387	7546N	408	8009TZ	424, 449	8179B	440	9507U	452
7224PE	388	7548BL	409	8009Z	424, 449	8179A	441	9508K	452
7241B	384	7548G	409	8010Z	424, 449	8180	441	9510	452
7241C	384	7548N	409	8016	425, 449	8181	441	9521	455
7241FT	384	7575A	410	8016DA	425	8182	441	9521W	455
7243B	385	7577N	410	8016DF	425	8182A	441	9524SC	457
7243C	385	7578G	410	8016FR	425, 449	8182E	441	9525C	455
7243CR	385	7622G	409	8016U	425, 449	8182S	441	9525R	455
7243FT	385	7632G	409	8018E	425	8185	442	9525/N	455
7245B	386	7635G	409	8018T	425	8186	442	9525/B	455
7246B	386	7635N	409	8020	426	8187	442	9527 6T	459
7247B	386	7683	410	8021	426	8188C	442	9527MUG	459
7328EA	386	7684	410	8025	426, 449	8188CG/25	442	9533N	452

INDICE ALFANUMERICO

9534B	453	C11	235	C55 LMP/2	288	M174	344	T105	351
9534W	452	C12 - 2112	235	C55 MA	282	M180	344	T106	351
9535	453	C13	235	C55 MS	282	M199	344	T110	351
9537N	453	CP15	235	C55 M2	282	M202	345	T112	351
9539C/B	455	CP15L	235	C55 M7	281	M204	345	T113	351
9541	454	2115P L-MQ32	235	C55 P	287	M208	345	T120	351
9541F	454	C16 - 2116	235	C55 PM	288	M210	345	T131	351
9541BIKE	454	CP17 - CP17L - 2117	235	C55 PM/S	289	M211	345	T132	351
9542	456	C18 - 2118	236	C55 PSP	287	M212	345	T135	352
9542A	456	C19-2119-C19L-2119L	236	C55 P/SP	287	M215	345	T136	352
9542AL	456	C20 - C20L - 2120	236	C55 2PF	289	M220	345	T140	352
9542G	456	C22B	236	C55 2PM	288	M226	345	T142	352
9542S	456	C22P	236	C56	275	M227	345	T145	352
9543S	456	C22S - 2200S	237	C56M	275	M230	346	T146	352
9543W	457	C22W	236	C56W	275	M234	346	T151	352
9544	454	C23S - 2300S	237	C57S A - 5700SA	271	M236	346	T153	352
9545	454	C23SC - 2300SC	238	C57S B - 5700SB	272	M237	346	T154	352
9547	458	C23ST - 2300ST	238	C57S C	272	M240	346	T155	352
9547T	457	CB/2	359	C57S D	271	M264	346	T160	352
9547WSK	457	CD23S	239	C57SP - 5700SP	273	M285	346	T161	352
9549PB	458	C24S/5 - 2400S5	240	C58P - 5800P	274	M287	346	T164	353
9549USB	458	C24S/6 - 2400S6	241	C58M	276	M289	346	T167	353
9557N	454	C24S/7 - 2400S7	242	C58M/PA	276	M295	347	T168	353
9557J 2.0	454	C24S/8 - 2400S8	243	C59A - 5900A	276	M300	347	T170	353
9557SB	454	C24SA/6 - 2400SA6	244	C59B - 5900B	277	M310	347	T171	353
9559	458	C24SA/7 - 2400SA7	245	C59C - 5900C	277	MB	359	T172	353
9559/30MT	458	C24SA/8 - 2400SA8	246	C62EV/CP	419	S42/18	359	T173	353
9560A	457	C24SA-XL/7	247	C62M/W	419	S951/6	359	T175	353
9561V	457	C24SA-XL/8	248	C63 E/W	419	SB	359	T176	353
9562L	457	C24SL - 2400SL	251	C63 G/C	419	SGN	359	T177	353
9562P	457	C25 - 2500	251	C68	374	SP G9 - SP G11	359	T180	353
9563P	458	C27S	252	C68 G	374	SL1 - SL2	358	T183	354
9564B	453	C28 - 2800	253	C88 R/1	375	SL3 - SL4	358	T198	354
9564G	453	C30S - 3000S	254	C88VE	375	SL/C38	358	T199	354
9564X	453	C31	255	KIT/GPS	359	SL/C41	358	T201	354
9569P	460	C38 - 3800	256	GA	358	ST/C38-C	358	T202	354
9569S	460	C38C	258	GA/C38-C	357	ST/C38-DX	358	T204	354
9572MB	452	C38L	257	GA/C38-SX	358	ST/C38-SX	358	T205	354
9574B	454	C38LA	257	GA/C38-DX	358	ST/C41	358	T206	354
9574O	454	C38T	257	GA/C41	358	ST1 - ST2	358	T207	354
9575	458	C39/6 - 3900	259	GL1 - GL2	358	T10	347	T208	354
9577M	458	C39/7 - 3900	260	GL3 - GL4	358	T15	347	T209	354
9579C	458	C39/8 - 3900	261	GM	359	T16	347	T210	355
9581	459	C39SM	263	MC10	340	T18	347	T212	355
9582LE	458	C39T	262	MC20	340	T19	348	T215	355
9582LI	458	C39MD	264	M10	340	T22	348	T220	355
9586K	459	C41S - 4100S	265	M15	341	T23	348	T226	355
9587 9x14	460	C41H - 4100H	265	M16	341	T31	348	T227	355
9587 13x21	460	C42S	266	M30	341	T33	348	T228	355
9588M	459	C42H	266	M33	341	T34	348	T231	355
9588S/10...	460	C41H/CE	267	M38	341	T40	348	T233	355
9588/10PI	460	C42 MCH	267	M40	341	T41	348	T234	355
9589A/36	460	C41MS	267	M45	341	T45	348	T236	355
9589B/36	460	C51	268	M46	341	T46	348	T239	355
9590B	458	CP51	268	M50	341	T48	348	T241	356
9592B/C50	459	C53 - 5300	269	M52	341	T50	348	T250	356
9592B/P	459	C54 - 5400	270	M53	341	T52	349	T256	356
9593B	453	C55	292	M55	342	T53	349	T259	356
9593CA	453	C55 A1	289	M60	342	T55	349	T264	356
9593CV	453	C55 A1/R42	289	M63	342	T56	349	T270	356
9594	459	C55 A2	290	M65	342	T57	349	T273	356
9595C	459	C55 A2/R70	290	M69	342	T59	349	T281	356
9595 C25	459	C55 AB/2	291	M75	342	T63	349	T285	356
9595T	459	C55 AB-PRO/1	291	M79	342	T64	349	T287	357
9596	459	C55 AN/K-P	283	M82	342	T65	349	T289	357
9597P	457	C55 AN/K-PC	283	M83	342	T68	349	T291	357
9598A	455	C55 B	280	M85	342	T73	349	T297	357
9598B	455	C55 B-PRO	280	M86	343	T75	350	TL1 - TL2	358
9599CB	455	C55 B/1	284	M91	343	T76	350	TL3 - TL4	358
9599CB-W	455	C55 B-PRO/1	284	M92	343	T77	350	TSPP	359
C04 TSS-7	239	C55 B/2	284	M100	343	T79	350	VE1	359
C1 - C2	358	C55 B-PRO/2	284	M112	343	T80	350	VP1 - VP2	357
C3 - C4	358	C55 B/3	285	M120	343	T81	350	VP3 - VP4	357
C4 - 2104	233	C55 B-PRO/3	285	M121	343	T82	350	VP5	357
C5 - 2105	233	C55 B/4	285	M130	344	T83	350	VP6	357
C6T - 2106	234	C55 B-PRO/4	285	M131	344	T85	350	VP-3SC	357
C7 - 2107	234	C55 B/5	286	M132	344	T91	350	VP-LD	357
C8 - 2108	234	C55 B-PRO/5	286	M135	344	T92	350	VP-LS	357
C9 - 2109	234	C55 B/6	286	M145	344	T100	351	VPM0	347
C9/RT	234	C55 B-PRO/6	286	M153	344	T101	351	VPM3	347
C10 - 2110	234	C55 C7	281	M170	344	T102	351		
C10S - 2110S	234	C55 LMP/1	288	M172	344	T103	351		

CONDIZIONI GENERALI DI VENDITA

Gli ordini trasmessi per l'acquisto di prodotti dalla Beta Utensili SpA (d'ora in poi "Beta" o "Società") comportano l'accettazione automatica e senza riserve delle presenti Condizioni Generali di Vendita che costituiscono parte integrante del contratto di vendita. Eventuali deroghe alle stesse saranno efficaci solo se concordate per iscritto dalle parti e limitatamente alle vendite cui si riferiscono.

PRODOTTI

I pesi, le dimensioni, i prezzi, i colori e gli altri dati figuranti nei cataloghi, prospetti, circolari, od altri documenti illustrativi della Società, hanno carattere di indicazioni approssimative.

Beta si riserva di variare in qualsiasi momento, senza preavviso, i dati tecnici o costruttivi dei suoi prodotti.

ORDINI

Le presenti Condizioni Generali di Vendita si intendono approvate dall'acquirente con la trasmissione dell'ordine, ordine che viene ricevuto dalla Società sempre con la clausola "salvo approvazione della casa". Beta può accettare l'ordine mediante spedizione della merce, conformemente all'art. 1327 c.c..

Nell'ordine deve essere specificato il codice dell'articolo e la relative quantità.

Le quantità minime sono indicate nel listino per ciascun articolo. Ordini non corrispondenti ad esse, od ai loro multipli, verranno automaticamente adeguati senza previa autorizzazione al Cliente.

RIMANENZE

La Società si riserva la facoltà di evadere l'ordine tutto o in parte ovvero in diverse riprese. Nell'eventualità di ordini non completamente evasi Beta invierà tramite e-mail una distinta riepilogativa delle rimanenze di detti ordini che, salvo espressa richiesta contraria, saranno incluse nella o nelle spedizioni successive. Previa specifica richiesta del Cliente tali informazioni verranno trasmesse via fax.

TERMINI DI CONSEGNA

Eventuali termini di consegna, comunque e dovunque previsti, avranno valore puramente indicativo. La Società declina ogni responsabilità per il caso di ritardo nella consegna che non derivi da suo dolo o colpa grave. Il mancato rispetto dei termini di consegna, purché contenuto in un ragionevole lasso di tempo, non dà diritto al Cliente di richiedere un risarcimento, né di annullare gli Ordini, a meno che, avuto riguardo alla normale tollerabilità ed alla natura del contratto ed alla fornitura, la stessa non abbia più importanza per il Cliente. In questo caso l'onere probatorio sarà a carico del Cliente stesso.

Salvo il caso di dolo o colpa grave della Società, è espressamente escluso qualsiasi risarcimento del danno per mancata o ritardata consegna dei prodotti.

GESTIONE ORDINI, SPEDIZIONI E IMBALLI

Le spedizioni sono effettuate franco destino, con mezzi di trasporto a scelta della Società per gli ordini netti superiori ad € 600,00.

Per gli ordini inferiori ad € 600,00 verrà addebitato a titolo di contributo spese di trasporto il seguente importo:

contributo fisso di € 10,00 fino ad € 199,99

contributo pari al 3,50% da € 200,00 ad € 599,99.

L'imballo è gratuito quando non richiesto di tipo particolare.

Il trasferimento dei rischi relativi ai prodotti ha luogo al momento della loro consegna al Vettore: conseguentemente, i prodotti viaggiano a rischio e pericolo del destinatario anche in caso di spedizione porto franco.

L'Acquirente che sia già cliente abituale potrà utilizzare il **nostro servizio rapido** anche per quantità diverse dall'unità di confezionamento previste. Il costo del servizio verrà addebitato nella misura forfetaria del 6% in sede di fatturazione e le spese di spedizione saranno a carico del Cliente.

PREZZI

L'indicazione di prezzo contenuta in cataloghi, listini, ecc. è meramente indicativa e potrà quindi subire variazioni senza necessità di preventiva informazione. Salvo diverso accordo tra le parti, la merce sarà fatturata ai prezzi in vigore al momento della spedizione.

I prezzi si intendono al netto di iva, di eventuali imposte o tasse, nonché di tributi, diritti ed oneri fiscali o di qualsiasi specie eventualmente gravanti sul contratto che restano a carico esclusivo del Cliente.

PAGAMENTI

Il pagamento deve essere corrisposto direttamente presso la sede della Società in Via Volta n. 18 - 20845 SOVICO (MB) ovvero alla persona munita di autorizzazione scritta con le modalità e nei termini indicati nella fattura.

Sconti per pagamenti a breve termine vanno calcolati sull'importo netto della merce, escluso imballo, spese postali o di trasporto e iva. Trascorsi 15 giorni dalla data della fattura o dal periodo concordato, si intende revocato il beneficio dello sconto condizionato e pertanto la rimessa andrà effettuata per il totale della fattura. Il ritardato pagamento rispetto alla data pattuita darà luogo all'addebito degli interessi di mora di cui all'art. 5 del D.Lgs. 231/02 e produrrà la perdita per il Cliente del beneficio del termine ai sensi dell'art. 1186 cod. civ., rendendo immediatamente esigibili eventuali somme non ancora scadute.

Il Cliente non è autorizzato ad effettuare alcuna deduzione dal prezzo pattuito (ad es. in caso di pretesi difetti dei prodotti), se non previo accordo scritto con la Società.

GARANZIA

I prodotti venduti da Beta sono garantiti in relazione a vizi o difetti di fabbricazione; la garanzia è limitata alla sostituzione o riparazione dei prodotti riconosciuti difettosi presso la sede della Società, con esclusione di qualsiasi diritto al risarcimento dei danni. La suddetta garanzia non si applica a prodotti che presentano normale usura, segni di manomissione o di uso improprio. Le spese di trasporto dei prodotti da sostituire o riparare e dei prodotti sostituiti o riparati sono a carico dell'Acquirente. In presenza dei presupposti di cui al comma precedente Beta sostituirà o riparerà gratuitamente il Prodotto riscontrato difettoso all'origine se reso franco sede della Società con relativo documento di trasporto sul quale dovranno essere indicati, oltre alla dicitura merce difettosa, gli estremi della fattura emessa all'atto della vendita.

Salvo il caso di dolo o colpa grave, la Società sarà tenuta, in caso di vizi o mancanza di qualità dei prodotti, unicamente alla riparazione o sostituzione dei prodotti difettosi. È inteso che la suddetta garanzia (consistente nell'obbligo di riparare o sostituire i prodotti) comprende e sostituisce ogni garanzia o responsabilità della Società (sia contrattuale che extracontrattuale) comunque originata dai prodotti forniti (ad es. risarcimento del danno, mancato guadagno ecc.).

RECLAMI

Il Cliente deve denunciare gli eventuali vizi e difetti dei prodotti forniti o l'eventuale mancata o difforme fornitura di tutto o parte dell'Ordine d'Acquisto, a pena di decadenza, entro il termine di 8 (otto) giorni da calcolarsi rispettivamente dalla data di consegna dei prodotti (vizi apparenti) e/o da quella della scoperta dei vizi o difetti (vizi occulti). Nel caso di vizi palesi la denuncia dovrà essere fatta per iscritto a mezzo di lettera raccomandata a.r..

Eventuali contestazioni non danno diritto al Cliente di sospendere o comunque ritardare i pagamenti dei prodotti oggetto di contestazione né, tanto meno, di altre forniture.

La garanzia non opera nel caso in cui l'Acquirente abbia eseguito o fatto eseguire interventi da parte di terzi sui prodotti, senza il preventivo consenso scritto di Beta. La merce difettosa, qualora non presenti inconvenienti dovuti a normale logorio, errato uso o evidente manomissione, verrà riparata o sostituita gratuitamente solo se restituita in porto franco presso la sede della Società, indicando nel documento di accompagnamento la causale e gli estremi della fattura relativa.

RESI

Eventuali resi di merce vengono accettati solo se preventivamente concordati e autorizzati per iscritto; contrariamente saranno rispediti al mittente con trasporto a proprio carico.

In ogni caso nel documento di accompagnamento devono essere indicati la causale del reso ed il numero di autorizzazione ricevuto.

Tali resi dovranno essere inviati presso la sede della Società in Via Volta n. 18 - 20845 SOVICO (MB).

FORO COMPETENTE

Le presenti Condizioni Generali di Vendita sono regolate dalle leggi della Repubblica Italiana. Per tutto quanto non espressamente regolato dalle presenti condizioni, sarà applicata la normativa del codice civile.

Per qualsiasi controversia derivante dal contratto di vendita disciplinati dalle presenti Condizioni Generali di Vendita o ad esso collegata sarà esclusivamente competente il Foro di Monza, fatte comunque salve diverse inderogabili norme di legge.

CONDIZIONI GENERALI DI VENDITA

Gli ordini trasmessi per l'acquisto di prodotti Robur dalla Beta Utensili SpA (d'ora in poi "Beta" o "Società") devono essere inviati alla nostra sede produttiva di Sulmona e comportano l'accettazione automatica e senza riserve delle presenti Condizioni Generali di Vendita che costituiscono parte integrante del contratto di vendita. Eventuali deroghe alle stesse saranno efficaci solo se concordate per iscritto dalle parti e limitatamente alle vendite cui si riferiscono.

PRODOTTI

I pesi, le dimensioni, i prezzi, i colori e gli altri dati figuranti nei cataloghi, prospetti, circolari, od altri documenti illustrativi della Società, hanno carattere di indicazioni approssimative.

Beta si riserva di variare in qualsiasi momento, senza preavviso, i dati tecnici o costruttivi dei suoi prodotti.

ORDINI

Le presenti Condizioni Generali di Vendita si intendono approvate dall'acquirente con la trasmissione dell'ordine, ordine che viene ricevuto dalla Società sempre con la clausola "salvo approvazione della casa". Beta può accettare l'ordine mediante spedizione della merce, conformemente all'art. 1327 c.c..

Nell'ordine deve essere specificato il codice dell'articolo e la relative quantità.

Le quantità minime sono indicate nel listino per ciascun articolo. Ordini non corrispondenti ad esse, od ai loro multipli, verranno automaticamente adeguati senza previa autorizzazione al Cliente.

RIMANENZE

La Società si riserva la facoltà di evadere l'ordine tutto o in parte ovvero in diverse riprese. Nell'eventualità di ordini non completamente evasi Beta invierà tramite e-mail una distinta riepilogativa delle rimanenze di detti ordini che, salvo espressa richiesta contraria, saranno incluse nella o nelle spedizioni successive. Previa specifica richiesta del Cliente tali informazioni verranno trasmesse via fax.

TERMINI DI CONSEGNA

Eventuali termini di consegna, comunque e dovunque previsti, avranno valore puramente indicativo. La Società declina ogni responsabilità per il caso di ritardo nella consegna che non derivi da suo dolo o colpa grave. Il mancato rispetto dei termini di consegna, purché contenuto in un ragionevole lasso di tempo, non dà diritto al Cliente di richiedere un risarcimento, né di annullare gli Ordini, a meno che, avuto riguardo alla normale tollerabilità ed alla natura del contratto ed alla fornitura, la stessa non abbia più importanza per il Cliente. In questo caso l'onere probatorio sarà a carico del Cliente stesso.

Salvo il caso di dolo o colpa grave della Società, è espressamente escluso qualsiasi risarcimento del danno per mancata o ritardata consegna dei prodotti.

GESTIONE ORDINI, SPEDIZIONI E IMBALLI

Le spedizioni sono effettuate franco destino con addebito delle spese in fattura con mezzi di trasporto a scelta della Società.

L'imballo è gratuito quando non richiesto di tipo particolare.

Il trasferimento dei rischi relativi ai prodotti ha luogo al momento della loro consegna al Vettore: conseguentemente, i prodotti viaggiano a rischio e pericolo del destinatario anche in caso di spedizione porto franco.

L'Acquirente che sia già cliente abituale potrà utilizzare il **nostro servizio rapido** anche per quantità diverse dall'unità di confezionamento previste. Il costo del servizio verrà addebitato nella misura forfetaria del 6% in sede di fatturazione e le spese di spedizione saranno a carico del Cliente.

PREZZI

L'indicazione di prezzo contenuta in cataloghi, listini, ecc. è meramente indicativa e potrà quindi subire variazioni senza necessità di preventiva informazione. Salvo diverso accordo tra le parti, la merce sarà fatturata ai prezzi in vigore al momento della spedizione.

I prezzi si intendono al netto di iva, di eventuali imposte o tasse, nonché di tributi, diritti ed oneri fiscali o di qualsiasi specie eventualmente gravanti sul contratto che restano a carico esclusivo del Cliente.

PAGAMENTI

Il pagamento deve essere corrisposto direttamente presso la sede della Società in Via Volta n. 18, 20845 Sovico (MB) ovvero alla persona munita di

autorizzazione scritta con le modalità e nei termini indicati nella fattura.

Sconti per pagamenti a breve termine vanno calcolati sull'importo netto della merce, escluso imballo, spese postali o di trasporto e iva. Trascorsi 15 giorni dalla data della fattura o dal periodo concordato, si intende revocato il beneficio dello sconto condizionato e pertanto la rimessa andrà effettuata per il totale della fattura.

Il ritardato pagamento rispetto alla data pattuita darà luogo all'addebito degli interessi di mora di cui all'art. 5 del D.Lgs. 231/02 e produrrà la perdita per il Cliente del beneficio del termine ai sensi dell'art. 1186 cod. civ., rendendo immediatamente esigibili eventuali somme non ancora scadute.

Il Cliente non è autorizzato ad effettuare alcuna deduzione dal prezzo pattuito (ad es. in caso di pretesi difetti dei prodotti), se non previo accordo scritto con la Società.

GARANZIA

I prodotti venduti da Beta sono garantiti in relazione a vizi o difetti di fabbricazione; la garanzia è limitata alla sostituzione o riparazione dei prodotti riconosciuti difettosi presso la sede della Società, con esclusione di qualsiasi diritto al risarcimento dei danni. La suddetta garanzia non si applica a prodotti che presentano normale usura, segni di manomissione o di uso improprio. Le spese di trasporto dei prodotti da sostituire o riparare e dei prodotti sostituiti o riparati sono a carico dell'Acquirente. In presenza dei presupposti di cui al comma precedente Beta sostituirà o riparerà gratuitamente il Prodotto riscontrato difettoso all'origine se reso franco sede della Società con relativo documento di trasporto sul quale dovranno essere indicati, oltre alla dicitura merce difettosa, gli estremi della fattura emessa all'atto della vendita.

Salvo il caso di dolo o colpa grave, la Società sarà tenuta, in caso di vizi o mancanza di qualità dei prodotti, unicamente alla riparazione o sostituzione dei prodotti difettosi. È inteso che la suddetta garanzia (consistente nell'obbligo di riparare o sostituire i prodotti) comprende e sostituisce ogni garanzia o responsabilità della Società (sia contrattuale che extracontrattuale) comunque originata dai prodotti forniti (ad es. risarcimento del danno, mancato guadagno ecc.).

RECLAMI

Il Cliente deve denunciare gli eventuali vizi e difetti dei prodotti forniti o l'eventuale mancata o difforme fornitura di tutto o parte dell'Ordine d'Acquisto, a pena di decadenza, entro il termine di 8 (otto) giorni da calcolarsi rispettivamente dalla data di consegna dei prodotti (vizi apparenti) e/o da quella della scoperta dei vizi o difetti (vizi occulti). Nel caso di vizi palesi la denuncia dovrà essere fatta per iscritto a mezzo di lettera raccomandata a.r..

Eventuali contestazioni non danno diritto al Cliente di sospendere o comunque ritardare i pagamenti dei prodotti oggetto di contestazione né, tanto meno, di altre forniture.

La garanzia non opera nel caso in cui l'Acquirente abbia eseguito o fatto eseguire interventi da parte di terzi sui prodotti, senza il preventivo consenso scritto di Beta. La merce difettosa, qualora non presenti inconvenienti dovuti a normale logorio, errato uso o evidente manomissione, verrà riparata o sostituita gratuitamente solo se restituita in porto franco presso la sede della Società, indicando nel documento di accompagnamento la causale e gli estremi della fattura relativa.

RESI

Eventuali resi di merce vengono accettati solo se preventivamente concordati e autorizzati per iscritto; contrariamente saranno rispediti al mittente con trasporto a proprio carico.

In ogni caso nel documento di accompagnamento devono essere indicati la causale del reso ed il numero di autorizzazione ricevuto.

Tali resi dovranno essere inviati presso la sede produttiva della Società in Zona Industriale - Contrada S. Nicola - 67039 SULMONA (AQ).

FORO COMPETENTE

Le presenti Condizioni Generali di Vendita sono regolate dalle leggi della Repubblica Italiana. Per tutto quanto non espressamente regolato dalle presenti condizioni, sarà applicata la normativa del codice civile.

Per qualsiasi controversia derivante dal contratto di vendita disciplinati dalle presenti Condizioni Generali di Vendita o ad esso collegata sarà esclusivamente competente il Foro di Monza, fatte comunque salve diverse inderogabili norme di legge.



VALLE D'AOSTA

PIEMONTE: Torino, Novara, Vercelli, Biella, Verbano-Cusio-Ossola
MARCO MARTORANA
 Cell. 392.4135190
 mezzarana@libero.it
 marco.martorana1969@hotmail.it

LIGURIA

PIEMONTE: Alessandria, Asti, Cuneo
ALESSANDRO DE SANCTIS
 Cell. 348.3008699
 Fax 019.90085
 alessanc@libero.it

LOMBARDIA NORD OVEST:

provincia Nord Milano, Monza, Como, Sondrio, Varese
ALBERTO RADAELLI
 Tel. 039.2010558
 Cell. 368.946851
 Fax 039.2015252
 roal2003@tiscali.it

LOMBARDIA SUD OVEST:

Lodi, Pavia, Milano città, provincia Sud Milano
LUIGI FUMAGALLI SAS
 Cell. 335.214487
 Fax 039.570186
 lfrappresentanze@tiscalinet.it

LOMBARDIA NORD EST:

Provincia Est Milano, Bergamo, Lecco
AVIDANO SIMEONI
 Cell. 335.5296941
 Fax 02.45500738
 ufficio@avidanosimeoni.it

LOMBARDIA SUD EST:

Brescia, Mantova, Cremona
VENETO: Verona
MARCO VESENTINI
 Cell. 346.0831683
 Fax 0376.809741
 marcovesentini@tiscali.it

TRENTINO ALTO ADIGE

VENETO: Vicenza
TARGA SERGIO & C. SAS
 Cell. 348.4112065
 Fax 0461.530550
 targa_s70@yahoo.it

VENETO:

Padova, Rovigo, Belluno, Treviso, Venezia
NICOLA MION
 Cell. 335.8427204
 Fax 0422.452468
 n.mion@virgilio.it

FRIULI VENEZIA GIULIA

MAURO BARBOTTI & C. SAS
 Cell. 338.4070716
 Fax 040.830630
 maurobarbotticas@gmail.com

EMILIA ROMAGNA:

Modena, Parma, Reggio Emilia, Piacenza
MARCO PERVILLI
 Cell. 335.7013227
 m.pervilli@gmail.com

EMILIA ROMAGNA:

Bologna, Ferrara, Ravenna, Forlì-Cesena, Rimini
RIEM - MARCO MALAGÜTI
 Tel. 051.6257778
 Cell. 335.5488324
 Fax 051/6257627
 info@nuovariem.com

TOSCANA:

Firenze, Pistoia, Prato, Livorno, Pisa, Lucca, Massa Carrara
STEFANO CAMERINI
 Cell. 347.5084765
 Fax 055.289350
 camerini.stefano@tiscali.it

TOSCANA:

Grosseto, Siena, Arezzo
UMBRIA
GABBI PAOLO
 Cell. 348.7105920
 Fax 0575.351998
 gabbi@tiscalinet.it

MARCHE - REP. SAN MARINO

ALEX CAPPANERA
 Cell. 339.4718269
 Fax 0731.205528
 alex@cappanera.it

ABRUZZO - MOLISE - Beta

MAURO BISOGNINI
 Tel. 071.2862055
 Fax 071.2863155
 info@maurobisognini.it
 www.maurobisognini.it

ABRUZZO - MOLISE - Robur

FRANCESCO BIBONE
 Cell. 328/2827915
 Fax 085.2058663
 fbibone@yahoo.it

LAZIO

DANIELE MARINELLI
 Tel. 06.8177774 - 06.8183359
 Cell. 335.5394617
 Fax 06.39725066
 marinelliagenzia@tiscali.it

CAMPANIA:

Benevento, Caserta, Napoli Nord
ANTONINO SCOGNAMIGLIO
 Cell. 335.5281534
 Fax 081.2140299
 antonino.scognamiglio@fastwebnet.it

CAMPANIA:

Avellino, Salerno, Napoli Sud
BASILICATA: Potenza
ESPOSITO RAPPRESENTANZE
 Cell. 335.6212740
 Fax 081.2140299
 alfredo-esposito@fastwebnet.it

PUGLIA - Beta

BASILICATA: Matera
GIOVANNI PEPE
 Cell. 393.3334452
 Tel. / Fax 080.5492515
 giovanni.pepe@hotmail.com

PUGLIA - Robur

BASILICATA: Matera
FRANCESCO PEPE
 Cell. 329.7955353
 Tel. / Fax 080-5492515
 francesco.pepe@hotmail.com

CALABRIA

DOMENICO ARAGONA
 Cell. 337.872220 (Domenico)
 Cell. 339.8740220 (Francesco)
 Fax 0984.465320
 aragonadomenico@virgilio.it

SICILIA EST:

Messina, Catania
SALVATORE TUDISCO
 Cell. 335.8064374
 Fax 095.2937744
 info@agenziatudisco.it

SICILIA EST:

Siracusa, Ragusa, Enna
RITA ITALIA
 Cell. 338.6365091
 Fax 0931.870400
 ritaitalia@gmail.com

SICILIA OVEST:

Palermo, Trapani, Caltanissetta, Agrigento
DANIELE MARGIOTTA
 Cell. 349.3219474
 Fax 091.307825
 danielemargiotta@tiscali.it

SARDEGNA:

Oristano, Cagliari, Carbonia-Iglesias, Medio Campidano
PI.CO - LUCIANO COMPARETTI
 Cell. 349.4977448
 Fax 070.513150
 pico.comparetti@tiscali.it

SARDEGNA:

Sassari, Nuoro, Ogliastra, Olbia-Tempio
PI.CO - SALVATORE PILLA
 Cell. 349.4977449
 Fax 079.501493
 pico.pilla@tiscali.it



Beta

IL NOSTRO SERVIZIO RAPIDO



1. Possibilità di acquistare qualsiasi articolo a listino senza obbligo di quantità
2. Consegna in tutta Italia nelle 24 ore per ordini pervenuti entro le ore 11.00
(48 ore per Basilicata, Calabria, Sardegna, Sicilia)

- A. Gli ordini devono essere inviati unicamente tramite fax al numero 800.978.377 o via e-mail a: servizio.rapido@beta-tools.it
- B. Il costo del servizio verrà addebitato nella misura forfettaria del 6% in sede di fatturazione
- C. Le spese di spedizione sono a carico del cliente

È possibile effettuare il ritiro della merce con mezzi propri ai seguenti indirizzi:

- 📍 Magazzino sede Beta – via Volta 18, 20845 Sovico (MB)
- 📍 Polo logistico Züst Ambrosetti – Via Toffetti 104, 20139 Milano
- 📍 Centro Logistico di Marzano Geodis – Strada Provinciale 128, km 2, 27010 Marzano (PV)



Beta RESO 55

50 years in motorsports



Beta

Robur BetaWORK Beta ^{Beta}SHOP *shop*



Simone Corsi
Moto2 World Championship

Partnership 2016

998064841
8 014230 830605

