

CATALOGUE | CATALOGO

 2016



H.P. WATER CLEANERS › VACUUM CLEANERS
IDROPULTRICI › ASPIRATORI

clean

CLEANING DIVISION



BLUE SERIES COMMERCIAL

KR 1100 / X-STAR	6
KL	8
KS	10
KT	12
KA	14

BLUE SERIES STATIC

STATIC 1700-1900	16
K 250 STATIC	18

BLUE SERIES PROFESSIONAL

K 250	20
K PREMIUM	22

K STEEL

ETM	24
K 803 TS › K 805 TS › K 807 TS › K 809 TS	26
K 891 TS › K 991 TS	28
K 809 ECO › K 801 ECO › K 901 ECO	30
K 1001 TS › K 1251 TS › K 1501 TS	32
K XTREME	34

X-SPECIAL COLD WATER

FDX 2	36
FDX PRO	38
FDX 4	40
FDX XTREME	42
FDX WB	44
PTO	46

X-SPECIAL HOT WATER

FDX HOT CUBE	48
HOT BOX	50

RED SERIES COMMERCIAL

TRAPPER 2	52
SCOUT	54

RED SERIES PROFESSIONAL

KP	56
KP PRO	58
KM CLASSIC	60
KM EXTRA	62
KE PREMIUM PLUS	64
KF CLASSIC	66
KF EXTRA	68

VACUUM CLEANERS › ASPIRATORI

VACUUM CLEANERS › ASPIRATORI	70
------------------------------	----

NEBULIZERS › NEBULIZZATORI

NEBULIZERS › NEBULIZZATORI	76
----------------------------	----

DETERGENTS › DETERGENTI

DETERGENTS › DETERGENTI	78
-------------------------	----

ACCESSORIES › ACCESSORI

BLUE SERIES COMMERCIAL - STATIC	80
BLUE SERIES PROFESSIONAL - K STEEL	86
X-SPECIAL COLD - HOT WATER	98
RED SERIES COMMERCIAL	108
RED SERIES PROFESSIONAL	110
VACUUM CLEANERS ACCESSORIES › ACESSORI ASPIRATORI	116
NOZZLES › UGELLI	118
CHARTS › TABELLE	120

LEGEND › LEGENDA



Cold water H.P. Cleaners - Idropulitrici ad acqua fredda



Hot water H.P. Cleaners - Idropulitrici ad acqua calda



bar - MPa = Max pressure - Pressione max



l/h = Max flow rate - Portata max



kW = Absorbed power - Potenza assorbita



HP / kW = Electric Motor power - Potenza Motore elettrico



Electrical power supply - Alimentazione da rete elettrica



HP = Engine Motor - Motore a scoppio



Fuel power supply - Alimentazione a carburante



°C = Outlet max water temperature - Temperatura max uscita acqua



lt = Diesel tank - Serbatoio gasolio



kg/h = Fuel consumption - Consumo combustibile



lt = Detergent tank - Serbatoio detergente



kg = Weight - Peso



cm = Dimensions - Dimensioni



RPM motor - Giri motore



RPM pump - Giri pompa

TotalStop

Device that automatically stops the motor when the gun is closed.
Dispositivo che consente lo spegnimento automatico del motore alla chiusura della pistola.

EASY-START

Device that guarantees starting of the motor under any and all connection conditions, even if there is a drop in mains voltage.
Dispositivo che garantisce la partenza del motore in ogni condizione di allacciamento, anche in presenza di cali di tensione della rete elettrica.

PREMIUM



EXCLUSIVE NO-OIL-LEAK SYSTEM
in the crankcase minimising wear of the piston oil seal (PATENTED)

ESCLUSIVO SISTEMA DI TENUTA TRA CARTER E TESTATA

che impedisce l'ingresso di polvere e sporizia nella zona di scorrimento pistoni pur permettendo la fuoriuscita dell'acqua (BREVETTATO)



EXCLUSIVE PACKING SYSTEM
New self lubricating double packing design with special bunatexile seals and bronze rings for an exceptional packing life.

ESCLUSIVO SISTEMA DI TENUTE ACQUA AUTOLUBRIFICATO con doppio pacco di guarnizioni in gomma tela rinforzate con anelli in teflon/bronzo per una eccezionale durata delle guarnizioni



EXCLUSIVE SEALING SYSTEM BETWEEN CRANKCASE AND PUMP HEAD that prevents dust and dirt getting inside where the pistons work but letting water out (PATENTED)

ESCLUSIVO SISTEMA DI TENUTA OLIO nel carter che minimizza l'usura del paraolio pistoni (BREVETTATO)

BA10 BACKFLOW PREVENTER



BA 10 › BackFlow Preventer is a special safety device that prevents water flowing back to the source, isolating the drinking water supply network from the circuit that supplies water to the cleaner.

BA 10 › BackFlow Preventer è uno speciale dispositivo di sicurezza che evita il riflusso d'acqua verso la fonte, isolando la rete idrica potabile dal circuito di alimentazione dell'idropulitrice.



**MANDATORY BY LAW
EN 60335 - 2 - 79 : 2010**

According to the EU directives currently in force, the water that passes through a high-pressure cleaner is no longer considered fit for drinking. This is why it cannot be connected directly to the drinking water supply network unless a BA 10 Back Flow Preventer disconnecter has been installed.

**OBBLIGATORIO PER LEGGE
EN 60335 - 2 - 79 : 2010**

Secondo le vigenti direttive comunitarie, l'acqua che attraversa un'idropulitrice non è più considerata potabile. Per tale motivo un'idropulitrice non può essere collegata direttamente alla rete d'acqua potabile senza aver prima installato il disconnettore BA 10 Back Flow Preventer.



The BA10 › BackFlow Preventer is easily fitted directly on the water tap.

BA10 › BackFlow Preventer si monta con estrema semplicità direttamente al rubinetto della rete idrica.



When the tap is turned on the flow of water hermetically closes the BA10 › BackFlow Preventer discharge valve that acts just like part of a straight hose.

All'apertura del rubinetto, il flusso d'acqua chiude ermeticamente la valvola di scarico del BA10 › BackFlow Preventer che si comporta come una porzione di tubo rettilineo.

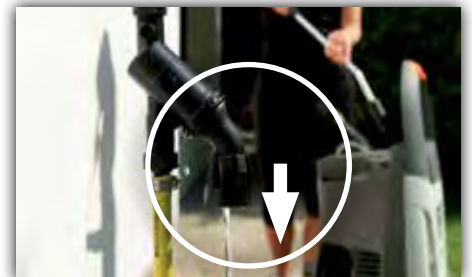

The BA10 › BackFlow Preventer starts working when network pressure drops, cutting the drinking water supply network off from the circuit supplying the high-pressure cleaner, discharging the water externally.

BA10 › BackFlow Preventer entra in funzione quando la pressione di rete cala, isolando la rete idrica potabile dal circuito di alimentazione dell'idropulitrice, scaricando all'esterno l'acqua.



Horizontal fitting
Installazione orizzontale



Vertical fitting
Installazione verticale



Do not connect it directly to the high-pressure cleaner
Non collegare direttamente all'idropulitrice



KR 1100 / X-STAR



MTP KLR
(X-STAR)



KR1100 - GENERAL FEATURES

- Easy handling thanks to the 115 mm diameter wheels
- Quick water intake fitting
- Vertical electrical pump with pump at the bottom and an all-metal construction without any plastic used for the structural components
- TotalStop device
- Universal type motor
- Motor thermal protection

KR1100 - CARATTERISTICHE GENERALI

- Facilità di movimento grazie alle ruote di diametro 115 mm
- Attacco rapido aspirazione acqua
- Elettropompa disposta in verticale con pompa in basso, costruzione interamente in metallo, senza materiale plastico nei componenti strutturali
- Dispositivo TotalStop
- Motore di tipo universale
- Protezione termica del motore
- Uso domestico



X-STAR - GENERAL FEATURES

- Vertical structure, designed for maximum ergonomics and ease of use
- Comet electrical pump with pump at the bottom and an all-metal construction without any plastic used for the structural components
- EASY-START device
- TotalStop device
- Motor thermal protection

X-STAR - CARATTERISTICHE GENERALI

- Struttura a sviluppo verticale concepita per la massima ergonomia e praticità d'uso
- Elettropompa Comet con pompa in basso e costruzione interamente in metallo, senza materiale plastico nei componenti strutturali
- Dispositivo EASY-START
- Dispositivo TotalStop
- Protezione termica del motore
- Uso domestico

- Ergonomic handle for easy handling
- *Comoda maniglia di presa ergonomica per facilitare la movimentazione dell'idropulitrice*

- Practical positioning of the power cable and delivery hose.
- *Pratico posizionamento cavo elettrico e tubo di mandata.*

- Quickfit coupling for connecting to the water mains
- *Raccordo con attacco rapido per il collegamento alla rete idrica*

- Easy-to-fit accessories
- *Pratici alloggiamenti per gli accessori*



CODE CODICE	MODELS MODELLI	MOTORPUMP MOTOPIOMPA									
			Ph	V	Hz	bar	MPa	l/h	kW	kg	(L x W x H) cm
9054 0001	KR 1100	-	1	230	50	120	12	360	1,6	10	82 x 28 x 26
9048 0001	X-STAR Classic	KLR	1	230	50	120	12	360	1,6	11	44 x 21 x 21
9048 0501	X-STAR Extra	KLR	1	230	50	120	12	360	1,6	11	44 x 21 x 21

STANDARD ACCESSORIES › DOTAZIONE STANDARD

KR1100	X-STAR CLASSIC	X-STAR EXTRA
 Gun with protection <i>Kit pistola con protezione</i>	 Gun with protection <i>Kit pistola con protezione</i>	 Gun with protection <i>Kit pistola con protezione</i>
 Lance with adjustable nozzle <i>Lancia con ugello regolabile</i>	 Lance without nozzle head (securfix) <i>Lancia senza testina ugello (securfix)</i>	 Lance without nozzle head (securfix) <i>Lancia senza testina ugello (securfix)</i>
 Lance with rotating nozzle <i>Lancia con ugello rotante</i>	 Adjustable nozzle head (securfix) <i>Testina ugello regolabile (securfix)</i>	 Adjustable nozzle head (securfix) <i>Testina ugello regolabile (securfix)</i>
 Foam lance <i>Lancia schiumogena</i>		 Rotating nozzle head (securfix) <i>Testina ugello rotante (securfix)</i>
 5 m delivery hose kit <i>Kit tubo mandata 5 m</i>	 Foam lance <i>Lancia schiumogena</i>	 Foam lance <i>Lancia schiumogena</i>
 Suction coupler <i>Raccordo aspirazione</i>	 6 m delivery hose kit <i>Kit tubo mandata 6 m</i>	 6 m delivery hose kit <i>Kit tubo mandata 6 m</i>
 Water filter <i>Filtro acqua</i>		 Fixed brush <i>Idrospazzola fissa</i>



KL

1300 - 1400 - 1600 GOLD 1680 GOLD PLUS



MTP KLR



MTP KLR Gold



GENERAL FEATURES

- Vertical structure, designed for maximum ergonomics and ease of use
- Comet electrical pump with three axial pistons arranged vertically with pump at the bottom and an all-metal construction without any plastic used for the structural components
- Brass pump head for KL Gold only
- **EASY-START** device
- **TotalStop** device
- Motor thermal protection
- Quick water intake fitting

CARATTERISTICHE GENERALI

- *Struttura a sviluppo verticale concepita per la massima ergonomia e praticità d'uso*
- *Elettropompa Comet a tre pistoni assiali disposta in verticale con pompa in basso e costruzione interamente in metallo, senza materiale plastico nei componenti strutturali*
- *Testata pompa in ottone per KL Gold*
- **Dispositivo EASY-START**
- **Dispositivo TotalStop**
- **Protezione termica del motore**
- **Attacco rapido aspirazione acqua**
- **Uso domestico**

- Easy-to-fit accessories
- *Pratici alloggiamenti per gli accessori*

- Hose reel at the back
- *Avvolgitubo collocato nella parte posteriore*

- Easy to handle thanks to the big wheels (rubber coated on KL Gold models)
- *Facilità di movimento grazie alle ruote di grandi dimensioni (rivestite in gomma nei modelli KL Gold)*

- Additional handle for lifting
- *Maniglia supplementare per il sollevamento*



CODE CODICE	MODELS MODELLI	MOTORPUMP MOTOPOMPA									
			Ph	V	Hz	bar	MPa	l/h	kW	kg	(L x W x H) cm
9046 0066	KL 1300 Classic	KLR	1	230	50	130	13	360	1,7	12	82 x 30,8 x 31
9046 0003	KL 1400 Classic	KLR	1	230	50	140	14	410	2,0	12	82 x 30,8 x 31
9046 0065	KL 1600 Gold Classic	KLR	1	230	50	150	15	480	2,3	12	82 x 30,8 x 31
9046 0067	KL 1300 Extra	KLR	1	230	50	130	13	360	1,7	13	82 x 30,8 x 31
9046 0004	KL 1400 Extra	KLR	1	230	50	140	14	410	2,0	13	82 x 30,8 x 31
9046 0064	KL 1600 Gold Extra	KLR	1	230	50	150	15	480	2,3	13	82 x 30,8 x 31
9046 0500	KL 1680 Gold Plus	KLR	1	230	50	150	15	480	2,3	13	82 x 30,8 x 31

STANDARD ACCESSORIES › DOTAZIONE STANDARD

CLASSIC	EXTRA	PLUS
	Gun with protection <i>Pistola con protezione</i>	
Lance without nozzle head (securfix) <i>Lancia senza testina ugello (securfix)</i>		Lance with adjustable nozzle <i>Lancia con ugello regolabile</i>
		Lance with rotating nozzle <i>Lancia con ugello rotante</i>
Adjustable nozzle head (securfix) <i>Testina ugello regolabile (securfix)</i>		
	Rotating nozzle head (securfix) <i>Testina ugello rotante (securfix)</i>	
	Foam lance <i>Lancia schiumogena</i>	
6 m delivery hose kit <i>Kit tubo mandata 6 m</i>	8 m delivery hose kit <i>Kit tubo mandata 8 m</i>	8 m R1-1/4" delivery rubber hose kit <i>Kit tubo gomma mandata 8 m R1-1/4"</i>
	Fixed brush <i>Idrospazzola fissa</i>	



KS

1700 GOLD



MTP KSR



GENERAL FEATURES

- Comet electrical pump with three axial pistons arranged vertically with pump at the bottom and an all-metal construction without any plastic used for the structural components
- Equipped with a brass pump head and detergent suction straight from a 1.8 litre capacity tank
- **EASY-START** device
- **TotalStop** device
- Manually resettable amperometric protection
- Pressure gauge
- Water inlet quick coupling

CARATTERISTICHE GENERALI

- *Elettropompa Comet a tre pistoni assiali disposta in verticale con pompa in basso e costruzione interamente in metallo, senza materiale plastico nei componenti strutturali.*
- *Dotata di testata pompa in ottone e aspirazione del detergente diretta da serbatoio capacità 1,8 lt*
- **Dispositivo EASY-START**
- **Dispositivo TotalStop**
- **Protettore amperometrico a riarmo manuale**
- **Manometro pressione**
- **Attacco rapido aspirazione acqua**
- **Uso semiprofessionale**

- Ergonomic handle for easy handling
- Comoda maniglia di presa per facilitare la movimentazione dell'idropultrice



- Easy to handle up and down steps thanks to the big wheels
- Facilità di movimento su gradini grazie alle ruote di grandi dimensioni



- Hose reel with 10 m rubber high-pressure hose (for Extra models only)
- Avvolgitubo con tubo gomma alta pressione 10 m (solo per modelli Extra)



CODE CODICE	MODELS MODELLI	MOTORPUMP MOTOPOMPA										
			Ph	V	Hz	bar	MPa	l/h	kW	l	kg	(L x W x H) cm
9041 0002	KS 1700 Gold Classic	KSR	1	230	50	155	15,5	540	2,7	1,8	17	89 x 32 x 38
9041 0502	KS 1700 Gold Extra	KSR	1	230	50	155	15,5	540	2,7	1,8	19	89 x 32 x 38



STANDARD ACCESSORIES › DOTAZIONE STANDARD

CLASSIC	EXTRA
	GC 251 gun with protection <i>Pistola GC 251 con protezione</i>
	Bent lance, with adjustable nozzle <i>Lancia angolata, con ugello regolabile</i>
	Bent lance, with rotating nozzle <i>Lancia angolata, con ugello rotante</i>



KT



1750 GOLD - 1800 GOLD - 1900 GOLD



MTP KTR Gold



GENERAL FEATURES

- Hose reel (Extra only) located at the bottom of the high-pressure water cleaner guaranteeing exceptional stability also when in use
- Low-pressure detergent suction from the internal tank
- Detergent suction kit from an external tank (on request)
- Power cable storage rear compartment
- Comet electrical pump with three axial pistons arranged vertically with pump at the bottom and an all-metal construction without any plastic used for the structural components
- Pump with brass head on all models
- EASY-START device
- TotalStop device
- Motor thermal protection



CARATTERISTICHE GENERALI

- Avvolgitubo (solo Extra) collocato nella parte inferiore della idropulitrice con garanzia di eccezionale stabilità della macchina anche durante il lavoro
- Aspirazione detergente in bassa pressione dal serbatoio interno
- Kit aspirazione detergente da serbatoio esterno (su richiesta)
- Vano posteriore per collocare il cavo elettrico
- Elettropompa Comet a tre pistoni assiali disposta in verticale con pompa in basso e costruzione interamente in metallo, senza materiale plastico nei componenti strutturali
- Pompa con testata in ottone su tutti i modelli
- Dispositivo EASY-START
- Dispositivo TotalStop
- Protezione termica motore
- Uso semiprofessionale

- Easy handling thanks to the two big wheels (250 mm Ø)
- *Facilità di movimentazione grazie alle due ruote di grandi dimensioni (Ø 250 mm)*

- Handy lance and gun storage
- *Pratico alloggiamento della pistola della lancia*

- Hose reel (Extra models only)
- *Avvolgitubo (solo modelli Extra)*

- Additional handle for lifting the high-pressure cleaner
- *Maniglia supplementare per il sollevamento dell'idropultrice*



CODE CODICE	MODELS MODELLI	MOTORPUMP MOTOPIOMPA										
			Ph	V	Hz	bar	MPa	l/h	kW	l	kg	(L x W x H) cm
9053 0005	KT 1750 Gold Classic	KTR	1	230	50	150	15	510	2,4	1	22	40 x 41 x 91
9053 0001	KT 1800 Gold Classic	KTR	1	230	50	160	16	550	2,7	1	22	40 x 41 x 91
9053 0003	KT 1900 Gold Classic	KTR	1	230	50	160	16	600	2,9	1	22	40 x 41 x 91
9053 0006	KT 1750 Gold Extra	KTR	1	230	50	150	15	510	2,4	1	25	40 x 41 x 91
9053 0002	KT 1800 Gold Extra	KTR	1	230	50	160	16	550	2,7	1	25	40 x 41 x 91
9053 0004	KT 1900 Gold Extra	KTR	1	230	50	160	16	600	2,9	1	25	40 x 41 x 91



STANDARD ACCESSORIES › DOTAZIONE STANDARD

CLASSIC		EXTRA	
	GC 251 gun with protection <i>Pistola GC 251 con protezione</i>		Bent lance, with adjustable nozzle <i>Kit tubo lancia angolata, con ugello regolabile</i>
	8 m rubber delivery hose kit <i>Kit tubo gomma mandata 8 m</i>		Bent lance, with rotating nozzle <i>Lancia angolata, con ugello rotante</i>
			Fixed brush <i>Idrospazzola fissa</i>
			12 m rubber delivery hose kit (on Hose Reel) <i>Kit tubo gomma mandata 12 m (su Avvolgitubo)</i>



KA



2800 - 3000 - 3200 - 4000 - 5000



AXR / GXR



GENERAL FEATURES

- Compact size for storing and practical to use thanks to its vertical design
- Simple to transport horizontally in the car
- Comet AXR pump with brass head and ceramic pistons (on KA 2800 GXR pump with brass head and stainless steel pistons)
- Pressure gauge
- Built-in professional unloader valve
- **EASY-START** device on single-phase models
- **TotalStop** device
- Rotary switch
- Regulated low-pressure detergent suction
- Motor thermal protection



CARATTERISTICHE GENERALI

- *Ingombro ridotto nella messa a riposo e praticità d'uso in condizioni di lavoro grazie allo sviluppo verticale*
- *Semplicità di trasporto su auto in posizione orizzontale*
- *Pompa Comet AXR con testata in ottone e pistoni in ceramica (su KA 2800 pompa GXR con testata in ottone e pistoni in acciaio)*
- *Manometro pressione*
- *Valvola di regolazione professionale integrata*
- *Dispositivo **EASY-START** sui modelli monofase*
- *Dispositivo **TotalStop***
- *Interruttore rotativo*
- *Aspirazione detergente in bassa pressione con regolazione*
- *Protezione termica del motore*
- *Uso semiprofessionale gravoso*

- Adjustable detergent suction device from an external tank with filter
- *Dispositivo di aspirazione detergente da tanica esterna, regolabile con filtro*



- 3 lt detergent tank, easily removed
- *Serbatoio detergente 3 lt facilmente rimovibile*



- Comet AXR / GXR pump, 3 axial plungers and brass pump head
- *Pompa Comet AXR / GXR, 3 pistoni assiali e testata in ottone*



- 15 m hose reel. Practical handle and stop device (on Excel)
- *Avvolgitubo di 15 m. Comoda maniglia e dispositivo di fermo (su Excel)*



CODE CODICE	MODELS MODELLI	MOTORPUMP MOTOPOMPA												
			Ph	V	Hz	bar	MPa	l/h	HP	kW	kW	l	kg	(L x W x H) cm
9037 0147	KA 2800 M Classic	GXR	1	230	50	140	14	540	2,6	1,9	2,6	3,0	36	44 x 42 x 94
9037 0002	KA 3000 M Classic	AXR	1	230	50	130	13	720	3,0	2,2	2,9	3,0	36	44 x 42 x 94
9037 0001	KA 3200 M Classic	AXR	1	230	50	150	15	600	3,0	2,2	2,9	3,0	36	44 x 42 x 94
9037 0005	KA 5000 T Classic	AXR	3	400	50	200	20	720	5,0	3,7	4,3	3,0	36	44 x 42 x 94
9037 0148	KA 2800 M Excel	GXR	1	230	50	140	14	540	2,6	1,9	2,6	3,0	36	44 x 42 x 94
9037 0021	KA 3000 M Excel	AXR	1	230	50	130	13	720	3,0	2,2	2,9	3,0	36	44 x 42 x 94
9037 0012	KA 3200 M Excel	AXR	1	230	50	150	15	600	3,0	2,2	2,9	3,0	36	44 x 42 x 94
9037 0016	KA 4000 T Excel	AXR	3	400	50	170	17	720	4,3	3,2	3,8	3,0	36	44 x 42 x 94
9037 0019	KA 5000 T Excel	AXR	3	400	50	200	20	720	5,0	3,7	4,3	3,0	36	44 x 42 x 94



STANDARD ACCESSORIES › DOTAZIONE STANDARD

CLASSIC		EXCEL	
	GC 251 gun with protection <i>Pistola GC 251 con protezione</i>		
	Lance with adjustable jet, with nozzle (for the KA 2800 model only) <i>Lancia getto regolabile con ugello (solo per modello KA 2800)</i>		
	Bent lance with detergent head, without nozzle <i>Lancia angolata con testina detergente, senza ugello</i>		
	Fan shape nozzle 1/4" MEG connection <i>Ugello con getto a lama attacco 1/4" MEG</i>		
	8 m rubber delivery hose kit <i>Kit tubo gomma mandata 8 m</i>		15 m rubber delivery hose kit (on Hose Reel) <i>Kit tubo mandata 15 m (su Avvolgitubo)</i>



STATIC



1700 GOLD - 1900 GOLD



MTP KTR Gold



GENERAL FEATURES

- Sturdy structure with tubular frame for wall mounting
- Equipped with a quick wall coupling system with safety lock
- Handy support for housing all the accessories
- Standard hose reel with rubber delivery hose
- Water inlet with cartridge filter
- **Comet electrical pump with three axial pistons arranged horizontally with pump at the bottom and an all-metal construction without any plastic used for the structural components**
- **Pump with brass head on all models**
- **EASY-START** device
- **TotalStop** device
- Motor thermal protection



CARATTERISTICHE GENERALI

- **Robusta struttura per applicazione a parete con telaio tubolare**
- **Equipaggiata con sistema di aggancio rapido a muro, con blocco di sicurezza**
- **Pratico supporto per alloggiare tutti gli accessori**
- **Avvolgitubo di serie con tubo mandata in gomma**
- **Ingresso acqua con filtro a cartuccia**
- **Elettropompa Comet a tre pistoni assiali disposta in orizzontale con pompa in basso e costruzione interamente in metallo, senza materiale plastico nei componenti strutturali**
- **Pompa con testata in ottone su tutti i modelli**
- **Dispositivo EASY-START**
- **Dispositivo TotalStop**
- **Protezione Termica del motore**
- **Usa semiprofessionale**

DUAL USE › DOPPIO USO

- Permanently fixed on the wall – always ready to use
- *Fissaggio statico a parete sempre pronta all'uso*
- Easily removable
- *Facilmente removibile*
- Easy to move to wherever else wanted
- *Facilmente trasportabile in altri posti di utilizzo*



CODE CODICE	MODELS MODELLI	MOTORPUMP MOTOPOMPA									
			Ph	V	Hz	bar	MPa	l/h	kW	kg	(L x W x H) cm
9052 0001	STATIC 1700 Classic Gold	KTR	1	230	50	150	15	510	2,4	20	50 x 26 x 60
9052 0008	STATIC 1900 Classic Gold	KTR	1	230	50	160	16	600	2,9	21	50 x 26 x 60
9052 0002	STATIC 1700 Extra Gold	KTR	1	230	50	150	15	510	2,4	22	50 x 26 x 60
9052 0015	STATIC 1700 Extra Gold with blue food-industry hose / con tubo blu anti-macchia	KTR	1	230	50	150	15	510	2,4	22	50 x 26 x 60
9052 0009	STATIC 1900 Extra Gold	KTR	1	230	50	160	16	600	2,9	23	50 x 26 x 60

- Brass pump head that withstands pressure and is corrosion resistant
- *Pompa con testata in ottone resistente alla pressione ed alla corrosione*
- Hose reel with 10 or 20 meter high pressure hose
- *Avvolgitubo con 10 o 20 metri di tubo ad alta pressione*
- Hose cleaning guide kit (optional)
- *Kit guida - pulisci tubo (optional)*
- Accessory rack supplied with the high-pressure cleaner
- *Supporto per gli accessori in dotazione all'idropulitrice*



STANDARD ACCESSORIES › DOTAZIONE STANDARD



GC 251 gun with protection
Pistola GC 251 con protezione



Bent lance, with adjustable nozzle
Lancia angolata, con ugello regolabile



Bent lance, with rotating nozzle
(for Extra models only)
Lancia angolata con ugello rotante (solo per modelli Extra)



Rack for accessory
Supporto accessori



Rotating brush
(for Extra models only)
Idrospazzola rotante (solo per modelli Extra)



Hose reel with rubber high-pressure hose
10m *(Classic models only)*
20m *(Extra models only)*
Avvolgitubo con tubo gomma alta pressione
10m *(solo modello Classic)*
20m *(solo modello Extra)*



Foam lance 1l
Lancia schiumogena 1l



K 250 STATIC



LW-K



GENERAL FEATURES

- Wall fixing or stationary use configuration
- Sturdy stainless steel casing
- Easy maintenance by simply removing the casing
- Low-pressure detergent suction
- Pressure gauge
- 4-pole motor (1400 rpm) well oversized and protected with paint
- Built-in professional unloader valve
- **TotalStop**
- Self-priming pumps with **EASY-START** device on single-phase models
- Rotary switch
- Motor thermal protection



CARATTERISTICHE GENERALI

- **Configurazione per fissaggio a muro o per utilizzo stazionario**
- Robuste carenature in acciaio inossidabile
- Facile manutenzione con la semplice rimozione della carenatura
- Aspirazione detergente in bassa pressione
- Manometro di pressione
- **Motore a 4 poli (1400 giri/min) ampiamente sovradimensionato e protetto da verniciatura**
- Valvola di regolazione professionale integrata
- **TotalStop**
- Pompe autoadescanti con dispositivo **EASY-START** per modello monofase
- Interruttore rotativo
- Protezione termica motore
- Uso professionale

ON THE WALL › A PARETE

Dual use
Doppio uso

ON THE FLOOR › A TERRA



CODE CODICE	MODELS MODELLI	PUMP POMPA											
			Ph	V	Hz	bar	MPa	l/h	HP	kW	kW	kg	(L x W x H) cm
9057 2001	K 250 Static 10/150 M	LW-K	1	230	50	150	15	600	3,0	2,2	2,9	40	55 x 35 x 35
9057 2003	K 250 Static 12/130 M	LW-K	1	230	50	130	13	720	3,0	2,2	2,9	40	55 x 35 x 35
9057 2002	K 250 Static 15/170 T	LW-K	3	400	50	170	17	900	5,5	4,0	5,0	40	55 x 35 x 35

STANDARD ACCESSORIES › DOTAZIONE STANDARD

	GH 301 gun with swivel Pistola GH 301 con swivel		Fan shape nozzle, 1/4" MEG connection Ugello con getto a lama attacco 1/4" MEG
	Bent lance with detergent head, without nozzle Lancia angolata con testina detergente, senza ugello		10 m rubber delivery hose kit with quick coupler M22x1,5 Kit tubo gomma mandata 10m, con attacco rapido M22x1,5
		Ejector kit Kit eiettore	



K 250



LW-K

1 CAN BE USED VERTICALLY
UTILIZZABILE IN VERTICALE

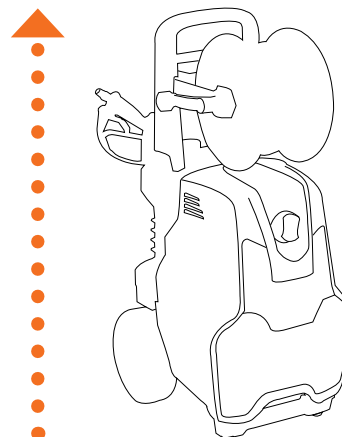

2 CAN BE USED HORIZONTALLY
UTILIZZABILE IN ORIZZONTALE

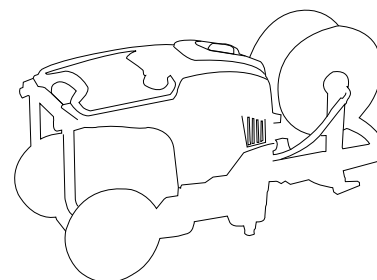

GENERAL FEATURES

- Sturdy injection-moulded plastic casing
- Handy lance and gun storage
- Handle with supports for the power cable and delivery hose
- **Easy maintenance by simply removing the front casing**
- Big wheels (220 mm Ø) for easy movement up and down steps and over uneven ground
- Removable detergent tank with level visible from the outside
- Detergent adjustment with filter
- Regulated low-pressure detergent suction
- Pressure gauge
- 4-pole motor (1400 rpm) well oversized and protected with paint
- Built-in professional unloader valve
- **TotalStop**
- Self-priming pumps with **EASY-START** device on single-phase models
- Rotary switch
- Motor thermal protection

CARATTERISTICHE GENERALI

- **Robuste carenature in materiale plastico stampato ad iniezione**
- **Pratico alloggiamento della pistola e della lancia**
- **Manico con supporti di cavo alimentazione e tubo mandata**
- **Facilità di manutenzione con la semplice rimozione della carenatura frontale**
- **Ruote di grandi dimensioni (Ø220mm) per una facile movimentazione su gradini e terreni accidentati**
- **Serbatoio detergente estraibile con livello visibile esternamente**
- **Regolazione detergente con filtro**
- **Aspirazione detergente in bassa pressione con regolazione**
- **Manometro di pressione**
- **Motore a 4 poli (1400 giri/min) ampiamente sovradimensionato e protetto da verniciatura**
- **Valvola di regolazione professionale integrata**
- **TotalStop**
- **Pompe autoadescanti dispositivo EASY-START modelli monof.**
- **Interruttore rotativo**
- **Protezione termica motore**
- **Uso professionale**

- COMET LW-K type pump with 3 integral ceramic pistons. Oil sight glass. Brass pump heads
- Pompa COMET tipo LW-K 3 pistoni in ceramica integrale. Visore livello olio. Testate in ottone

- Removable detergent tank with externally visible level
- Serbatoio detergente estraibile con livello visibile esternamente

- Hose reel 15/20 m (for Extra models only)
- Avvolgitubo 15/20 m (solo per modelli Extra)

- K 250 Classic



CODE CODICE	MODELS MODELLI	PUMP POMPA	Electrical			Pressure		Flow	Power		Consumption	Weight	Dimensions	
			Ph	V	Hz	bar	MPa		HP	kW				kW
9057 0002	K 250 10/150 M Classic	LW-K	1	230	50	150	15	600	3,0	2,2	2,9	3,5	40	54 x 44 x 68
9057 0004	K 250 12/130 M Classic	LW-K	1	230	50	130	13	720	3,0	2,2	2,9	3,5	40	54 x 44 x 68
9057 0006	K 250 11/160 M Classic *	LW-K	1	230	50	160	16	660	3,5	2,6	3,3	3,5	40	54 x 44 x 68
9057 0008	K 250 13/190 T Classic	LW-K	3	400	50	190	19	780	5,5	4,0	5,0	3,5	40	54 x 44 x 68
9057 0010	K 250 15/170 T Classic	LW-K	3	400	50	170	17	900	5,5	4,0	5,0	3,5	40	54 x 44 x 68
9057 0012	K 250 11/210 T Classic	LW-K	3	400	50	210	21	660	5,5	4,0	5,0	3,5	40	54 x 44 x 68
9057 0001	K 250 10/150 M Extra	LW-K	1	230	50	150	15	600	3,0	2,2	2,9	3,5	50	54 x 44 x 99
9057 0003	K 250 12/130 M Extra	LW-K	1	230	50	130	13	720	3,0	2,2	2,9	3,5	50	54 x 44 x 99
9057 0005	K 250 11/160 M Extra *	LW-K	1	230	50	160	16	660	3,5	2,6	3,3	3,5	50	54 x 44 x 99
9057 0007	K 250 13/190 T Extra	LW-K	3	400	50	190	19	780	5,5	4,0	5,0	3,5	50	54 x 44 x 99
9057 0009	K 250 15/170 T Extra	LW-K	3	400	50	170	17	900	5,5	4,0	5,0	3,5	50	54 x 44 x 99
9057 0011	K 250 11/210 T Extra	LW-K	3	400	50	210	21	660	5,5	4,0	5,0	3,5	50	54 x 44 x 99

* requires 4 kW single-phase electricity supply - richiede rete elettrica monofase da 4 kW



STANDARD ACCESSORIES › DOTAZIONE STANDARD

CLASSIC		EXTRA	
	GC 251 gun with protection <i>Pistola GC 251 con protezione</i>		GH 301 gun with swivel <i>Pistola GH 301 con swivel</i>
		Bent lance with detergent head, without nozzle <i>Lancia angolata con testina detergente, senza ugello</i>	
		15° spray nozzle, 1/4" MEG connection <i>Ugello con getto a lama 15°, attacco 1/4" MEG</i>	
	10 m rubber delivery hose kit <i>Kit tubo gomma mandata 10 m</i>		Lance with rotating nozzle <i>Lancia con ugello rotante</i>
			15 m rubber delivery hose kit (on Hose Reel - K 250 Extra models) <i>Kit tubo gomma mandata 15 m (su Avvolgitubo - modelli K 250 Extra)</i>

BLUE SERIES PROFESSIONAL



K Premium



MOBILE - PICK UP - STATIC Kit



PREMIUM

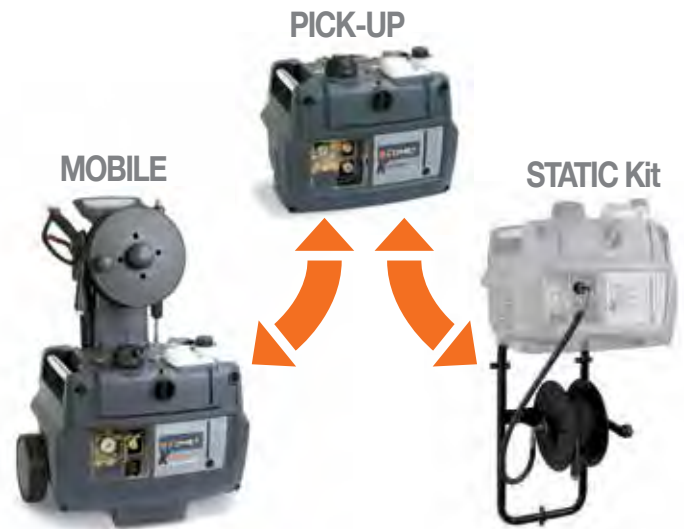

GENERAL FEATURES

- Easy maintenance by simply removing the front casing and taking the electrical pump unit out
- Big wheels (220 mm ø); easy to handle also up and down steps and over uneven ground
- Extractable 3.5 litre detergent tank with level that can be seen externally. Fitted with filter, adjustment knob and an external tank suction system
- **Pump with two oil sight glasses, with level visible from the outside and brass pump head**
- 4-pole motor (1400 rpm) with double bearing, well oversized and protected with paint
- Banjo professional pressure unloader valve
- Timed **TotalStop**
- Rotary switch
- Electrical panel with contactor and thermal relay
- Motor thermal protection



CARATTERISTICHE GENERALI

- *Facilità di manutenzione, con la semplice rimozione della carenatura frontale ed estrazione del gruppo elettropompa*
- *Ruote di grandi dimensioni (ø 220 mm); estrema maneggevolezza anche su gradini e terreno accidentato*
- *Serbatoio detergente da 3,5 litri estraibile, con livello visibile dall'esterno. Dotato di filtro, manopola di regolazione e sistema per aspirazione da serbatoio esterno*
- ***Pompa con doppio visore olio, con livello visibile dall'esterno e testata in ottone***
- *Motore a 4 poli (1400 giri/min) con doppio cuscinetto ampiamente sovradimensionato e protetto da verniciatura*
- *Valvola regolazione professionale flangiata*
- ***TotalStop*** temporizzato
- *Interruttore rotativo*
- *Quadro elettrico con Teleruttore e Relè termico*
- *Protezione termica del motore*
- *Uso professionale*

- Pressure unloader valve with a large and practical knob
- Valvola regolazione pressione, con comoda e grande manopola di presa



- Well balanced for easy handling
- Estrema maneggevolezza grazie alla favorevole posizione del baricentro



- Pump with two oil sight glasses and external level viewer
- Pompa con doppio visore olio, con livello visibile dall'esterno



- Comet RW Premium pump with 3 integral ceramic pistons and brass pump head
- Pompa Comet RW Premium con 3 pistoni in ceramica integrale con testata in ottone



CODE CODICE	MODELS MODELLI	PUMP POMPA	Ph		V		Hz		bar		MPa		l/h		HP		kW		kW		l		kg		(L x W x H) cm	
			Ph	V	Hz	bar	MPa	l/h	HP	kW	kW	l	kg	(L x W x H) cm												
K Premium Pick-Up																										
9050 0513	K Premium 6.13 T	RW	3	400	50	190	19	780	6.0	4.4	5.5	3.5	55	62 x 47 x 51												
9050 0514	K Premium 6.15 T	RW	3	400	50	170	17	900	6.0	4.4	5.5	3.5	55	62 x 47 x 51												
9050 0515	K Premium 8.15 T	RW	3	400	50	210	21	900	7.5	5.5	6.6	3.5	55	62 x 47 x 51												
9050 0540	K Premium 8.21 T	RW	3	400	50	160	16	1260	7.5	5.5	6.9	3.5	55	62 x 47 x 51												
9050 0528	K Premium 9.15 T	RW	3	400	50	230	23	900	9.0	6.6	7.3	3.5	55	62 x 47 x 51												
9050 0519	K Premium 9.21 T	RW	3	400	50	180	18	1260	9.0	6.6	7.5	3.5	55	62 x 47 x 51												
K Premium Mobile																										
9050 0501	K Premium 6.13 T	RW	3	400	50	190	19	780	6.0	4.4	5.5	3.5	55	63 x 59 x 96												
9050 0502	K Premium 6.15 T	RW	3	400	50	170	17	900	6.0	4.4	5.5	3.5	55	63 x 59 x 96												
9050 0503	K Premium 8.15 T	RW	3	400	50	210	21	900	7.5	5.5	6.6	3.5	55	63 x 59 x 96												
9050 0504	K Premium 8.21 T	RW	3	400	50	160	16	1260	7.5	5.5	6.9	3.5	55	63 x 59 x 96												
9050 0505	K Premium 9.15 T	RW	3	400	50	230	23	900	9.0	6.6	7.3	3.5	55	63 x 59 x 96												
9050 0506	K Premium 9.21 T	RW	3	400	50	180	18	1260	9.0	6.6	7.5	3.5	55	63 x 59 x 96												
K Premium Mobile con avvolgitubo - with hose reel																										
9050 0507	K Premium 6.13 T	RW	3	400	50	190	19	780	6.0	4.4	5.5	3.5	55	63 x 59 x 96												
9050 0508	K Premium 6.15 T	RW	3	400	50	170	17	900	6.0	4.4	5.5	3.5	55	63 x 59 x 96												
9050 0509	K Premium 8.15 T	RW	3	400	50	210	21	900	7.5	5.5	6.6	3.5	55	63 x 59 x 96												
9050 0510	K Premium 8.21 T	RW	3	400	50	160	16	1260	7.5	5.5	6.9	3.5	55	63 x 59 x 96												
9050 0511	K Premium 9.15 T	RW	3	400	50	230	23	900	9.0	6.6	7.3	3.5	55	63 x 59 x 96												
9050 0512	K Premium 9.21 T	RW	3	400	50	180	18	1260	9.0	6.6	7.5	3.5	55	63 x 59 x 96												

PICK-UP



- Configuration for stationary use (on a pallet, on a base, on the ground)
- Easy to handle thanks to the practical built-in steel handles
- Configurazione per utilizzo stazionario (su pianale, su base, su terreno)
- Di facile movimentazione grazie alle comode maniglie in acciaio integrate nel telaio della macchina

STATIC Kit



- Wall application kit with heavy duty tubular structure and hose reel
- Configuration for fixed washing points
- Kit applicazione a parete con struttura tubolare robusta ed affidabile con avvolgitubo
- Configurazione per postazioni fisse di lavaggio

STANDARD ACCESSORIES › DOTAZIONE STANDARD

	GH 351 gun with Swivel (n.2 o-ring) Pistola GH 351 con Swivel (n.2 o-ring)		Bent lance with detergent head, without nozzle Lancia angolata con testina detergente, senza ugello
	25° spray nozzle, 1/4" MEG connection Ugello con getto a lama 25° attacco 1/4" MEG		Hose reel with rubber hose (15m for MOBILE models) Avvolgitubo girevole con tubo gomma (15m per modelli MOBILE)
	Rubber delivery hose kit (solo versione MOBILE e PICK-UP) Kit tubo gomma mandata 10 m (MOBILE and PICK-UP version)		

K STEEL



ETM



GENERAL FEATURES

- Easy to transport thanks to a practical top grip and anti-vibration supports
- 2-pole motor (2800 rpm) for continuous use, 4-pole motor (1400 rpm) on ETM 150 model
- Built-in professional unloader valve with ejector (except ETM 71 model)
- **EASY-START** device (except ETM 71 model)
- **TotalStop** device (except ETM 71 model)
- Rotary switch
- Motor thermal protection
- Overheating thermostatic valve on ETM 71 model



CARATTERISTICHE GENERALI

- *Semplicità di trasporto mediante confortevole impugnatura superiore ed appoggio su supporti antivibranti*
- *Motore a 2 poli (2800 giri/min) per uso continuo, motore a 4 poli (1400 giri/min) per modello ETM 150*
- *Valvola di regolazione professionale integrata con eiettore (eccetto modello ETM 71)*
- *Dispositivo **EASY-START** (eccetto modello ETM 71)*
- *Dispositivo **TotalStop** (eccetto modello ETM 71)*
- *Interruttore rotativo*
- *Protezione termica del motore*
- *Valvola termostatica di protezione da sovratemperatura su modello ETM 71*
- *Uso semiprofessionale gravoso (uso professionale per ETM 150)*

- Comet piston pumps with brass head
- *Pompe a pistoni Comet con testata in ottone*



- Brass quick coupling delivery fitting
- *Attacco di mandata con innesto rapido in ottone*



- Pressure regulating knob with anti-tampering device
- *Manopola regolazione pressione con dispositivo antimanomissione*



CODE CODICE	MODELS MODELLI	PUMP POMPA											
			Ph	V	Hz	bar	MPa	l/h	HP	kW	kW	kg	(L x W x H) cm
9055 0006	ETM 71	BWD-K	1	230	50	120	12	420	1,5	1,1	1,5	18	26 x 47 x 37
9055 0004	ETM 100	GXR	1	230	50	130	13	480	2,5	1,9	2,3	23	26 x 47 x 37
9055 0001	ETM 130	AXR	1	230	50	130	13	720	3,0	2,2	2,9	27	26 x 47 x 37
9055 0011	ETM 150	LW-K	1	230	50	150	15	600	3,0	2,2	2,9	35	26 x 47 x 37

STANDARD ACCESSORIES › DOTAZIONE STANDARD

ETM 71		ETM 100 / ETM 130 / ETM 150	
	GC 251 gun with protection <i>Pistola GC 251 con protezione</i>		
	Bent lance with detergent head, without nozzle <i>Lancia angolata con testina detergente, senza ugello</i>		
	15° spray nozzle, 1/4" MEG connection <i>Ugello con getto a lama 15° attacco 1/4" MEG</i>		
	10 m thermoplastic delivery hose kit <i>Kit tubo termostatico 10 m</i>		8 m rubber delivery hose kit <i>Kit tubo mandata 8 m</i>
	Foam lance <i>Lancia schiumogena</i>		

K STEEL

K 803-805-807-809 TS



GENERAL FEATURES

- Heavy duty structure **with stainless steel cover**
- Handy and secure housing of the hose reel (when applicable) in back position on the handlebar
- Readily serviceable brass suction filter
- **Hot water seals**
- 4-pole motor (1400 rpm) well oversized and protected with paint
- Built-in professional unloader valve (**K 803- K 805 only**)
- Bolt-on professional unloader valve (**K 807 - K 809 only**)
- Timed **TotalStop**
- **Exclusive pump-motor coupling system for intensive use (K 807 - K 809 only)**
- Contactor
- Motor thermal protection



CARATTERISTICHE GENERALI

- **Struttura robusta ed affidabile con cofano in acciaio inox**
- **Pratica e sicura collocazione dell'avvolgitubo (quando previsto) in posizione posteriore sul manubrio**
- **Filtro aspirazione in ottone ispezionabile**
- **Guarnizioni ad acqua calda**
- **Motore a 4 poli (1400 giri/min) ampiamente sovradimensionato e protetto da verniciatura**
- **Valvola regolazione pressione professionale integrata (solo K 803- K 805)**
- **Valvola regolazione professionale flangiata (solo K 807 - K 809)**
- **TotalStop temporizzato**
- **Esclusivo sistema accoppiamento pompa - motore per uso intensivo (solo K 807 - K 809)**
- Teleruttore
- Protezione termica motore
- **Uso professionale**

- Big pneumatic wheels (320 mm ø)
- Ruote pneumatiche di grandi dimensioni (ø320mm)



- Comet ZW-K pump with 3 integral ceramic pistons and brass pump head. Two oil sight glasses
- Pompa Comet ZW-K con 3 pistoni in ceramica integrale con testata in ottone. Doppio visore livello olio (solo modelli K803-K805)



- Comet FW2 pump with 3 integral ceramic pistons and brass pump head. Two oil sight glasses (K807-K809 models only)
- Pompa Comet FW2 con 3 pistoni in ceramica integrale con testata in ottone. Doppio visore livello olio (solo modelli K807-K809)



CODE CODICE	MODELS MODELLI	PUMP POMPA											
			Ph	V	Hz	bar	MPa	l/h	HP	kW	kW	kg	(L x W x H) cm
9024 4021	K 803 TS 11/120 M	ZW-K	1	230	50	120	12	660	3,0	2,2	2,9	63	90 x 62 x 84
9024 4023	K 805 TS 15/160 T	ZW-K	3	400	50	160	16	900	5,5	4,0	4,8	63	90 x 62 x 84
9024 4024	K 807 TS 15/210 T	FW2	3	400	50	210	21	900	7,5	5,5	6,5	67	90 x 62 x 84
9024 4025	K 809 TS 21/160 T	FW2	3	400	50	160	16	1260	7,5	5,5	7,0	67	90 x 62 x 84

STANDARD ACCESSORIES › DOTAZIONE STANDARD

	GH 351 gun with Swivel (n.2 o-ring) <i>Pistola GH 351 con Swivel (n.2 o-ring)</i>		Bent lance with detergent head, without nozzle <i>Lancia angolata con testina detergente, senza ugello</i>
	25° spray nozzle, 1/4" MEG connection <i>Ugello con getto a lama 25° attacco 1/4" MEG</i>		10 m rubber delivery hose kit <i>Kit tubo gomma mandata 10 m</i>
		Brass inlet water filter <i>Filtro aspirazione acqua in ottone</i>	

K STEEL

K 891-991 TS



PREMIUM

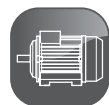

RW Premium

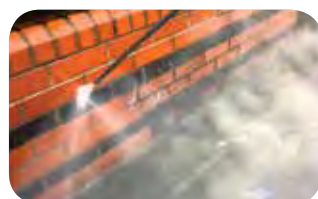

GENERAL FEATURES

- Heavy duty structure **with stainless steel cover**
- Handy and secure housing of the hose reel (when applicable) in back position on the handlebar
- Readily serviceable brass suction filter
- **Hot water seals**
- 4-pole motor (1400 rpm) well oversized and protected with paint
- Professional unloader valve
- Timed **TotalStop**
- **Exclusive pump-motor coupling system for intensive use**
- Contactor
- Motor thermal protection

CARATTERISTICHE GENERALI

- **Struttura robusta ed affidabile con cofano in acciaio inox**
- **Pratica e sicura collocazione dell'avvolgitubo (quando previsto) in posizione posteriore sul manubrio**
- **Filtro aspirazione in ottone ispezionabile**
- **Guarnizioni ad acqua calda**
- **Motore a 4 poli (1400 giri/min) ampiamente sovradimensionato e protetto da verniciatura**
- **Valvola regolazione pressione professionale**
- **TotalStop temporizzato**
- **Esclusivo sistema accoppiamento pompa - motore per uso intensivo**
- **Teleruttore**
- **Protezione termica motore**
- **Uso professionale**

- Pneumatic wheels
- Ruote pneumatiche

- Reversible handlebar for easy handling by pushing
- Manubrio reversibile per movimentazione a spinta

- Stainless steel cover
- Telaio in acciaio inox







- Stainless steel pressure gauge
- Manometro in acciaio inox



CODE CODICE	MODELS MODELLI	PUMP POMPA											
			Ph	V	Hz	bar	MPa	l/h	HP	kW	kW	kg	(L x W x H) cm
9024 4072	K 891 TS 15/230 T	RW	3	400	50	230	23	900	9,0	6,7	7,3	70	90 x 62 x 84
9024 4073	K 891 TS 21/180 T	RW	3	400	50	180	18	1260	9,0	6,7	7,3	70	90 x 62 x 84
9024 4071	K 991 TS 15/270 T	RW	3	400	50	270	27	900	10,0	7,4	8,5	89	115 x 60 x 88
9024 4057	K 991 TS 21/210 T	RW	3	400	50	210	21	1260	10,0	7,4	8,5	89	115 x 60 x 88



STANDARD ACCESSORIES › DOTAZIONE STANDARD

 <p>GH 351 gun with Swivel (n.2 o-ring) <i>Pistola GH 351 con Swivel (n.2 o-ring)</i></p>	 <p>Bent lance with detergent head, without nozzle <i>Lancia angolata con testina detergente, senza ugello</i></p>
 <p>25° spray nozzle, 1/4" MEG connection <i>Ugello con getto a lama 25° attacco 1/4" MEG</i></p>	 <p>10 m rubber delivery hose kit <i>Kit tubo gomma mandata 10 m</i></p>
 <p>Brass inlet water filter <i>Filtro aspirazione acqua in ottone</i></p>	 <p>Ejector kit <i>Kit eiettore</i></p>

K STEEL



K 801-901 ECO PREMIUM



K 809 ECO



GENERAL FEATURES

- Handle with supports for housing the gun, lance, power cable and delivery hose
- **Hot water seals**
- Handy and secure housing of the hose reel (when applicable)
- 4-pole three-phase asynchronous motor (1400 rpm)
- **Exclusive pump-motor coupling system for intensive use**
- Bolt-on professional unloader valve
- Contactor
- Stainless steel frame and casing
- Motor thermal protection
- Timed **TotalStop**



CARATTERISTICHE GENERALI

- *Manico dotato di supporti per l'alloggiamento della pistola, della lancia, del cavo di alimentazione e del tubo mandata*
- **Guarnizioni ad acqua calda**
- *Pratica e sicura collocazione dell'avvolgitubo (quando previsto)*
- *Motore elettrico asincrono trifase 4 poli (1400 giri/min)*
- **Esclusivo sistema di accoppiamento pompa-motore per uso intensivo**
- *Valvola di regolazione flangiata professionale*
- *Teleruttore*
- *Telaio e carena in acciaio inox*
- *Protezione termica del motore elettrico*
- **TotalStop** temporizzato
- *Uso professionale*

- Big wheels in food-industry rubber
- Ruote di grandi dimensioni con rivestimento in gomma antitraccia



- Pressure gauge with stainless steel casing
- Manometro pressione con cassa in acciaio inox



- Comet FW2 and RW Premium pumps with 3 integral ceramic pistons and brass pump head (nickel head for RW).
- Pompe Comet FW2 e RW Premium con 3 pistoni in ceramica integrale con testata in ottone (testata in nickel per RW).



- The hose reel can be mounted on the handle on request
- A richiesta, possibilità di montaggio dell'avvolgitubo sul manubrio



CODE CODICE	MODELS MODELLI	PUMP POMPA											
			Ph	V	Hz	bar	MPa	l/h	HP	kW	kW	kg	(L x W x H) cm
9024 4725	K 809 ECO 21/150	FW2	3	400	50	150	15	1260	7,5	5,5	7,0	67	90 x 62 x 84
9024 4726	K 801 ECO 15/210	RW Premium	3	400	50	210	21	900	9,0	6,6	7,5	70	90 x 62 x 84
9024 4727	K 901 ECO 21/180	RW Premium	3	400	50	180	18	1260	9,0	6,6	7,5	70	90 x 62 x 84

STANDARD ACCESSORIES › DOTAZIONE STANDARD

	GH 351 stainless steel gun with Swivel and ball quick coupler <i>Pistola GH 351 inox con Swivel + attacco rapido a sfere</i>		Stainless steel bent lance, adjustable head, with ball quick coupler without nozzle <i>Lancia angolata inox, testina regolabile + attacco rapido a sfere senza ugello</i>
	S. Steel fan shape nozzle 25°, 1/4" MEG connection <i>Ugello inox con getto a lama 25° attacco 1/4" MEG</i>		10 m BLUE food industry rubber delivery hose kit <i>Kit tubo gomma mandata 10 m BLU anti-traccia</i>
		Brass inlet water filter <i>Filtro aspirazione acqua in ottone</i>	

K STEEL



K 1001-1251-1501 TS

**PREMIUM**

SW / TW Premium



GENERAL FEATURES

- Heavy duty structure **with stainless steel cover**
- High filtering capacity cartridge self-cleaning suction filter
- Pressure gauge with stainless steel casing
- **Hot water seals**
- 4-poles (1400 rpm) motor well oversized and protected with paint
- Pneumatic wheels with steel hub and air chamber
- Highly professional unloader valve with external bypass
- Motor-pump coupling by means of a flexible joint
- FLOW-SENSITIVE timed **TotalStop**
- Low voltage control panel
- Contactor
- Thermal relay motor protection



CARATTERISTICHE GENERALI

- **Struttura robusta ed affidabile con cofano in acciaio inox**
- **Filtro aspirazione autopulente a cartuccia di alta portata, con alto potere filtrante**
- **Manometro pressione con cassa in inox**
- **Guarnizioni ad acqua calda**
- **Motore a 4 poli (1400 giri/min) ampiamente sovradimensionato e protetto da verniciatura**
- **Ruote schiumate con mozzo in acciaio ad effetto pneumatico**
- **Valvola regolazione altamente professionale con by-pass esterno**
- **Accoppiamento motore-pompa mediante giunto elastico**
- **TotalStop temporizzato FLOW-SENSITIVE**
- **Quadri Comando in bassa tensione**
- **Teleruttore**
- **Protezione del motore con relè termico**
- **Uso professionale continuo**

- The stainless steel hose reel can be mounted on request, with 20-40-60 m hose.
- *A richiesta, possibilità di montaggio dell'avvolgitubo interamente in acciaio inox con tubo da 20, 40, 60 metri*

- Practical and safe housing accessories, all with ball quick coupler
- *Pratico e sicuro alloggiamento degli accessori, tutti con attacco rapido a sfere*

- Unloader valve and pressure accumulator
- *Valvola di regolazione e accumulatore di pressione*

- Stainless steel frame on request. Protective panels version on request.
- *Versione con telaio inox fornibile su richiesta. Versione con pannelli protettivi fornibile su richiesta.*



CODE CODICE	MODELS MODELLI	PUMP POMPA											
			Ph	V	Hz	bar	MPa	l/h	HP	kW	kW	kg	(L x W x H) cm
9059 0351	K 1001 TS 21/210	SW Premium	3	400	50	210	21	1260	10,0	7,3	8,5	158	90 x 75 x 95
9059 0352	K 1001 TS 28/160	TW Premium	3	400	50	160	16	1680	10,0	7,3	8,5	158	90 x 75 x 95
9059 0353	K 1251 TS 21/250	SW Premium	3	400	50	250	25	1260	12,0	8,8	10,0	161	90 x 75 x 95
9059 0354	K 1251 TS 33/160	TW Premium	3	400	50	160	16	1980	12,0	8,8	10,0	161	90 x 75 x 95
9059 0355	K 1501 TS 42/130	TW Premium	3	400	50	130	13	2520	15,0	11,0	12,0	163	90 x 75 x 95
9059 0357	K 1501 TS 18/350	TW Premium	3	400	50	350	35	1080	15,0	11,0	12,0	163	90 x 75 x 95

On request, available 440V 60Hz models - *Disponibili su richiesta modelli a 440V 60Hz*



STANDARD ACCESSORIES › DOTAZIONE STANDARD

	RL51 gun with swivel and ball quick coupler <i>(RL56 gun on K1501 models)</i> <i>Pistola RL 51 con Swivel e attacco rapido a sfere</i> <i>(pistola RL56 su modelli K1501)</i>		Stainless steel double (single on 18/350 model) barrel lance with ball quick coupler, without nozzle <i>Lancia canna doppia (singola sul modello 18/350) inox con attacco rapido a sfere, senza ugello</i>
	25° spray nozzle, 1/4" MEG connection <i>Ugello con getto a lama 25° attacco 1/4" MEG</i>		Detergent nozzle for double barrel lance, 1/4" MEG connection (not on 18/350 model) <i>Ugello detergente per lancia canna doppia, attacco 1/4" MEG (non sul modello 18/350)</i>
	Self cleaning water filter <i>Filtro acqua autopulente</i>		10 mt delivery rubber hose kit, with quick coupler <i>Kit tubo gomma mandata 10 mt, con attacco rapido</i>

K STEEL



K Xtreme



PREMIUM



TW Premium



TW 500 Premium



GENERAL FEATURES

- Sturdy frame painted with anti-corrosive treatment
- **Stainless-steel cover panel**
- Handy lance and gun storage
- High filtering capacity cartridge self-cleaning suction filter
- Pneumatic wheels with steel hub and air chamber
- Electric motor (1400 rpm) 20, 25 and 30 HP
- Comet TW Premium triplex pumps
- Motor-pump coupling by means of a flexible joint
- Automatic unloader valve with external by-pass and gradual pressure restoring
- Overheating thermostatic valve
- **Low voltage (24V) industrial start-up panel (star-delta on 25-30 HP models)**
- Remote switch and motor cut-out with thermal relay
- Emergency stop button
- Hour counter



CARATTERISTICHE GENERALI

- **Robusto telaio verniciato con trattamenti anticorrosivi**
- **Pannello di rivestimento in acciaio inox**
- Pratico alloggiamento di pistola e lancia
- Filtro aspirazione autopulente a cartuccia ampiamente sovradimensionato, con alto potere filtrante
- Ruote schiumate con mozzo in acciaio ad effetto pneumatico
- Motore elettrico (1400 giri/min) 20, 25 e 30 HP
- Pompe triplex Comet TW Premium
- Accoppiamento motore pompa mediante giunto elastico
- Valvola automatica di regolazione con by-pass esterno e ripristino graduale della pressione
- Valvola termostatica di protezione da sovratemperatura
- **Quadro di avviamento diretto con comandi in bassa tensione (24V), (stella triangolo su modelli 25-30 HP)**
- Teleruttore e protezione del motore con relè termico
- Pulsante di arresto di emergenza
- Contatore
- **Uso altamente professionale**

- Motor-pump coupling with a flexible joint
- *Accoppiamento motore pompa mediante giunto elastico*



- Hose reel can be mounted on request
- *A richiesta, possibilità di montaggio dell'avvolgitubo*



- Protective panels version on request.
- *Versione con pannelli protettivi fornibile su richiesta.*



CODE CODICE	MODELS MODELLI	PUMP POMPA											
			Ph	V	Hz	bar	MPa	l/h	HP	kW	kW	kg	(L x W x H) cm
9059 0001	K Xtreme 15/500	TW Premium 500	3	400	50	500	50	900	20,0	14,7	15,0	175	100 x 75 x 85
9059 0002	K Xtreme 21/350	TW Premium 500	3	400	50	350	35	1260	20,0	14,7	15,0	175	100 x 75 x 85
9059 0003	K Xtreme 33/250	TW Premium	3	400	50	250	25	1980	20,0	14,7	15,0	175	100 x 75 x 85
9059 0004	K Xtreme 18/500	TW Premium 500	3	400	50	500	50	1080	25,0	18,4	18,5	185	100 x 75 x 85
9059 0005	K Xtreme 21/450	TW Premium 500	3	400	50	450	45	1260	25,0	18,4	18,5	185	100 x 75 x 85
9059 0006	K Xtreme 42/200	TW Premium	3	400	50	200	20	2520	25,0	18,4	18,5	185	100 x 75 x 85
9059 0014	K Xtreme 21/500	TW Premium 500	3	400	50	500	50	1260	30,0	22,1	23,0	200	100 x 75 x 85



STANDARD ACCESSORIES › DOTAZIONE STANDARD

 <p>GH 501 stainless steel spray gun with quick couplers <i>Pistola GH 501 inox con attacchi rapidi</i></p>	 <p>Straight stainless steel lance, with adjustable handle <i>Lancia inox dritta, con impugnatura regolabile</i></p>
 <p>Flat stainless-steel spray nozzle (15° or 25°) with ceramic insert (available on request in s/s-tungsten material) <i>Ugello inox getto piatto 15° o 25° con inserto in ceramica (disponibile su richiesta in materiale inox/tungsteno)</i></p>	 <p>20 mt delivery hose kit with quick coupler M24x1,5 <i>Kit tubo mandata 20 mt con attacchi rapidi M24x1,5</i></p>
 <p>Self cleaning water filter <i>Filtro acqua autopulente</i></p>	



FDX 2



2 wheels - 2 ruote



FDX 2 10/150 - VRX

GENERAL FEATURES - CARATTERISTICHE GENERALI

- Loncin G 160 F Engine
- **Comet VRX 3 axial piston pump with brass pump head**
- Readily serviceable suction filter
- Professional unloader valve
- No engine oil safety device (oil-alert)
- **Motore Loncin G 160 F**
- **Pompa Comet a 3 pistoni assiali VRX, con testata in ottone**
- **Filtro aspirazione ispezionabile**
- **Valvola regolazione professionale**
- **Dispositivo di sicurezza mancanza olio motore (oil-alert)**
- **Uso semiprofessionale**

FDX 2 12/200 - BXD

GENERAL FEATURES - CARATTERISTICHE GENERALI

- Loncin G 200 F Engine
- **Comet BXD self-priming pump with 3 axial integral ceramic pistons and brass pump head**
- Regulated low-pressure detergent suction
- Readily serviceable suction filter
- Professional unloader valve
- No engine oil safety device (oil-alert)
- **Motore Loncin G 200 F**
- **Pompa Comet BXD autoadescante con 3 pistoni assiali in ceramica e testata in ottone**
- **Aspirazione detergente in bassa pressione con regolazione**
- **Filtro aspirazione ispezionabile**
- **Valvola regolazione professionale**
- **Dispositivo di sicurezza mancanza olio motore (oil-alert)**
- **Uso semiprofessionale**

FDX 2 - BXD / AXD

GENERAL FEATURES - CARATTERISTICHE GENERALI

- Honda GP or GX series engine
- **No engine-oil safety device (oil-alert)**
- **Comet BXD-AXD self-priming pumps with 3 axial ceramic pistons and brass pump head**
- Regulated low-pressure detergent suction
- Readily serviceable suction filter
- Professional unloader valve
- No engine oil safety device (oil-alert)
- **Motore Honda serie GP o GX**
- **Dispositivo di Sicurezza mancanza olio motore**
- **Pompe Comet BXD-AXD autoadescanti con 3 pistoni assiali in ceramica e testata in ottone**
- **Aspirazione detergente in bassa pressione con regolazione**
- **Filtro aspirazione ispezionabile**
- **Valvola regolazione professionale**
- **Dispositivo di sicurezza mancanza olio motore (oil-alert)**
- **Uso semiprofessionale**

FDX 2 - BWD-K / ZWD / ZWD-K

GENERAL FEATURES - CARATTERISTICHE GENERALI

- Honda GX series engine
- **No engine-oil safety device (oil-alert)**
- **Comet BWD, ZWD, ZWD-K self-priming triplex pumps, 3 ceramic pistons, brass pump head, bronze conrods**
- Regulated low-pressure detergent suction
- Readily serviceable suction filter
- Professional unloader valve
- No engine oil safety device (oil-alert)
- **Motore Honda serie GX**
- **Dispositivo di Sicurezza mancanza olio motore**
- **Pompe Comet BWD, ZWD, ZWD-K triplex autoadescanti, 3 pistoni in ceramica, testata ottone, bielle in bronzo**
- **Aspirazione detergente in bassa pressione con regolazione**
- **Filtro aspirazione ispezionabile**
- **Valvola regolazione professionale**
- **Dispositivo di sicurezza mancanza olio motore (oil-alert)**
- **Uso semiprofessionale**

- Easy to handle up and down steps and over uneven ground
- *Facilità di movimento su gradini e fondi sconnessi*



- Well balanced for easy handling
- *Estrema maneggevolezza grazie alla favorevole posizione del baricentro*



CODE CODICE	MODELS MODELLI	PUMP POMPA	Pressure		Flow rate	Power	Weight	Dimensions
			bar	MPa				
9020 0155	FDX 2 10/150 - Loncin G160 F	VRX	150	15	600	5,0	27	67 x 55 x 89
9020 0160	FDX 2 12/200 - Loncin G200 F	BXD	200	20	720	6,0	30	67 x 55 x 89
9020 0311	FDX 2 13/150 - Honda GP160	BXD	150	15	780	5,0	30	67 x 55 x 89
9020 0312	FDX 2 12/200 - Honda GP200	BXD	200	20	720	6,0	30	67 x 55 x 89
9020 0304	FDX 2 14/200 - Honda GX270	AXD	200	20	840	7,5	38	67 x 55 x 89
9020 0313	FDX 2 12/140 - Honda GP160	BWD-K	140	14	720	5,5	30	67 x 55 x 89
9020 0306	FDX 2 13/180 - Honda GX200	BWD-K	180	18	780	6,0	35	67 x 55 x 89
9020 0308	FDX 2 16/210 - Honda GX340	ZWD-K	210	21	960	11,0	48	67 x 55 x 89
9020 0309	FDX 2 16/250 - Honda GX390	ZWD	250	25	960	13,0	50	67 x 55 x 89
9020 0310	FDX 2 15/270 - Honda GX390	ZWD-K	270	27	900	13,0	50	67 x 55 x 89



STANDARD ACCESSORIES › DOTAZIONE STANDARD

FDX2 Loncin

	Gun GC 251 with protection <i>Pistola con protezione GC 251</i>
	Bent lance with detergent head, without nozzle <i>Lancia angolata con testina detergente, senza ugello</i>
	Fan shape nozzle 15°, 1/4" MEG connection <i>Ugello con getto a lama 15°, attacco 1/4" MEG</i>
	8 m rubber delivery hose kit <i>Kit tubo gomma mandata 8 m</i>
	Foam lance (only for 10/150 model) <i>Lancia schiumogena (solo per modello 10/150)</i>

FDX2 Honda

	GH 301 gun with Swivel <i>Pistola GH 301 con Swivel</i>
	Bent lance with detergent head, without nozzle <i>Lancia angolata con testina detergente, senza ugello</i>
	Fan shape nozzle 25°, 1/4" MEG connection <i>Ugello con getto a lama 25°, attacco 1/4" MEG</i>
	10 m rubber delivery hose kit (8 m for 13/150 - 12/200 - 12/140 models) <i>Kit tubo gomma mandata 10 m (8 m per modelli 13/150 - 12/200 - 12/140)</i>

X-SPECIAL COLD WATER



FDX PRO



4 wheels - 4 ruote



PREMIUM



ZWD-K



RW



FW2



GENERAL FEATURES

- With 4 wheels of which 2 castors
- Honda GX series engine (petrol models) or Yanmar L70 engine (Diesel model)
- No engine-oil safety device (oil-alert) (Honda engine only)
- **Automatic decelerator to reduce RPM in the bypass phase (Honda engine only)**
- **Gearbox (with 1560 rpm pump) (Honda engine only)**
- Regulated low-pressure detergent suction
- Readily serviceable brass suction filter
- Water suction from external tank option (self-priming pumps)
- Overheating thermostatic valve



CARATTERISTICHE GENERALI

- *Con 4 ruote di cui 2 pivotanti*
- *Motore Honda serie GX (modelli a benzina) o Yanmar L70 (modello Diesel)*
- *Dispositivo di Sicurezza mancanza olio motore (solo motore Honda)*
- ***Deceleratore automatico per la riduzione del numero di giri in fase di by-pass (solo motore Honda)***
- ***Riduttore di giri (con pompa a 1560 rpm) (solo motore Honda)***
- *Aspirazione del detergente in bassa pressione con regolazione*
- *Filtro aspirazione in ottone facilmente ispezionabile*
- *Possibilità di aspirare acqua da serbatoio esterno (pompe autoadescanti)*
- *Valvola termostatica di protezione da sovratemperatura*
- *Uso professionale*

- Easy handling thanks to the big pneumatic wheels
- *Facilità di movimento grazie alle ruote pneumatiche di grandi dimensioni*



- Comet RW Premium, FW2 pumps with 3 ceramic pistons and brass pump head
- *Pompe Comet RW Premium, FW2 con 3 pistoni in ceramica e testata in ottone*



- The hose reel can be mounted on the handle on request
- *A richiesta possibilità di montaggio dell'avvolgitubo sul manubrio*



- RPM deceleration kit
- *Kit deceleratore di giri motore*



CODE CODICE	MODELS MODELLI	PUMP POMPA	Pressure		Flow l/h	Power HP	Weight kg	Dimensions (L x W x H) cm
			bar	MPa				
Diesel Engines - Motori diesel								
9020 0114	FDX PRO 15/150 - Yanmar L70	ZWD-K	150	15	900	7,5	60	116 x 62 x 71
Petrol engines - Motori a benzina								
9020 0087	FDX PRO 16/200 - Honda GX340	FW2	200	20	960	11,0	82	116 x 62 x 71
9020 0090	FDX PRO 16/200 - Honda GX340 + AVT	FW2	200	20	960	11,0	87	116 x 62 x 71
9020 0132	FDX PRO 15/270 - Honda GX390	RW	270	27	900	13,0	82	116 x 62 x 71
9020 0146	FDX PRO 15/270 - Honda GX390 + AVT	RW	270	27	900	13,0	87	116 x 62 x 71
9020 0144	FDX PRO 15/300 - Honda GX390	RW	300	30	900	13,0	82	116 x 62 x 71
9020 0145	FDX PRO 15/300 - Honda GX390 + AVT	RW	300	30	900	13,0	87	116 x 62 x 71
9020 0116	FDX PRO 16/250 - Honda GX390	RW	250	25	960	13,0	82	116 x 62 x 71
9020 0117	FDX PRO 16/250 - Honda GX390 + AVT	RW	250	25	960	13,0	87	116 x 62 x 71
9020 0118	FDX PRO 18/220 - Honda GX390	RW	220	22	1080	13,0	82	116 x 62 x 71
9020 0119	FDX PRO 18/220 - Honda GX390 + AVT	RW	220	22	1080	13,0	87	116 x 62 x 71



STANDARD ACCESSORIES › DOTAZIONE STANDARD

	GH 351 gun with Swivel (n.2 o-ring) <i>Pistola GH 351 con Swivel (n.2 o-ring)</i>		Double barrel lance, without nozzle <i>Lancia a canna doppia senza ugello</i>
	Fan shape nozzle 25°, 1/4" MEG connection <i>Ugello con getto a lama 25° attacco 1/4" MEG</i>		Detergent nozzle for double barrel lance, 1/4" MEG connection <i>Ugello detergente per lancia canna doppia, attacco 1/4" MEG</i>
	10 m rubber delivery hose kit <i>(for models without hose reel)</i> <i>Kit tubo gomma mandata 10 m</i> <i>(per modelli senza avvolgitubo)</i>		15 m hose reel <i>(for models with hose reel)</i> <i>Avvolgitubo 15 m</i> <i>(per modelli con avvolgitubo)</i>
	Brass inlet water filter <i>Filtro aspirazione acqua in ottone</i>		Thermostatic Valve (optimal functioning when supplied with tap water pressure) <i>Valvola termostatica (funzionamento ottimale solo se alimentata in pressione)</i>



FDX 4



4 wheels - 4 ruote



PREMIUM



GENERAL FEATURES

- With 4 pneumatic wheels
- Honda GX series engine (petrol models) or Yanmar L100 engine (Diesel model)
- **Electrical starting**
- No engine-oil safety device (oil-alert)
- **Automatic decelerator to reduce the number of revs in the bypass phase (on petrol engines)**
- **Gearbox (with 1560 rpm pump)**
- Regulated low-pressure detergent suction
- Big water filter at pump inlet
- Water suction from external tank option (self-priming pumps)
- Overheating thermostatic valve



CARATTERISTICHE GENERALI

- Con 4 ruote pneumatiche
- Motore Honda Serie GX (modelli a benzina) o Yanmar L100 (modello Diesel)
- **Avviamento elettrico**
- Dispositivo di Sicurezza mancanza olio motore
- **Deceleratore automatico per la riduzione del numero di giri in fase di by-pass (su motori benzina)**
- **Riduttore di giri (con pompa a 1560 rpm)**
- Aspirazione detergente in bassa pressione con regolazione
- Filtro acqua di grande dimensione in ingresso pompa
- Possibilità di aspirare acqua da serbatoio esterno (pompe autoadescenti)
- Valvola termostatica di protezione da sovratemperatura
- Uso professionale

- Easy handling thanks to the big pneumatic wheels
- *Facilità di movimento grazie alle ruote pneumatiche di grandi dimensioni*



- Comet RW Premium, FW2 pumps with 3 ceramic pistons and brass pump head
- *Pompe Comet RW Premium, FW2 con 3 pistoni in ceramica e testata in ottone*



- RPM deceleration kit only for petrol engine models
- *Kit deceleratore di giri motore solo modelli motore a benzina*



CODE CODICE	MODELS MODELLI	PUMP POMPA	Pressure		Flow l/h	Power HP	Weight kg	Dimensions (L x W x H) cm
			bar	MPa				
Diesel Engines - Motori diesel								
9020 0057	FDX 4 16/200 - Yanmar L100 - Diesel with electrical and battery starting con avviamento elettrico e batteria	FW2	200	20	960	11,0	124	89 x 77 x 86
9020 0070	FDX 4 21/160 - Yanmar L100 - Diesel with electrical and battery starting con avviamento elettrico e batteria	FW2	160	16	1260	11,0	124	89 x 77 x 86
Petrol engines - Motori a benzina								
9020 0049	FDX 4 16/200 - Honda GX340 with decelerator - con deceleratore	FW2	200	20	960	11,0	72	89 x 77 x 86
9020 0121	FDX 4 16/250 - Honda GX390 with electrical and battery starting and decelerator - con avviam. elett., batteria e deceleratore	RW	250	25	960	13,0	82	89 x 77 x 86
9020 0120	FDX 4 16/250 - Honda GX390 with decelerator - con deceleratore	RW	250	25	960	13,0	72	89 x 77 x 86
9020 0150	FDX 4 18/220 - Honda GX390 with electrical and battery starting and decelerator - con avviam. elett., batteria e deceleratore	RW	220	22	1080	13,0	82	89 x 77 x 86
9020 0123	FDX 4 18/220 - Honda GX390 with decelerator - con deceleratore	RW	220	22	1080	13,0	72	89 x 77 x 86
9020 0152	FDX 4 21/200 - Honda GX390 with electrical and battery starting and decelerator - con avviam. elett., batteria e deceleratore	RW	200	20	1260	13,0	82	89 x 77 x 86
9020 0151	FDX 4 21/200 - Honda GX390 with decelerator - con deceleratore	RW	200	20	1260	13,0	82	89 x 77 x 86



STANDARD ACCESSORIES › DOTAZIONE STANDARD

	GH 351 gun with Swivel (n.2 o-ring) <i>Pistola GH 351 con Swivel (n.2 o-ring)</i>		Double barrel lance, without nozzle <i>Lancia a canna doppia senza ugello</i>
	Fan shape nozzle 25°, 1/4" MEG connection <i>Ugello con getto a lama 25° attacco 1/4" MEG</i>		Detergent nozzle for double barrel lance, 1/4" MEG connection <i>Ugello detergente per lancia canna doppia, attacco 1/4" MEG</i>
	10 m rubber delivery hose kit <i>Kit tubo gomma mandata 10 m</i>		Brass inlet water filter <i>Filtro aspirazione acqua in ottone</i>
	Thermostatic Valve (optimal functioning when supplied with tap water pressure) <i>Valvola termostatica (funzionamento ottimale solo se alimentata in pressione)</i>		

X-SPECIAL COLD WATER



FDX Xtreme



4 wheels - 4 ruote

PREMIUM



GENERAL FEATURES

- 4 wheels with foamed-acting pneumatic
- Engines: Honda GX 690 (petrol versions) or Kohler 12KD477/2 (diesel versions)
- Gearbox (with 1560 rpm pump)
- Electrical starting
- No engine-oil safety device (oil-alert)
- Hours meter
- Automatic decelerator to reduce the number of revs in the bypass phase
- Stainless steel gradual pressure restoration valve with EASY-START
- Thermostatic valve
- Big water filter at pump inlet, readily serviceable cartridge type
- Water suction from external tank option (self-priming pumps)
- Suitable for high professional use



CARATTERISTICHE GENERALI

- 4 ruote schiumate con effetto pneumatico
- Motori: Honda GX 690 (versioni benzina) oppure Kohler 12KD477/2 (versioni diesel)
- Riduttore di giri (con pompa a 1560 rpm)
- Avviamento elettrico
- Dispositivo di Sicurezza mancanza olio motore (oil-alert)
- Contatore
- Deceleratore automatico per la riduzione del numero di giri in fase di by-pass
- Valvola a ripristino graduale della pressione in acciaio inox con EASY-START
- Valvola termostatica
- Filtro acqua di grande dimensione in ingresso pompa a cartuccia ispezionabile
- Possibilità di aspirare acqua da serbatoio esterno (pompe autoadescanti)
- Uso altamente professionale

- Rear wheel with brake
- Ruota posteriore dotata di freno

- Comet TW, TW 500 bar Premium pump with 3 ceramic plungers and brass pump head
- Pompa Comet TW, TW 500 bar Premium, con 3 pistoni in ceramica e testata in ottone

- The hose reel can be mounted on request
- A richiesta possibilità di montaggio dell'avvolgitubo

- RPM deceleration kit only for petrol engine models
- Kit deceleratore di giri motore solo modelli motore a benzina



CODE CODICE	MODELS MODELLI	PUMP POMPA	Pressure		l/h	HP	kg	(L x W x H) cm
			bar	MPa				
Petrol Engines (Honda GX 690) - Motore benzina (Honda GX690)								
9058 0001	FDX Xtreme 15/500	TW Premium 500	500	50	900	22,0	150	100 x 82 x 85
9058 0002	FDX Xtreme 18/400	TW Premium 500	400	40	1080	22,0	150	100 x 82 x 85
9058 0003	FDX Xtreme 21/350	TW Premium 500	350	35	1260	22,0	150	100 x 82 x 85
9058 0004	FDX Xtreme 30/280	TW Premium	280	28	1800	22,0	150	100 x 82 x 85
9058 0005	FDX Xtreme 36/230	TW Premium	230	23	2160	22,0	150	100 x 82 x 85
9058 0006	FDX Xtreme 42/180	TW Premium	180	18	2520	22,0	150	100 x 82 x 85
Diesel Engines (Kohler 12KD477/2) - Motore diesel (Kohler 12KD477/2)								
9058 0007	FDX Xtreme 15/500	TW Premium 500	500	50	900	22,8	190	100 x 82 x 85
9058 0008	FDX Xtreme 18/400	TW Premium 500	400	40	1080	22,8	190	100 x 82 x 85
9058 0009	FDX Xtreme 21/350	TW Premium 500	350	35	1260	22,8	190	100 x 82 x 85
9058 0010	FDX Xtreme 30/280	TW Premium	280	28	1800	22,8	190	100 x 82 x 85
9058 0011	FDX Xtreme 36/230	TW Premium	230	23	2160	22,8	190	100 x 82 x 85
9058 0012	FDX Xtreme 42/180	TW Premium	180	18	2520	22,8	190	100 x 82 x 85

STANDARD ACCESSORIES › DOTAZIONE STANDARD

	<p>Stainless steel GH 501 spray gun with quick couplers <i>Pistola GH 501 inox con attacchi rapidi</i></p>		<p>Straight stainless steel lance, with adjustable handle <i>Lancia inox dritta, con impugnatura regolabile</i></p>
	<p>Flat stainless-steel jet nozzle (15° or 25°) with ceramic insert (available on request in s/s-tungsten material) <i>Ugello inox getto piatto 15° o 25° con inserto in ceramica (disponibile su richiesta in materiale inox/tungsteno)</i></p>		<p>20 mt delivery hose kit with quick coupler M24x1,5 <i>Kit tubo mandata con attacchi rapidi M24x1,5</i></p>
		<p>Self cleaning water filter <i>Filtro acqua autopulente</i></p>	

X-SPECIAL COLD WATER



FDX WB



LWD-K



BWD-K



GENERAL FEATURES

- 120 l polyethylene tank
- Painted steel frame
- Wheels with puncture-proof tyres
- Honda GX160 and Loncin G200F engines
- Comet LWD-K and BWD-K self-priming triplex pumps, with ceramic pistons and brass pump head
- Professional unloader valve
- Suction filter (readily serviceable external filter at pump inlet)
- Regulated low-pressure detergent suction
- GH301 spray gun with swivel
- Hose reel with 15m G1/4 hose
- Semi-professional use

CARATTERISTICHE GENERALI

- Cisterna 120 LT in polietilene
- Telaio in acciaio verniciato
- Ruote con gomma anti-foratura
- Motori Honda GX160 e Loncin G200F
- Pompe Comet LWD-K e BWD-K, triplex autoadescanti, a pistoni in ceramica e testata in ottone
- Valvola di regolazione professionale
- Filtro in aspirazione (filtro esterno ispezionabile in ingresso pompa)
- Aspirazione detergente in bassa pressione con regolazione
- Pistola GH301 con swivel
- Avvolgitubo con 15mt tubo G1/4
- Uso semiprofessionale

- Readily serviceable external suction filter
- *Filtro aspirazione esterno ispezionabile*



- 15 m hose reel
- *Avvolgitubo 15 m*



- Comet Triplex pump, ceramic pistons and brass head
- *Pompa triplex Comet con testata in ottone*



CODE CODICE	MODELS MODELLI	PUMP POMPA						
			bar	MPa	l/h	HP	kg	(L x W x H) cm
9020 0801	FDX WB 8/160 Honda GX 160	LWD-K	160	16	480	5,5	70	120 x 80 x 110
9020 0802	FDX WB 8/160 Loncin G 200 F	BWD-K	160	16	480	6,0	70	120 x 80 x 110

STANDARD ACCESSORIES › DOTAZIONE STANDARD

<p>GH 301 gun with Swivel <i>Pistola GH 301 con Swivel</i></p>	<p>Bent lance with detergent head, without nozzle <i>Lancia angolata con testina detergente, senza ugello</i></p>
<p>Fan shape nozzle 25°, 1/4" MEG connection <i>Ugello con getto a lama 25°, attacco 1/4" MEG</i></p>	<p>15 m hose reel <i>Avvolgitubo 15 m</i></p>

X-SPECIAL COLD WATER



PTO



PREMIUM



GENERAL FEATURES

- Also available with compact closing frame (71x85x15 cm)
- RW pumps with 1450 rpm gearbox kit
- With TWN pump for direct application
- Water suction from external tank option (self-priming pumps)
- Professional pressure unloader valve
- Shield for cardan shaft
- Readily serviceable brass water suction filter
- Pressure Gauge



CARATTERISTICHE GENERALI

- Disponibile anche completa di telaio richiudibile e di ridotte dimensioni (71x85x15 cm)
- Pompe RW con moltiplicatore a 1450 giri/min
- Con pompa TWN per applicazione diretta
- Possibilità di aspirare acqua da serbatoio esterno (pompe autoadescanti)
- Valvola di regolazione pressione professionale
- Protezione Albero Cardanico
- Filtro aspirazione acqua in ottone, facilmente ispezionabile
- Manometro di pressione
- Uso professionale

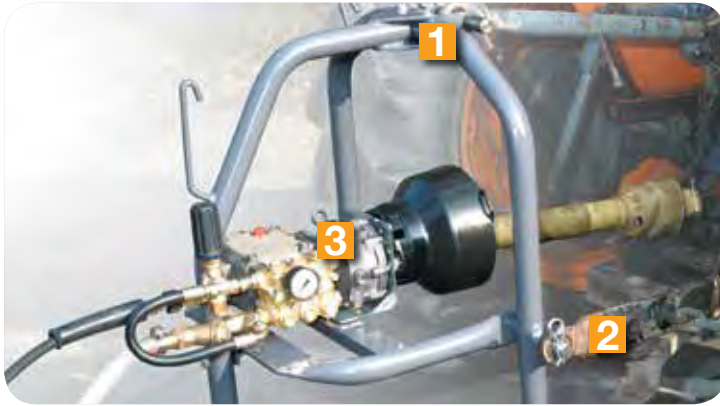

- 1 Coupling for tractor's 3rd linkage point, diam. 19 - 25 mm
- 2 22 mm diameter pins for 3-point hitch
- 3 Gearbox kit for 1450 rpm pumps (RW)

- 1 Attacco al terzo punto trattore diam. 19 - 25 mm
- 2 Pini diametro 22 mm per attacco ai bracci del sollevatore
- 3 Moltiplicatore per pompe a 1450 giri/min (RW)



- Comet TWN and RW Premium pumps with 3 integral ceramic pistons and brass pump head. Two oil sight glasses
- Pompe Comet TWN e RW Premium con 3 pistoni in ceramica integrale con testata in ottone. Doppio visore livello olio



CODE CODICE	MODELS MODELLI	PUMP POMPA				
			bar	MPa	l/h	kW
PTO Premium with frame - con telaio						
9045 0014 *	PTO 21/200	RW	200	20	1260	8,5
9045 0003 ●	PTO 23/200	TWN	200	20	1380	10,0
9045 0005 ●	PTO 30/170	TWN	170	17	1800	11,0
PTO Premium without frame - senza telaio						
9045 0017 *	PTO 15/150	RW	150	15	900	5,5
9045 0016 *	PTO 21/200	RW	200	20	1260	8,5
9045 0008 ●	PTO 23/200	TWN	200	20	1380	10,0
9045 0010 ●	PTO 30/170	TWN	170	17	1800	11,0

- * with gearbox kit (540 rpm PTO) - con moltiplicatore (PTO 540 giri/min)
- without gearbox kit (1000 rpm PTO) - senza moltiplicatore (PTO 1000 giri/min)

 STANDARD ACCESSORIES › DOTAZIONE STANDARD

	GH 351 gun with Swivel, n. 2 o-ring <i>Pistola GH 351 con swivel, n. 2 o-ring</i>		Bent double barrel lance, without nozzles <i>Lancia a canna doppia angolata, senza ugelli</i>
	Detergent nozzle for double barrel lance, 1/4" MEG connection <i>Ugello detergente per lancia canna doppia, attacco 1/4" MEG</i>		Fan shape nozzle 25°, 1/4" MEG connection <i>Ugello con getto a lama 25° attacco 1/4" MEG</i>
	10 m rubber delivery hose kit <i>Kit tubo gomma mandata 10 m</i>		Water suction filter <i>Filtro aspirazione acqua</i>



FDX Hot Cube

PED
97 / 23 / CE
cat. II



GENERAL FEATURES

- Professional hot water high pressure cleaner for uses without connection to electricity grid
- Honda GX 390 engine (petrol models) or Yanmar L100 engine (diesel models)
- **Electrical starting-up**
- No engine-oil safety device (oil-alert)
- **Automatic decelerator to reduce the number of revs in the bypass phase**
- **Gearbox**
- Fuel tank with level float and fill up filter
- Professional gradual pressure restoration unloader valve
- Double coil vertical boiler with stainless steel outer casing
- Electronic temperature setting system with constant water temperature
- **PED 97/23/CE cat. II certification**
- Flow-switch operated burner
- Safety valve
- Boiler thermal protection
- Flame control kit

CARATTERISTICHE GENERALI

- *Idropultrice professionale a caldo per utilizzo senza allacciamento alla rete elettrica*
- *Motore Honda GX 390 (modelli a benzina) o Yanmar L100 (modelli diesel)*
- **Avviamento elettrico**
- *Dispositivo di Sicurezza mancanza olio motore*
- **Deceleratore automatico per la riduzione del numero di giri in fase di by-pass**
- **Riduttore di giri**
- *Serbatoio gasolio con galleggiante livello e filtro di riempimento*
- *Valvola regolazione professionale a ripristino graduale della pressione*
- *Caldaia verticale con serpentina a doppia spirale*
- *Sistema elettronico di regolazione della temperatura, con basso pendolamento del valore impostato*
- **Certificazione PED 97/23/CE cat. II**
- *Bruciatore azionato da Flussostato*
- *Valvola di sicurezza*
- *Protezione termica della caldaia*
- *Kit comando controllo fiamma*
- *Uso professionale continuo*

- FW2 pump with 3 integral ceramic pistons and brass pump head
- Pompa FW2 con 3 pistoni in ceramica e testata in ottone

- Protective panels version (on request)
- Versione con pannelli protettivi (su richiesta)

- Water pumped from tank with filter and float, anti-scale dispenser with pump and 2.5 l capacity tank
- Aspirazione acqua da tanica con filtro e galleggiante, dosatore anticalcare con pompa e serbatoio da 2,5 lt

- High performance stainless steel boiler
- Caldaia ad elevato rendimento realizzata in acciaio inox



CAGE

TRAILER

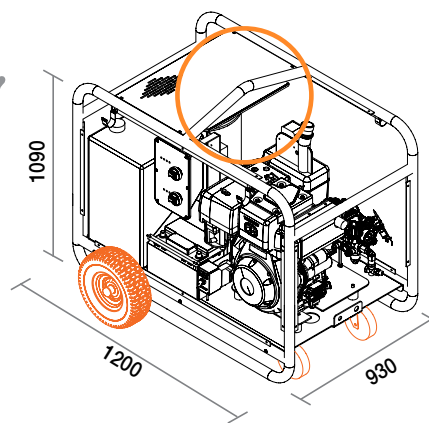
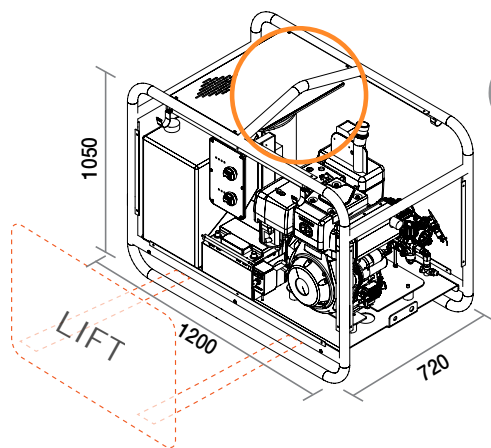

CODE CODICE	MODELS MODELLI	PUMP POMPA	Pressure		Flow l/h	Temperature °C	Power HP	Capacity l	Consumption kg/h	Weight kg	Dimensions (L x W x H) cm
			bar	MPa							
9058 0501 *	FDX Hot Cube 16/200 D Yanmar L 100 N	FW2	30 > 200	3 > 20	330 > 960	85 > 140	11	30	6,3	230	120x93x108
9058 0502 *	FDX Hot Cube 16/200 B Honda GX 390	FW2	30 > 200	3 > 20	330 > 960	85 > 140	13	30	6,3	200	120x93x108
9058 0503 *	FDX Hot Cube 21/160 D Yanmar L 100 N	FW2	30 > 160	3 > 16	560 > 1260	85 > 140	11	30	7,9	230	120x93x108
9058 0504 *	FDX Hot Cube 21/160 B Honda GX 390	FW2	30 > 160	3 > 16	560 > 1260	85 > 140	13	30	7,9	200	120x93x108

* Code for Trailer Version / Codice per Versione Trailer (Cage Version on request / Versione Cage su richiesta)
Protective panels kit available on request / Kit pannelli protettivi disponibile su richiesta

STANDARD ACCESSORIES › DOTAZIONE STANDARD

	GH 351 gun with Swivel (n.2 o-ring) Pistola GH 351 con Swivel (n.2 o-ring)		Double barrel lance, without nozzles Lancia a canna doppia senza ugelli
	Fan shape nozzle 25°, 1/4" MEG connection Ugello con getto a lama 25° attacco 1/4" MEG		10 m rubber delivery hose kit Kit tubo gomma mandata 10 m
	Brass inlet water filter Filtro aspirazione acqua in ottone		Detergent nozzle for double barrel lance, 1/4" MEG connection Ugello detergente per lancia canna doppia, attacco 1/4" MEG
	RPM deceleration kit Kit deceleratore di giri motore		Flame control kit Kit comando controllo fiamma

X-SPECIAL HOT WATER



HOT BOX



HOT WATER MOBILE GENERATOR GENERATORE MOBILE DI ACQUA CALDA



200 bar



350 bar > 500 bar



GENERAL FEATURES

- Hot water mobile generator up to 140°C for connection with Comet cold water high pressure cleaners
- Connection hose to pressure cleaner (R2 3/8" - 2 mt)
- Fuel tank with level float and fill up filter
- Steam or hot water operation
- Flow-switch controlled burner
- Professional safety valve
- Boiler thermal protection
- Flame control
- Electronic temperature setting system with constant water temperature
- "Machine switched on" indicator
- "Steam shutdown" indicator
- "Check burner" indicator



CARATTERISTICHE GENERALI

- Generatore mobile di acqua calda fino a 140°C per connessione con idropulitrici ad acqua fredda Comet
- Tubo di collegamento all'idropulitrice (R2 3/8" - 2 mt)
- Serbatoio gasolio, con galleggiante di livello e filtro di riempimento
- Funzionamento a vapore o acqua calda
- Bruciatore azionato da Flussostato
- Valvola di sicurezza professionale
- Protezione termica della caldaia
- Controllo fiamma
- Sistema elettronico di regolazione della temperatura, con basso pendolamento del valore impostato
- Spia "Macchina sottotensione"
- Spia "Stop vapore"
- Spia "Controllo bruciatore"

- Stainless steel cover panels (on 350-500 bar models)
- Pannelli di rivestimento in acciaio inox (su modelli 350-500 bar)

- High performance boiler
- Caldaia ad alte prestazioni

- Boiler kit can also be sold separately
- Kit Caldaia vendibile anche separatamente.



Cold water H.P. Cleaners
Idropultrici ad acqua fredda

Boiler HotBox 200 bar

Hot water H.P. Cleaners
Idropultrici ad acqua calda

- X-STAR
- KR 1100
- KL
- KSM
- KS
- KT
- STATIC
- ETM
- KA
- K250
- K COMPACT
- FDX 2
- FDX ELITE
- FDX WB



Cold water H.P. Cleaners
Idropultrici ad acqua fredda

Boiler HotBox 350 / 500 bar

Hot water H.P. Cleaners
Idropultrici ad acqua calda

- K PREMIUM
- FDX PRO - FDX 4
- PTO
- K STEEL SERIES
- K 1001 - 1251 - 1501(42/130) TS
- FDX XTREME
- K XTREME
- K 1501(18/350) TS



350 bar
500 bar



CODE CODICE	MODELS MODELLI	Electrical			Pressure		Flow (l/h)	Power (kW)	Temperature (°C)	Capacity (l)	Weight (kg/h)	Weight (kg)	Dimensions (L x W x H) cm
		Ph	V	Hz	bar	MPa							
9040 0004	Hot Box 15/200	1	230	50	200	20	900	0,25	90 > 140	18	5,7	90	95 x 62 x 85
9040 0010	Hot Box 25/350	1	230	50	350	35	1500	0,25	90 > 140	20	8,3	110	76 x 77 x 96
9040 0005	Hot Box 25/500	1	230	50	500	50	1500	0,25	90 > 140	20	8,3	120	76 x 77 x 96
9040 0011	Hot Box 25/350	-	12	-	350	35	1500	0,25	90 > 140	20	8,3	110	76 x 77 x 96
9040 0009	Hot Box 25/500	-	12	-	500	50	1500	0,25	90 > 140	20	8,3	120	76 x 77 x 96

On request, available 110-115V / 50-60 Hz, 200V / 50-60 Hz. / Disponibili su richiesta modelli a 110-115V / 50-60 Hz, 200V / 50-60 Hz.

STANDARD ACCESSORIES › DOTAZIONE STANDARD

200 bar	350 bar	500 bar
<p>R2 5/16" 2 mt connection high pressure rubber hose kit Kit tubo gomma alta pressione 2 mt per collegamento</p>	<p>R2 3/8" 2 mt connection high pressure rubber hose kit Kit tubo gomma alta pressione 2 mt per collegamento</p>	<p>R2 3/8" 1,5 mt connection high pressure rubber hose kit Kit tubo gomma alta pressione 1,5 mt per collegamento</p>



TRAPPER 2

130 GOLD



MTP KMR Gold



GENERAL FEATURES

- Comet electrical pump with three axial pistons arranged vertically with pump at the bottom and an all-metal construction without any plastic used for the structural components
- Head in brass (**Gold version only**) or aluminium
- Fuel tank with level indicator
- **EASY-START** device
- **TotalStop** device
- **Combustion head with transparent flame viewer**
- Delayed burner start
- Safety valve
- Boiler thermal protection
- 3 positions switch (stop - cold water - hot water)
- Motor thermal protection



CARATTERISTICHE GENERALI

- **Elettropompa Comet a tre pistoni assiali disposta in verticale con pompa in basso e costruzione interamente in metallo, senza materiale plastico nei componenti strutturali**
- Testa pompa in ottone (**solo versione Gold**) o alluminio
- Serbatoio gasolio con spia di livello
- Dispositivo **EASY-START**
- Dispositivo **TotalStop**
- **Testa di combustione con oblò controllo fiamma**
- Partenza ritardata del bruciatore
- Valvola di sicurezza
- Protezione termica della caldaia
- Interruttore a 3 posizioni (stop - acqua fredda - acqua calda)
- Protezione termica del motore
- **Uso domestico**

- Big rubber wheels
- Ruote di grandi dimensioni



- Small, powerful and easy to use
- Piccola, potente e semplice da usare



- Safety valve
- Valvola di sicurezza







- Combustion head with transparent flame viewer
- Testa di combustione con oblo controllo fiamma



CODE CODICE	MODELS MODELLI	MOTORPUMP MOTO Pompa												
			Ph	V	Hz	bar	MPa	l/h	kW	°C	l	kg/h	kg	(L x W x H) cm
9049 0502	TRAPPER 2 130 GOLD	KMR	1	230	50	130	13	450	2,2	90	25	2,45	55	68 x 50 x 80



STANDARD ACCESSORIES › DOTAZIONE STANDARD

 <p>Gun GH 251 with protection <i>Pistola GH 251 con protezione</i></p>	 <p>Bent lance with protection, without nozzle <i>Lancia angolata con protezione, senza ugello</i></p>
 <p>Fan shape nozzle 25°, 1/4" MEG connection <i>Ugello con getto a lama 25° attacco 1/4" MEG</i></p>	 <p>8 m rubber delivery hose kit <i>Kit tubo gomma mandata 8 m</i></p>
 <p>Foam lance <i>Lancia schiumogena</i></p>	



SCOUT



135 - 150



MTP KSR Gold



GENERAL FEATURES

- Comet electrical pump with three axial pistons arranged horizontally with pump at the bottom and an all-metal construction without any plastic used for the structural components and brass pump head
- Pressure gauge
- Built-in fuel and detergent tanks
- Direct low-pressure suction of water with detergent
- **EASY-START** device
- **TotalStop** device
- Delayed burner start
- Safety valve
- Amperometric motor protection
- **Temperature setting thermostat**



CARATTERISTICHE GENERALI

- *Elettropompa Comet a tre pistoni assiali disposta in orizzontale con pompa in basso e costruzione interamente in metallo, senza materiale plastico nei componenti strutturali e testata in ottone*
- *Manometro pressione*
- *Serbatoio gasolio e detergente integrati*
- *Aspirazione acqua diretta con detergente in bassa pressione*
- *Dispositivo **EASY-START***
- *Dispositivo **TotalStop***
- *Partenza ritardata del bruciatore*
- *Valvola di sicurezza*
- *Protezione amperometrica del motore*
- ***Termostato di regolazione temperatura***
- *Uso semiprofessionale*

- Big rubber wheels
- Ruote di grandi dimensioni

- Practical lance and gun storage
- Pratico alloggiamento della pistola e della lancia

- Hose reel with 10 m high-pressure hose (for EXTRA models only)
- Avvolgitubo con tubo alta pressione in gomma 10 m. (solo per modelli EXTRA)



CODE CODICE	MODELS MODELLI	MOTORPUMP MOTOPIOMPA													
			Ph	V	Hz	bar	MPa	l/h	kW	°C	l	kg/h	l	kg	(L x W x H) cm
9044 0001	SCOUT CLASSIC 150	KSR	1	230	50	150	15	540	2,7	90	15	3,11	4,5	85	89 x 50 x 82
9044 0003	SCOUT CLASSIC 135	KSR	1	230	50	135	13,5	600	2,7	90	15	3,11	4,5	85	89 x 50 x 82
9044 0002	SCOUT EXTRA 150	KSR	1	230	50	150	15	540	2,7	90	15	3,11	4,5	85	89 x 50 x 82
9044 0004	SCOUT EXTRA 135	KSR	1	230	50	135	13,5	600	2,7	90	15	3,11	4,5	85	89 x 50 x 82



STANDARD ACCESSORIES › DOTAZIONE STANDARD

CLASSIC		EXTRA	
	GH 251 gun with protection <i>Pistola GH 251 con protezione</i>		Bent lance with detergent head, without nozzle <i>Lancia angolata con testina detergente, senza ugello</i>
	Fan shape nozzle 15°, 1/4" MEG connection <i>Ugello con getto a lama 15° attacco 1/4" MEG</i>		10 m rubber delivery hose kit (on Hose Reel) <i>Kit tubo gomma mandata 10 m (su Avvolgitubo)</i>



KP

CLASSIC - EXTRA



AXR / GXR



GENERAL FEATURES

- 15-litres capacity fuel tank with level float and fill up filter
- Regulated low-pressure detergent suction
- 2 poles (2800 rpm) motor with thermal protection
- Delayed **TotalStop** (instantaneous on KP 3.10 model)
- **EASY-START** on single phase models
- Safety valve for boiler protection
- Boiler thermal protection
- Rotary On-Off switch
- Temperature setting thermostat
- Amperometric control (on three-phase models)
- Motor rotating control (on three-phase models)
- Phase control" indicator (on three-phase models)
- "No fuel" indicator



CARATTERISTICHE GENERALI

- *Serbatoio gasolio di capacità 15 litri, con galleggiante di livello e filtro di riempimento*
- *Aspirazione detergente in bassa pressione con regolazione*
- *Motore con protezione termica a 2 poli (2800 rpm)*
- ***TotalStop** temporizzato (istantaneo su modello KP 3.10)*
- ***EASY-START** su modelli monofase*
- *Valvola di sicurezza di protezione della caldaia*
- *Protezione termica della caldaia*
- *Interruttore rotativo per accensione*
- *Termostato di regolazione temperatura*
- *Controllo amperometrico (su modelli trifase)*
- *Controllo rotazione motore (su modelli trifase)*
- *Controllo fase (su modelli trifase)*
- *Spia "Mancanza gasolio"*
- *Uso semi-professionale gravoso*

- Hose reel with 15 m high-pressure rubber hose (Extra versions only)
- *Avvolgitubo con 15 mt tubo gomma alta pressione (solo versioni Extra)*



- Gun with pressure regulator (optional)
- *Pistola con regolatore di pressione (optional)*



- Front bumper
- *Paraurti anteriore*



- Closeable handles for transport operation
- *Maniglie richiudibili per operazioni di trasporto*



- Access to all inner parts, casing comes off in one piece
- *Accesso a tutte le parti interne rimuovendo la Carenatura in unico pezzo*



- Rear bumper
- *Paraurti posteriore*



CODE CODICE	MODELS MODELLI	MOTORPUMP MOTO Pompa	Ph		V		Hz		bar		MPa		l/h		HP		kW		kW		°C		l		kg/h		l		kg		(L x W x H) cm	
			1	3	230	400	50	140	180	14	18	600	720	3,0	5,0	2,2	3,7	2,9	4,8	110	15	3,5	4,2	3,5	100	105	94 x 62 x 84	104 x 62 x 84				
9061 0001	KP Classic 3.10 10/140 M	GXR	1	230	50	140	14	600	3,0	2,2	2,9	110	15	3,5	3,5	95	94 x 62 x 84															
9061 0002	KP Classic 5.12 12/180 T	AXR	3	400	50	180	18	720	5,0	3,7	4,8	110	15	4,2	3,5	100	94 x 62 x 84															
9061 0003	KP Extra 3.10 10/140 M	GXR	1	230	50	140	14	600	3,0	2,2	2,9	110	15	3,5	3,5	100	104 x 62 x 84															
9061 0004	KP Extra 5.12 12/180 T	AXR	3	400	50	180	18	720	5,0	3,7	4,8	110	15	4,2	3,5	105	104 x 62 x 84															



STANDARD ACCESSORIES › DOTAZIONE STANDARD

CLASSIC		EXTRA	
	GH 251 gun <i>Pistola GH 251</i>		Bent lance with detergent head, without nozzle <i>Lancia angolata con testina detergente, senza ugello</i>
	Fan shape nozzle 15°, 1/4" MEG connection <i>Ugello con getto a lama 15° attacco 1/4" MEG</i>		Hose reel with 15 m rubber delivery hose <i>Avvolgitubo con 15 m tubo gomma mandata</i>
	10 m rubber delivery hose kit <i>Kit tubo gomma mandata 10 m</i>		Hose reel with 15 m rubber delivery hose <i>Avvolgitubo con 15 m tubo gomma mandata</i>



KP PRO

CLASSIC - EXTRA



LW-K



GENERAL FEATURES

- 15-litres capacity fuel tank with level float and fill up filter
- Regulated low-pressure detergent suction
- 4 poles (1400 rpm) motor with thermal protection
- Delayed **TotalStop**
- **EASY-START** on single phase models
- Safety valve for boiler protection
- Boiler thermal protection
- Rotary On-Off switch
- Temperature setting thermostat
- Amperometric control (on three-phase models)
- Motor rotating control (on three-phase models)
- Phase control" indicator (on three-phase models)
- "No fuel" indicator



CARATTERISTICHE GENERALI

- *Serbatoio gasolio di capacità 15 litri, con galleggiante di livello e filtro di riempimento*
- *Aspirazione detergente in bassa pressione con regolazione*
- *Motore con protezione termica a 4 poli (1400 rpm)*
- **TotalStop** temporizzato
- **EASY-START** su modelli monofase
- *Valvola di sicurezza di protezione della caldaia*
- *Protezione termica della caldaia*
- *Interruttore rotativo per accensione*
- *Termostato di regolazione temperatura*
- *Controllo amperometrico (su modelli trifase)*
- *Controllo rotazione motore (su modelli trifase)*
- *Controllo fase (su modelli trifase)*
- *Spia "Mancanza gasolio"*
- *Uso professionale*

- Hose reel with 15 m high-pressure rubber hose (Extra versions only)
- *Avvolgitubo con 15 mt tubo gomma alta pressione (solo versioni Extra)*



- Gun with pressure regulator
- *Pistola con regolatore di pressione*



- Front bumper
- *Paraurti anteriore*



- Closeable handles for transport operation
- *Maniglie richiudibili per operazioni di trasporto*



- Access to all inner parts, casing comes off in one piece
- *Accesso a tutte le parti interne rimuovendo la Carenatura in unico pezzo*



- Rear bumper
- *Paraurti posteriore*



CODE CODICE	MODELS MODELLI	MOTORPUMP MOTO Pompa	Ph		V		Hz		bar		MPa		l/h		HP		kW		kW		°C		l		kg/h		l		kg		(L x W x H) cm	
			1	3	1	3	1	3	1	3	1	3	1	3	1	3	1	3	1	3	1	3	1	3	1	3	1	3	1	3	1	3
9061 0101	KP PRO Classic 3.10 10/150 M	LW-K	1	230	50	150	15	600	3,0	2,2	3,0	110	15	3,5	3,5	95	94 x 62 x 84															
9061 0102	KP PRO Classic 5.12 12/200 T	LW-K	3	400	50	200	20	720	5,5	4,0	5,3	110	15	4,2	3,5	100	94 x 62 x 84															
9061 0103	KP PRO Extra 3.10 10/150 M	LW-K	1	230	50	150	15	600	3,0	2,2	3,0	110	15	3,5	3,5	100	104 x 62 x 84															
9061 0104	KP PRO Extra 5.12 12/200 T	LW-K	3	400	50	200	20	720	5,5	4,0	5,3	110	15	4,2	3,5	105	104 x 62 x 84															



STANDARD ACCESSORIES › DOTAZIONE STANDARD

CLASSIC		EXTRA	
	GH 281 gun with Swivel and pressure regulator <i>Pistola GH 281 con Swivel e regolatore pressione</i>		
	Bent lance with detergent head, without nozzle <i>Lancia angolata con testina detergente, senza ugello</i>		
	Fan shape nozzle 15°, 1/4" MEG connection <i>Ugello con getto a lama 15° attacco 1/4" MEG</i>		
	10 m rubber delivery hose kit <i>Kit tubo gomma mandata 10 m</i>		Hose reel with 15 m rubber delivery hose <i>Avvolgitubo con 15 m tubo gomma mandata</i>



KM CLASSIC



LW-K



ZW



FW2



- 2 swivel wheels in addition to the two fixed wheels
- 2 ruote girevoli in aggiunta alle due ruote fisse



- Practical and safe lance supports
- Pratici e sicuri supporti lancia



GENERAL FEATURES

- 18-litre capacity fuel tank with level float and fill up filter
- Regulated high-pressure detergent suction
(only models with water tank)
- Regulated low-pressure detergent suction
(only models without water tank)
- 4-pole motor (1400 rpm) with Comet LW-K, ZW and FW2 with water tank and integrated valve on LW-K
- FW2 pump with flanged valve on 8.15 models
- Delayed **TotalStop**
- **EASY-START** on single-phase models
- Delayed burner start
- Professional safety valve
- Boiler thermal protection
- Rotary On-Off switch
- Contactor and motor protection with amperometric control
- Temperature setting thermostat
- "No fuel" indicator
- "Machine switched on" indicator
- "Phase control" indicator



CARATTERISTICHE GENERALI

- Serbatoio gasolio di capacità 18 litri, con galleggiante di livello e filtro di riempimento
- Aspirazione detergente in alta pressione con regolazione
(solo modelli con tanica acqua)
- Aspirazione detergente in bassa pressione con regolazione
(solo modelli senza tanica acqua)
- Motore a 4 poli (1400 giri/min) con pompe Comet LW-K, ZW e FW2 con tanica acqua e valvola inglobata su LW-K
- Pompa FW2 con valvola flangiata su modelli 8.15
- **TotalStop** temporizzato
- **EASY-START** su modelli monofase
- Partenza ritardata del bruciatore
- Valvola di sicurezza professionale
- Protezione termica della caldaia
- Interruttore Rotativo per accensione
- Teleruttore e protezione del motore con controllo amperometrico
- Termostato di regolazione temperatura
- Spia "Mancanza gasolio"
- Spia "Macchina sottotensione"
- Spia "Controllo fase"
- Uso professionale

- Separate boiler fan unit
- Gruppo ventilazione caldaia indipendente

- Water tank with anti-scale device (only on models with water tank)
- Vaschetta acqua con dispositivo e serbatoio anticalcare (solo su modelli con vaschetta acqua)

- Door for adjusting pump pressure and for inspecting and cleaning water filter
- Sportello per regolazione della pressione pompa e per ispezione e pulizia del filtro acqua

- Hose reel with 15 m high-pressure rubber hose (on request)
- Avvolgitubo con 15 mt tubo gomma alta pressione (su richiesta)



CODE CODICE	MODELLI MODELLI	PUMP POMPA	Ph		V		Hz		bar		MPa		l/h		HP		kW		kW		°C		l		kg/h		l		kg		(L x W x H) cm	
			Ph	V	Hz	bar	MPa	l/h	HP	kW	kW	°C	l	kg/h	l	kg	(L x W x H) cm															
Without water tank and anti-scale tank - Senza vaschetta acqua e cisterna anticalcare																																
9060 0301	KM Classic 3.11 11/120	LW-K	1	230	50	120	12	660	3,0	2,2	2,9	110	18	3,5	3,5	105	95 x 62 x 85															
9060 0306	KM Classic 5.13 13/180	ZW	3	400	50	180	18	780	5,5	4,0	4,9	110	18	4,6	3,5	110	95 x 62 x 85															
9060 0307	KM Classic 5.15 15/160	ZW	3	400	50	160	16	900	5,5	4,0	5,0	110	18	5,5	3,5	110	95 x 62 x 85															
9060 0305	KM Classic 8.15 15/200	FW2	3	400	50	200	20	900	7,5	5,5	6,5	110	18	5,7	3,5	125	95 x 62 x 85															
With water tank and anti-scale tank - Con vaschetta acqua e cisterna anticalcare																																
9060 0351	KM Classic 3.11 11/120	ZW	1	230	50	120	12	660	3,0	2,2	2,9	110	18	3,5	3,5	110	95 x 62 x 85															
9060 0352	KM Classic 5.13 13/180	ZW	3	400	50	180	18	780	5,5	4,0	4,9	110	18	4,6	3,5	115	95 x 62 x 85															
9060 0353	KM Classic 5.15 15/160	ZW	3	400	50	160	16	900	5,5	4,0	5,0	110	18	5,5	3,5	115	95 x 62 x 85															
9060 0355	KM Classic 8.15 15/200	FW2	3	400	50	200	20	900	7,5	5,5	6,5	110	18	5,7	3,5	128	95 x 62 x 85															

STANDARD ACCESSORIES › DOTAZIONE STANDARD

Without Water Tank and Anti-scale Tank Senza Vaschetta Acqua e Cisterna Anticalcare		With Water Tank and Anti-scale Tank Con Vaschetta Acqua e Cisterna Anticalcare	
<p>GH 301 gun with Swivel Pistola GH 301 con Swivel</p>		<p>Bent lance with detergent head, without nozzle Lancia angolata con testina detergente, senza ugello</p>	
<p>Bent lance with nozzle holder, without nozzle Lancia angolata con testa portaugello, senza ugello</p>		<p>Fan shape nozzle 25°, 1/4" MEG connection Ugello con getto a lama 25° attacco 1/4" MEG</p>	
<p>10 m rubber delivery hose kit Kit tubo gomma mandata 10 m</p>			



KM EXTRA

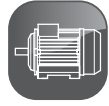

PED
97 / 23 / CE
cat. II



- 2 swivel wheels in addition to the two fixed wheels
- 2 ruote girevoli in aggiunta alle due ruote fisse



- Practical and safe lance supports
- Pratici e sicuri supporti lancia



GENERAL FEATURES

- 18-litre capacity fuel tank with level float and fill up filter
- High pressure detergent suction with adjustment of the quantity from an inside tank, possibility of using an external detergent tank
- Water suction from a tank with an integrated and readily serviceable suction cartridge filter
- Anti-scale device with pump and tank (2.5 l)
- Professional 4-pole motor (1400 rpm) with Comet ZW pumps and professional unloader bolt-on valve
- FW2 pump on 8.15 model
- Timed **TotalStop**
- **General stop (when the machine is not used for a long time)**
- **EASY-START** on 1-230 models
- Steam operation
- Flow-switch controlled burner
- Professional safety valve
- Boiler thermal protection
- Electronic temperature setting system with constant water temperature
- **PED 97/23/CE cat. II certification**
- Delayed burner start



CARATTERISTICHE GENERALI

- Serbatoio gasolio di capacità 18 litri, con galleggiante di livello e filtro di riempimento
- Aspirazione detergente in alta pressione con regolazione della quantità da serbatoio interno, possibilità di aspirare da tanica esterna
- Aspirazione acqua da cisterna integrata con filtro aspirazione a cartuccia ispezionabile
- Dispositivo anticalcare con pompa e serbatoio (2,5 lt)
- Motore a 4 poli professionale (1400 giri/min) con pompe Comet ZW e valvola regolazione pressione professionale flangiata
- Pompa FW2 su modello 8.15
- **TotalStop** temporizzato
- **Stop generale (in caso di prolungata inattività)**
- **EASY-START** su modelli 1-230
- Funzionamento a vapore
- Bruciatore azionato da Flussostato
- Valvola di sicurezza professionale
- Protezione termica della caldaia
- Sistema elettronico di regolazione della temperatura, con basso pendolamento del valore impostato
- **Certificazione PED 97/23/CE cat. II**
- Partenza ritardata del bruciatore
- Uso professionale

- Separate boiler fan unit
- Gruppo ventilazione caldaia indipendente

- Water tank with anti-scale device (only on models with water tank)
- Vaschetta acqua con dispositivo e serbatoio anticalcare (solo su modelli con vaschetta acqua)

- Professional control panel
- Quadro comandi professionale





- Hose reel with 15 m high-pressure rubber hose (on request)
- Avvolgitubo con 15 mt tubo gomma alta pressione (su richiesta)



CODE CODICE	MODELS MODELLI	PUMP POMPA	Ph		V		Hz		bar		MPa		l/h		HP		kW		kW		°C		l		kg/h		l		kg		(L x W x H) cm	
			Ph	V	Hz	bar	MPa	l/h	HP	kW	kW	°C	l	kg/h	l	kg	(L x W x H) cm															
9060 0501	KM Extra 3.11 11/120	ZW	1	230	50	30 > 120	3 > 12	330 > 660	3,0	2,2	2,9	85 > 140	18	3,5	3,5	110	95x62x85															
9060 0502	KM Extra 5.13 13/180	ZW	3	400	50	30 > 180	3 > 18	330 > 780	5,5	4,0	5,0	85 > 140	18	4,6	3,5	115	95x62x85															
9060 0503	KM Extra 5.15 15/160	ZW	3	400	50	30 > 160	3 > 16	400 > 900	5,5	4,0	5,0	85 > 140	18	5,5	3,5	115	95x62x85															
9060 0505	KM Extra 8.15 15/200	FW2	3	400	50	30 > 200	3 > 20	330 > 900	7,5	5,5	6,5	85 > 140	18	5,7	3,5	128	95x62x85															



STANDARD ACCESSORIES › DOTAZIONE STANDARD

 <p>GH 351 gun with Swivel (n. 2 o-ring) <i>Pistola GH 351 con Swivel (n. 2 o-ring)</i></p>	 <p>Bent lance, with nozzle holder, without nozzle <i>Lancia angolata, testina portaugello, senza ugello</i></p>
 <p>Fan shape nozzle 25°, 1/4" MEG connection <i>Ugello con getto a lama 25° attacco 1/4" MEG</i></p>	 <p>10 m rubber delivery hose kit <i>Kit tubo gomma mandata 10 m</i></p>
 <p>Flame control kit <i>Kit comando controllo fiamma</i></p>	



KE PREMIUM PLUS



PREMIUM



RW Premium



GENERAL FEATURES

- Fuel tank with level floater and fill up filter
- Regulated high-pressure detergent suction
(only models with water tank)
- Regulated low-pressure detergent suction
(only models without water tank)
- Readily serviceable suction filter
- Professional 4-pole motor (1400 rpm) with double bearing
- Professional pressure unloader valve with external bypass
- Self Priming pumps
- Timed **TotalStop**
- Pressure gauge
- Safety valve
- Boiler thermal protection
- Delayed burner start
- Low voltage control panel
- Contactor
- Motor protected with a thermal relay
- Rotary On-Off switch
- **Temperature setting thermostat**
- "No fuel" indicator
- "Machine switched on" indicator



CARATTERISTICHE GENERALI

- *Serbatoio gasolio con galleggiante livello e filtro di riempimento*
- *Aspirazione detergente in alta pressione con regolazione*
(solo modelli con tanica acqua)
- *Aspirazione detergente in bassa pressione con regolazione*
(solo modelli senza tanica acqua)
- Filtro aspirazione ispezionabile
- Motore a 4 poli (1400 giri/min) professionale con doppio cuscinetto
- *Valvola regolazione pressione professionale con by-pass esterno*
- *Pompe autoadescenti*
- **TotalStop** temporizzato
- *Manometro pressione*
- *Valvola di sicurezza*
- *Protezione termica della caldaia*
- *Partenza ritardata del bruciatore*
- *Quadro comandi in bassa tensione*
- *Teleruttore*
- *Protezione del motore con relè termico*
- *Interruttore Rotativo per accensione*
- **Termostato di regolazione temperatura**
- *Spia "Mancanza gasolio"*
- *Spia "Macchina sottotensione"*
- *Uso professionale*

- Big solid wheels (260 mm ø)
- Ruote piene di grandi dimensioni (ø 260 mm)

- Highly professional motor pump unit with patented coupling between motor with double bearing and the Comet RW Premium pump with 3 integral ceramic pistons and brass pump head. External bypass valve
- Gruppo motopompa altamente professionale con accoppiamento brevettato, tra motore con doppio cuscinetto e pompa Comet RW Premium con 3 pistoni in ceramica integrale con testata in ottone. Valvola by-pass esterno

- Separate boiler fan unit
- Gruppo ventilazione caldaia indipendente



CODE CODICE	MODELS MODELLI	PUMP POMPA	Ph		V		Hz		bar		MPa		l/h		HP		kW		°C		I		kg/h		I		kg		(L x W x H) cm	
Without water tank - Senza vaschetta acqua																														
9033 0901	KE Premium plus 15/200	RW Premium	3	400	50	200	20	900	8,0	5,9	7,0	110	13	6,4	13	130	103 x 71 x 86													
With water tank - Con vaschetta acqua																														
9033 0902	KE Premium plus 15/200	RW Premium	3	400	50	200	20	900	8,0	5,9	7,0	110	13	6,4	13	130	103 x 71 x 86													
With water tank and anti-scale tank (2,5 lt) - Con vaschetta acqua e cisterna anticalcare (2,5 lt)																														
9033 0906	KE Premium plus 15/200	RW Premium	3	400	50	200	20	900	8,0	5,9	7,0	110	13	6,4	13	130	103 x 71 x 86													

STANDARD ACCESSORIES › DOTAZIONE STANDARD

Without Water Tank Senza Vaschetta Acqua	With Water Tank Con Vaschetta Acqua
	GH 351 gun with Swivel (n. 2 o-ring) <i>Pistola GH 351 con Swivel (n. 2 o-ring)</i>
	Bent lance with nozzle holder, without nozzle <i>Lancia angolata con testa portaugello, senza ugello</i>
	Fan shape nozzle 25°, 1/4" MEG connection <i>Ugello con getto a lama 25° attacco 1/4" MEG</i>
	10 m rubber delivery hose kit <i>Kit tubo gomma mandata 10 m</i>



KF CLASSIC



PREMIUM



RW Premium



GENERAL FEATURES

- Fuel tank with level floater and fill up filter
- Regulated high-pressure detergent suction (only models with water tank)
- Regulated low-pressure detergent suction (only models without water tank)
- Readily serviceable suction filter
- Professional 4-pole motor (1400 rpm)
- Professional pressure unloader valve
- Timed **TotalStop**
- Pressure gauge
- Flow-switch controlled burner
- Safety valve
- Boiler thermal protection
- Delayed burner start
- Low voltage control panel
- Contactor
- Motor protected with thermal relay
- Rotary On-Off switch
- **Temperature setting thermostat**
- "No fuel" indicator
- "Machine switched on" indicator



CARATTERISTICHE GENERALI

- Serbatoio gasolio con galleggiante livello e filtro di riempimento
- Aspirazione detergente in alta pressione con regolazione (solo modelli con tanica acqua)
- Aspirazione detergente in bassa pressione con regolazione (solo modelli senza tanica acqua)
- Filtro aspirazione ispezionabile
- Motore a 4 poli professionale (1400 giri/min)
- Valvola regolazione pressione professionale
- **TotalStop** temporizzato
- Manometro pressione
- Bruciatore azionato da Flussostato
- Valvola di sicurezza
- Protezione termica della caldaia
- Partenza ritardata del bruciatore
- Quadro comandi in bassa tensione
- Teleruttore
- Protezione del motore con relè termico
- Interruttore Rotativo per accensione
- **Termostato di regolazione temperatura**
- Spia "Mancanza gasolio"
- Spia "Macchina sottotensione"
- Uso professionale intensivo

- Door for inspecting and cleaning the water filter
- Sportello ispezione e pulizia filtro acqua



- Separate boiler fan unit
- Gruppo ventilazione caldaia indipendente



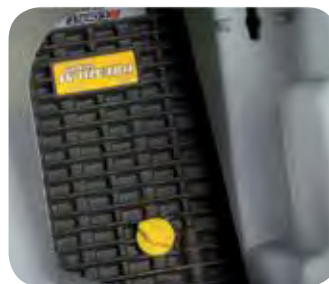

- Glove compartment with handy access to check pump oil level
- Vano portaoggetti con pratico accesso controllo livello olio pompa



CODE CODICE	MODELS MODELLI	PUMP POMPA	Ph		V		Hz		bar		MPa		l/h		HP		kW		kW		°C		l		kg/h		l		kg		(L x W x H) cm	
			Ph	V	Hz	bar	MPa	l/h	HP	kW	kW	°C	l	kg/h	l	kg	(L x W x H) cm															
Without water tank - Senza vaschetta acqua																																
9051 0301	KF Classic 6.15	RW Premium	3	400	50	160	16	900	6,0	4,4	5,8	110	19	6,4	16	152	132 x 82 x 96															
9051 0302	KF Classic 8.15	RW Premium	3	400	50	200	20	900	8,0	5,9	7,0	110	19	6,4	16	152	132 x 82 x 96															
With water tank - Con vaschetta acqua																																
9051 0309	KF Classic 6.15	RW Premium	3	400	50	160	16	900	6,0	4,4	5,8	110	19	6,4	16	152	132 x 82 x 96															
9051 0308	KF Classic 8.15	RW Premium	3	400	50	200	20	900	8,0	5,9	7,0	110	19	6,4	16	152	132 x 82 x 96															
9051 0306	KF Classic 9.18	RW Premium	3	400	50	200	20	1080	9,0	6,6	7,6	110	19	6,4	16	158	132 x 82 x 96															
9051 0307	KF Classic 9.21	RW Premium	3	400	50	170	17	1260	9,0	6,6	7,6	110	19	6,4	16	158	132 x 82 x 96															
9051 0951	KF Classic 10.18	RW Premium	3	400	50	220	22	1080	10,0	7,3	9,8	110	19	8,0	16	165	132 x 82 x 96															
9051 0952	KF Classic 10.21	RW Premium	3	400	50	210	21	1260	10,0	7,3	10,3	110	19	8,0	16	165	132 x 82 x 96															



STANDARD ACCESSORIES › DOTAZIONE STANDARD

Without Water Tank Senza Vaschetta Acqua		With Water Tank Con Vaschetta Acqua	
 <p>GH 351 gun with Swivel (n. 2 o-ring) Pistola GH 351 con Swivel (n. 2 o-ring)</p>			
 <p>Bent lance with detergent head, without nozzle Lancia angolata con testina detergente, senza ugello</p>		 <p>Bent lance with nozzle holder, without nozzle Lancia angolata con testa portaugello, senza ugello</p>	
 <p>Fan shape nozzle 25°, 1/4\" data-bbox="468 846 741 868"/> </p>			
 <p>10 m rubber delivery hose kit Kit tubo gomma mandata 10 m</p>			



KF EXTRA



PREMIUM

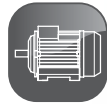

PED
97 / 23 / CE
cat. II



RW Premium



GENERAL FEATURES

- Fuel tank with level floater and fill up filter
- Regulated high-pressure detergent suction
- Readily serviceable suction filter
- Big solid wheels (300 mm ø)
- **Anti-scale device with pump and tank (2.5 l)**
- Professional 4-pole motor (1400 rpm)
- Professional pressure-release unloader valve
- Timed **TotalStop**
- General stop (when the machine is not used for a long time)
- Double coil vertical boiler
- **Stainless steel outer casing**
- Electronic temperature setting system with constant water temperature
- **PED 97/23/CE cat. II certification**
- Flow-switch controlled burner
- Safety valve
- Boiler thermal protection
- Delayed burner start



CARATTERISTICHE GENERALI

- *Serbatoio gasolio con galleggiante livello e filtro di riempimento*
- *Aspirazione detergente in alta pressione con regolazione*
- *Filtro aspirazione ispezionabile*
- *Ruote piene di grandi dimensioni (ø 300 mm)*
- ***Dispositivo anticalcare con pompa e serbatoio (2,5 lt)***
- *Motore a 4 poli professionale (1400 giri/min)*
- *Valvola regolazione pressione professionale a rilascio pressione*
- ***TotalStop*** temporizzato
- *Stop generale (in caso di prolungata inattività)*
- *Caldaia verticale con serpentina a doppia spirale*
- ***Corpo esterno caldaia in acciaio inox***
- *Sistema elettronico di regolazione della temperatura con basso pendolamento del valore impostato*
- ***Certificazione PED 97/23/CE cat. II***
- *Bruciatore azionato da Flussostato*
- *Valvola di sicurezza*
- *Protezione termica della caldaia*
- *Partenza ritardata del bruciatore*
- *Uso professionale intensivo*

- Door for inspecting and cleaning the water filter
- Sportello ispezione e pulizia filtro acqua

- Separate boiler fan unit
- Gruppo ventilazione caldaia indipendente

- Glove compartment with handy access to check pump oil level
- Vano portaoggetti con pratico accesso controllo livello olio pompa

- Professional control panel
- Quadro comandi professionale



CONTROL PANEL

- Low voltage controls
- Contactor
- Motor protected with a thermal relay
- Rotary On-Off switch
- Electronic temperature setting
- "No fuel" indicator
- "Machine switched on" indicator
- "General Stop" indicator
- "Motor thermal cut-out triggered" indicator
- "Microleaks alarm" indicator
- "Steam shutdown" indicator
- "Check burner" indicator



QUADRO COMANDI

- Comandi in bassa tensione
- Teleruttore
- Protezione del motore con relè termico
- Interruttore Rotativo per accensione
- Regolazione elettronica temperatura
- Spia "Mancanza gasolio"
- Spia "Macchina sottotensione"
- Spia "Stop Generale"
- Spia "Intervento termico motore"
- Spia "Allarme microperdite"
- Spia "Stop vapore"
- Spia "Controllo bruciatore"

CODE CODICE	MODELS MODELLI	PUMP POMPA	Electrical		Pressure		Flow	Power		Temperature	Capacity	Weight	Dimensions				
			Ph	V	Hz	bar		MPa	I/h					HP	kW		
9051 0701	KF Extra 6.15	RW Premium	3	400	50	30 > 160	3 > 16	400 > 900	6,0	4,4	5,8	85 > 140	19	6,4	16	152	132x82x96
9051 0703	KF Extra 8.15	RW Premium	3	400	50	30 > 200	3 > 20	370 > 900	8,0	5,9	7,0	85 > 140	19	6,4	16	154	132x82x96
9051 0704	KF Extra 9.18	RW Premium	3	400	50	30 > 200	3 > 20	450 > 1080	9,0	6,6	7,6	85 > 140	19	6,4	16	160	132x82x96
9051 0702	KF Extra 9.21	RW Premium	3	400	50	30 > 170	3 > 17	550 > 1260	9,0	6,6	7,6	85 > 140	19	6,4	16	160	132x82x96
9051 0901	KF Extra 10.18	RW Premium	3	400	50	30 > 220	3 > 22	400 > 1080	10,0	7,3	9,8	85 > 140	19	8,0	16	165	132x82x96
9051 0902	KF Extra 10.21	RW Premium	3	400	50	30 > 210	3 > 21	540 > 1260	10,0	7,3	10,3	85 > 140	19	8,0	16	165	132x82x96



STANDARD ACCESSORIES › DOTAZIONE STANDARD

<p>GH 351 gun with Swivel (n. 2 o-ring) <i>Pistola GH 351 con Swivel (n. 2 o-ring)</i></p>	<p>Bent lance, with nozzle holder, without nozzle <i>Lancia angolata, testina portaugello, senza ugello</i></p>
<p>Fan shape nozzle 25°, 1/4" MEG connection <i>Ugello con getto a lama 25° attacco 1/4" MEG</i></p>	<p>10 m rubber delivery hose kit <i>Kit tubo gomma mandata 10 m</i></p>
<p>Flame control kit <i>Kit comando controllo fiamma</i></p>	

VACUUM CLEANERS • *ASPIRATORI*

VACUUM CLEANERS • ASPIRATORI

Cartridge filters • Filtro a cartuccia

- Suitable for dust with a grain size bigger than 5 µm. This does not include dust produced by tools used for honing, grinding or sanding, etc., which are usually fine and are smaller than 5 µm.
- *Adatti per polveri con granulometrie superiori ai 5 µm, sono escluse le polveri generate da utensili per levigazione, smerigliatura, carteggio, ecc., in quanto solitamente generano polveri (fini) inferiori ai 5 µm.*



Hepa and BIA cartridge filter Filtro a cartuccia Hepa e BIA

- When working with tools for honing, grinding or sanding, etc., Law Decree 626/94 requires the use of Hepa and BIA filters which are capable of retaining dust particles as small as 0.3 µm (equivalent to a filtration efficiency of 99.97%). As a result, a standard filter is not enough.
- *La norma 626/94 impone, nelle lavorazioni con utensili per levigazione, smerigliatura, carteggio, ecc., l'utilizzo dei filtri Hepa e BIA, in quanto sono in grado di filtrare particelle di polvere fino a 0,3 µm (equivalente ad una percentuale di filtrazione del 99,97%), per questo motivo il filtro standard non basta*



Polyester filter with ring and filter cage Filtro in poliestere con anello e tendifiltro

- It can be used with the cartridge filter installed or in place of it. By increasing the number of filtration stages the primary filter works more efficiently and requires less frequent cleaning. In this case the polyester fabric filter with ring serves as the first level filter. Using the polyester filter together with the cartridge filter brings the retention capacity of the filter down from 5 µm to 3 µm
- *Può essere utilizzato con il filtro a cartuccia montato o in alternativa ad esso. Aumentando gli stadi di filtrazione il filtro primario lavora meglio e necessita di essere ripulito con minor frequenza in questo modo il panno con anello assume il ruolo di filtro primo livello. Utilizzando il filtro poliestere, insieme al filtro a cartuccia si abbassa il valore da 5 µm fino a 3 µm.*



Nylon filter with ring and filter cage Filtro in nylon con anello e tendifiltro

- This must always be used with the cartridge filter installed. With certain applications we recommend using it together with the BIA and Hepa cartridge filter rather than the standard one (car body shops, carpentry, marble works, etc.).
- *Deve sempre essere utilizzato con il filtro a cartuccia montato, in particolari settori è consigliabile impiegarlo con il filtro cartuccia Hepa e BIA anziché quello standard (carrozzerie, falegnamerie, marmmerie, ecc.).*



Sponge filter • Filtro a mousse

- This must be fitted on the float mount (after removing the cartridge filter) every time the unit is to be used to aspirate liquids.
- *Deve essere montato sul portagalleggiante ogni volta che si devono aspirare liquidi (dopo aver rimosso il filtro a cartuccia).*



CAUTION

Never suck flammable, explosive, toxic or carcinogenic liquids.

ATTENZIONE

Evitare assolutamente l'aspirazione di liquidi infiammabili, esplosivi, tossici e cancerogeni.

PROFESSIONAL SERIES WITH 1 MOTOR - SERIE PROFESSIONALE A 1 MOTORE

AS 20-P

Wet& Dry



GENERAL FEATURES - CARATTERISTICHE GENERALI

- Compact, designed to take up little room, they are particularly powerful, light, flexible, simple, easy to handle and use.
- *Di dimensioni contenute, studiati per essere poco ingombranti, sono particolarmente potenti, leggeri, versatili, semplici, maneggevoli e di facile uso.*

AS 21-X

Wet& Dry



GENERAL FEATURES - CARATTERISTICHE GENERALI

- Compact, designed to take up little room, they are particularly powerful, light, flexible, simple, easy to handle and use.
- *Di dimensioni contenute, studiati per essere poco ingombranti, sono particolarmente potenti, leggeri, versatili, semplici, maneggevoli e di facile uso.*

AS 31-X

Wet& Dry



GENERAL FEATURES - CARATTERISTICHE GENERALI

- Compact, designed to take up little room, they are particularly powerful, light, flexible, simple, easy to handle and use.
- *Di dimensioni contenute, studiati per essere poco ingombranti, sono particolarmente potenti, leggeri, versatili, semplici, maneggevoli e di facile uso.*

AS 35 PRO-P



GENERAL FEATURES - CARATTERISTICHE GENERALI

- Complete with a wide range of accessories. Powerful, versatile, easy to handle and particularly suitable for medium-sized areas.
- *Corredato da un'ampia gamma di accessori. Potente, versatile, maneggevole e particolarmente adatto alle medie superfici.*

CARATTERISTICHE TECNICHE - TECHNICAL SPECIFICATIONS		AS 20-P W&D	AS 21-X W&D	AS 31-X W&D	AS 35 PRO-P
CODICE - CODE		9350 0045	9350 0050	9350 0051	9350 0052
Peso • Weight	kg	7,6	7,8	8,5	12,6
Tensione Nominale (Frequenza) • Nominal Voltage (Frequency)	V (Hz)	230 (50-60)	230 (50-60)	230 (50-60)	230 (50-60)
Potenza Motore • Motor Power	W	1250	1250	1250	1250
Capacità nominale contenitore detriti • Nominal capacity of dirt container	lt	21	21	30	36
Contenitore realizzato in • Container made in		PP	ACCIAIO STEEL	ACCIAIO STEEL	PP
Depressione max • Maximum Vacuum power	kPa	19	19	19	22,5
Portata aria efficace • Airflow rate	m³/h	209	209	209	190
Lunghezza cavo alimentazione • Length of the power cable	m	3	3	3	8,5
Tipo motore (Grado di protezione) • Type of motor (Protection level)		by-pass (IPX4)	by-pass (IPX4)	by-pass (IPX4)	by-pass (IPX4)
Classe di isolamento • Insulation class		□	□	□	□
Numero Motori • Motors Number		1	1	1	1
Stadi Motori • Motors Stages		1	1	1	2
SISTEMA FILTRANTE - FILTERING SYSTEM		AS 20-P W&D	AS 21-X W&D	AS 31-X W&D	AS 35 PRO-P
		CODICE - CODE	CODICE - CODE	CODICE - CODE	CODICE - CODE
Sacco in carta • Paper bag		3050 0011	3050 0011	3050 0013	3050 0013
Sacco in poliestere • Polyester bag		3050 0012	3050 0012	3050 0014	3050 0014
Filtro a cartuccia poliestere • Polyester cartridge filter		1002 0249	1002 0249	1002 0249	1002 0248
Filtro in poliestere con anello • Polyester filter with ring		1002 0246	1002 0246	1002 0246	1002 0247
Filtro in poliestere con anello e tendifiltro • Polyester filter with ring and filter stretcher					
Cappuccio liquidi • Hood for liquids		1002 0166	1002 0166	1002 0166	1002 0166

PROFESSIONAL SERIES WITH 1 OR 2 MOTORS - SERIE PROFESSIONALE A 1 O 2 MOTORI

AS 50 PRO-X



AS 70 PRO-X



AS 70 PRO-B2-X



▶ GENERAL FEATURES - CARATTERISTICHE GENERALI

- Powerful, designed and built for demanding jobs. Perfect for big areas such as: workshops, labs, showrooms, hotels, etc. The stainless steel container is suitable for problem-free suction of corrosive liquids.
- *Potenti apparecchi, progettati e costruiti per lavori impegnativi. Adatti alle grandi superfici: officine, laboratori, aree espositive, hotels, etc. Il contenitore in acciaio inox è idoneo per aspirare senza problemi le sostanze liquide corrosive.*

AS 37 VIBRA

FOR DUST ONLY
DO NOT USE TO
VACUUM LIQUIDS

SOLO PER POLVERI
DA NON UTILIZZARE
PER ASPIRARE LIQUIDI



▶ GENERAL FEATURES - CARATTERISTICHE GENERALI

- Suitable for the suction of processing debris generally. Power-driven tool connection with microprocessor for automatic stop and start. The filter is cleaned automatically thanks to the Intelligent Cleaning Filter vibrating system. A pair of electromechanical vibrators start working only when the filter is dirty.
- *Idoneo nell'aspirazione di residui di lavorazione in genere. Attacco elettroutensili dotato di microprocessore che consente l'avviamento e lo stop automatico. La pulizia del filtro è automatica grazie al sistema vibrante Intelligent Cleaning Filter. Una coppia di vibratori elettromeccanici si attiva solo quando il filtro è sporco.*

CARATTERISTICHE TECNICHE - TECHNICAL SPECIFICATIONS		AS 50 PRO-X	AS 70 PRO-X	AS 70 PRO-B2-X	AS 37 VIBRA
CODICE - CODE		9350 0053	9350 0054	9350 0055	9350 0032
Peso • Weight	kg	13,5	21	23	12,8
Tensione Nominale (Frequenza) • Nominal Voltage (Frequency)	V (Hz)	230 (50-60)	230 (50-60)	230 (50-60)	230 (50-60)
Potenza Motore • Motor Power	W	1400	1400	2600	1400
Capacità nominale contenitore detriti • Nominal capacity of dirt container	lt	50	77	77	37
Contenitore realizzato in • Container made in		ACCIAIO INOX STAINLESS STEEL	ACCIAIO INOX STAINLESS STEEL	ACCIAIO INOX STAINLESS STEEL	PP
Depressione max • Maximum Vacuum power	kPa	24	24	24	24
Portata aria efficace • Airflow rate	m³/h	215	215	340	215
Potenza max disp. alla presa per elettroutensile • Max outlet power for power-driven tools	W				2000
Lunghezza cavo alimentazione • Length of the power cable	m	8,5	8,5	8,5	8,5
Tipo motore (Grado di protezione) • Motor type (Protection level)		by-pass (IPX4)	by-pass (IPX4)	by-pass (IPX4)	by-pass (IPX4)
Classe di isolamento • Insulation class		□	□	□	(I)
Numero Motori • Motors Number		1	1	2	1
Stadi Motori • Motors Stages		2	2	2	2
SISTEMA FILTRANTE - FILTERING SYSTEM		AS 50 PRO-X	AS 70 PRO-X	AS 70 PRO-B2-X	AS 37 VIBRA
Sacco in carta • Paper bag		3050 0007	3050 0007	3050 0007	3050 0007
Sacco in poliestere • Polyester bag		3050 0015	3050 0015	3050 0015	
Filtro a cartuccia poliestere • Polyester cartridge filter		1002 0248	1002 0186	1002 0186	
Filtro a cartuccia Hepa • Hepa cartridge filter			1002 0169	1002 0169	1002 0192
Filtro in poliestere con anello • Polyester filter with ring		1002 0247	1002 0184	1002 0184	
Filtro in poliestere con anello e tendifiltro • Polyester filter with ring and filter stretcher			1002 0167	1002 0167	1002 0247
Cappuccio liquidi • Hood for liquids		1002 0166	1002 0166	1002 0166	1002 0166

AS 75 F2

▶ GENERAL FEATURES - CARATTERISTICHE GENERALI

- Professional vacuum cleaner and liquid cleaner with trolley, handles on the sides, emptying kit to facilitate emptying of the plastic container. Ideal for family businesses, industries and for cleaning large areas.
- *Aspirapolvere ed aspiraliquidi professionale equipaggiato di carrello con maniglie laterali e con kit di svuotamento per facilitare lo svuotamento del fusto in plastica. Ideale per aziende artigiane, industrie e pulizie di grandi superfici.*



AS 77 B2

▶ GENERAL FEATURES - CARATTERISTICHE GENERALI

- Professional vacuum cleaner and liquid cleaner with handle and tilting trolley to make transporting and emptying the plastic container easier. Ideal for family businesses, industries and for cleaning large areas.
- *Aspirapolvere ed aspiraliquidi professionale equipaggiato di maniglione e carrello basculante, per facilitare gli spostamenti e lo svuotamento del fusto in plastica, ideale per aziende artigiane, industrie e pulizie di grandi superfici.*



AS 78 B3



CARATTERISTICHE TECNICHE - TECHNICAL SPECIFICATIONS		AS 75 F2	AS 77 B2	AS 78 B3
CODICE - CODE		9350 0025	9350 0026	9350 0027
Peso • Weight	kg	21	25	27
Tensione Nominale (Frequenza) • Nominal Voltage (Frequency)	V (Hz)	230 (50-60)	230 (50-60)	230 (50-60)
Potenza Motore • Motor Power	W	2600	2600	3300
N. motori • No. of motors		2	2	3
Capacità nominale contenitore detriti • Nominal capacity of dirt container	lt	77	77	77
Contenitore realizzato in • Container made in		PP	PP	PP
Depressione max • Maximum Vacuum power	kPa	22	24	22
Portata aria efficace • Airflow rate	m ³ /h	340	430	510
Lunghezza cavo alimentazione • Length of the power cable	m	8,5	8,5	8,5
Tipo motore (Grado di protezione) • Motor type (Protection level)		by-pass (IPX4)	by-pass (IPX4)	by-pass (IPX4)
Classe di isolamento • Insulation class		□	□	□
Stadi Motori • Motors Stages		2	2	2
SISTEMA FILTRANTE - FILTERING SYSTEM		AS 75 F2	AS 77 B2	AS 78 B3
Filtro a cartuccia poliestere • Polyester cartridge filter		1002 0186	1002 0186	1002 0186
Filtro-mousse per aspirare sostanze liquide • Sponge filter for vacuuming up liquids		1002 0166	1002 0166	1002 0166
Filtro a cartuccia Hepa • Hepa cartridge filter		1002 0169	1002 0169	1002 0169
Filtro in poliestere con anello e tendifiltro • Polyester filter with ring and filter stretcher		1002 0167	1002 0167	1002 0167
Sacchetto di carta • Paper bag		3050 0007	3050 0007	3050 0007
Filtro in poliestere con anello • Polyester filter with ring		1002 0184	1002 0184	1002 0184

PROFESSIONAL SERIES WITH 2 OR 3 MOTORS - SERIE PROFESSIONALE A 2 O 3 MOTORI

AS 76-2

GENERAL FEATURES - CARATTERISTICHE GENERALI

- Extractor model (liquid cleaner) for cleaning armchairs, carpets and rugs, using the right fitting to supply the detergent. A 20-litre capacity tank guarantees good autonomy (water or water mixed with detergent). Use of the detergent is essential while vacuuming up dust is possible with the optional dust kit. Equipped with handle and tilting trolley.
- *Modello estrattore (aspiraliquidi) utilizzabile per la pulizia di poltrone, moquette e tappeti, utilizzando la bocchetta adatta per erogare il detergente, grazie ad un serbatoio da 20 L garantisce una buona autonomia (acqua o acqua mista con detergente). È fondamentale l'utilizzo del detergente, mentre l'aspirazione delle polveri è consentita con il kit polveri, optional. Equipaggiato di maniglione e carrello basculante.*



AS 81-B3 Metaloil

GENERAL FEATURES - CARATTERISTICHE GENERALI

- For vacuuming specific materials such as metal swarfs, wood and glass residues not to mention oils, lubricants and everything else deriving from mechanical manufacturing waste. The suction filter which has a high filtering surface is protected against the direct impact of materials by a cyclone effect barrier.
- *Per l'aspirazione di materiali particolari quali i trucioli di metallo, residui di legno e vetro, nonché oli, lubrificanti e quant'altro derivante dagli scarti della produzione meccanica. Il filtro di aspirazione ad elevata superficie filtrante, è protetto dall'urto diretto dei materiali per mezzo di una barriera che favorisce l'effetto ciclone.*



- "Cyclone" filter protection
- Proteggi filtro "ciclone"

CARATTERISTICHE TECNICHE - TECHNICAL SPECIFICATIONS		AS 76-2	AS 81 METALOIL
CODICE - CODE		9350 0029	9350 0033
Peso • Weight	kg	31	30
Tensione Nominale (Frequenza) • Nominal Voltage (Frequency)	V (Hz)	230 (50-60)	230 (50-60)
Potenza Motore • Motor Power	W	3600	3600
N. motori • No. of motors		2	3
Capacità nominale contenitore detriti • Nominal capacity of dirt container	lt	77	77
Contenitore realizzato in • Container made in Stainless Steel		PP	PP
Depressione max • Maximum Vacuum power	kPa	24	24
Portata aria efficace • Airflow rate	m³/h	460	645
Lunghezza cavo alimentazione • Length of the power cable	m	8,5	8,5
Tipo motore (Grado di protezione) • Motor type (Protection level)		by-pass (IPX4)	by-pass (IPX4)
Classe di isolamento • Insulation class		□	□
Stadi Motori • Motors Stages		2	2
SISTEMA FILTRANTE - FILTERING SYSTEM		AS 76-2	AS 81 METALOIL
		CODICE - CODE	CODICE - CODE
Filtro a cartuccia poliestere • Polyester cartridge filter			1002 0165
Filtro-mousse per aspirare sostanze liquide • Sponge filter for vacuuming up liquids		1002 0166	1002 0166
Proteggi filtro "ciclone" • "Cyclone" filter protection			2416 0147
Filtro a cartuccia Hepa • Hepa cartridge filter		1002 0169	
Filtro in poliestere con anello e tendifiltro • Polyester filter with ring and filter stretcher		1002 0167	1002 0167
Sacchetto di carta • Paper bag		3050 0007	
Filtro in poliestere con anello • Polyester filter with ring		1002 0184	1002 0184

NEBULISATION EQUIPMENT · APPARECCHI PER LA NEBULIZZAZIONE

SPRAY

- Equipment for nebulising low density liquids, detergents and disinfectants.
- Apparecchi per la nebulizzazione di liquidi detergenti e disinfettanti a bassa densità.

 24 Lt
INOX

24 Lt



50 Lt



GENERAL FEATURES

- Filled with liquid and loaded with air at 6 bar, they work automatically without having to be connected continuously to compressed air.

CARATTERISTICHE GENERALI

- Riempiti di liquido e caricati d'aria a 6 bar, funzionano autonomamente senza bisogno del collegamento continuo all'aria compressa.

	SP 24 SPRAY	SX 24 SPRAY INOX	SP 50 SPRAY
Codice / Code	9360 0001	9360 0003	9360 0005
Capacità / Capacity	24 Lt	24 Lt	50 Lt
Serbatoio / Tank	Acciaio Verniciato Painted Steel	Acciaio INOX Stainless Steel	Acciaio Verniciato Painted Steel
Valvola di Sicurezza Safety Valve	8 bar -MPa 0,8	8 bar - MPa 0,8	8 bar - MPa 0,8
Kit pistola-lancia Gun Lance kit	600 mm	600 mm INOX	900 mm
Tubo / Hose	6 m - RILSAN	6 m - RILSAN	6 m - RILSAN
Ugelli / Nozzles	No. 1 (Ottone - Brass)	No. 1 (Ottone - Brass)	No. 1 (Ottone - Brass)
Manometro / Gauge	SI / YES	SI / YES	SI / YES
Indicatore Livello Level viewer	SI / YES	SI / YES	SI / YES

NEBULISATION EQUIPMENT - APPARECCHI PER LA NEBULIZZAZIONE

FOAM

- Equipment for nebulising liquids and detergents with a solution foaming device.
- *Apparecchi per la nebulizzazione di liquidi detergenti con dispositivo soluzione schiumogena.*

24 Lt
INOX

24 Lt



50 Lt

 GENERAL FEATURES

- Filled with liquid and loaded with air at 6 bar they need to be connected continuously to compressed air.

 CARATTERISTICHE GENERALI

- Riempi di liquido e caricati d'aria a 6 bar, necessitano del collegamento continuo all'aria compressa.

	SP 24 FOAM	SX 24 FOAM INOX	SP 50 FOAM
Codice / Code	9360 0002	9360 0004	9360 0006
Capacità / Capacity	24 Lt	24 Lt	50 Lt
Serbatoio / Tank	Acciaio Verniciato Painted Steel	Acciaio INOX Stainless Steel	Acciaio Verniciato Painted Steel
Valvola di Sicurezza Safety Valve	8 bar - MPa 0,8	8 bar - MPa 0,8	8 bar - MPa 0,8
Kit pistola-lancia Gun Lance kit	600 mm	600 mm INOX	900 mm
Tubo / Hose	10 m - PVC	10 m - PVC	10 m - PVC
Ugelli / Nozzles	No. 4 (Ottone - Brass)	No. 4 (Ottone - Brass)	No. 4 (Ottone - Brass)
Manometro / Gauge	SI / YES	SI / YES	SI / YES
Indicatore Livello Level viewer	SI / YES	SI / YES	SI / YES

DETERGENTI › SOLO PER IL MERCATO ITALIANO - ONLY FOR ITALIAN MARKET

HAND NEUTRO

 Autovetture
e veicoli
industriali

Motori



Edilizia

 Macchinari e
attrezzature
industriali

 Statue, fontane,
restauro

CARATTERISTICHE GENERALI

- *Uso Hobbystico*
- *Hand Neutro è un detergente neutro, costituito da una miscela di tensioattivi anionici ad alto potere lavante.*
- *È adatto alle pulizie manuali di tutte le superfici lavabili, in particolare facilita l'eliminazione di ogni tipo di sporco, anche il più tenace, dalle superfici delle autovetture.*
- *Negli impianti di lavaggio automatico, viene usato per un ulteriore ripasso manuale delle zone più sporche.*

CARATTERISTICHE TECNICHE

- *Hand neutro si usa solitamente diluito in acqua in rapporto da 1:100 a 2:100 (1-2%) a seconda dello sporco. Quando utilizzato con idropulitrice, diluire al 4:100 a 5:100 (4-5%).*
- PH 6.0
- Biodegradabilità 100%
- Confezioni:
It 1x12 0609 0007
It 5x4 0609 0008
It 10 0609 0009

BASIC AUTO

 Autovetture
e veicoli
industriali

Motori



Edilizia

 Veicoli e
attrezzature
agricole

 Macchinari e
attrezzature
industriali

CARATTERISTICHE GENERALI

- *Basic Auto è un detergente liquido alcalino, specifico per il lavaggio degli autoveicoli con idropultrici ad acqua calda o acqua fredda.*
- *Ottimo per la pulizia di macchinari ed attrezzature agricole ed industriali.*

CARATTERISTICHE TECNICHE

- *Basic Auto si usa solitamente diluito in acqua in rapporto da 3:100 a 5:100 (3-5%) per utilizzo manuale o con nebulizzatori.*
- *Quando utilizzato con idropultrice, diluire al 5:100 a 6:100 (5-6%).*
- PH 6.0
- Biodegradabilità 90%
- Confezioni:
It 1x12 0609 0010
It 5x4 0609 0011
It 10 0609 0012

ECO MOTO

 Autovetture
e veicoli
industriali

Motori



Edilizia

 Veicoli e
attrezzature
agricole

Moto

 Statue, fontane,
restauro

CARATTERISTICHE GENERALI

- *Eco Moto è un detergente universale idoneo per la pulizia di ogni tipo di superficie, specifico per il lavaggio di motori, automezzi e attrezzature con particolari di alluminio e di leghe leggere.*
- *Ottimo per la pulizia di moto e biciclette, per la pulizia di piazzali e pavimenti industriali, idoneo al lavaggio delle tende.*

CARATTERISTICHE TECNICHE

- *Eco Moto si usa solitamente diluito in acqua in rapporto da 2:100 a 20:100 (2-20%) 2-4% per superfici dure con sporco grasso non penetrato, 2-3% per motocicli e biciclette con telai in alluminio, 5-6% per cisterne ed autocarri con particolari in alluminio, 10-20% per motori di auto, camion e barche.*
- *Quando utilizzato con idropultrice, diluire del 10-20%.*
- PH 12.0
- Biodegradabilità 90%
- Confezioni:
It 1x12 0609 0013
It 5x4 0609 0014
It 10 0609 0015

TENAX FORTE

 Autovetture
e veicoli
industriali

 Veicoli e
attrezzature
agricole

CARATTERISTICHE GENERALI

- *Uso Professionale*
- *Tenax Forte è un detergente molto energetico a base alcalina, autolucidante, specifico per il lavaggio con idropultrice ad acqua calda o ad acqua fredda di carrozzerie d'autovetture, veicoli industriali e macchine agricole.*

CARATTERISTICHE TECNICHE

- *Tenax Forte si usa solitamente diluito in acqua in rapporto da 1:100 a 2:100 (1-2%) se utilizzato con nebulizzatori. Quando utilizzato con idropultrice, diluire al 5:100 a 6:100 (5-6%).*
- PH 13.0
- Biodegradabilità 90%
- Confezioni:
It 5x4 0609 0016
It 10 0609 0017

DETERGENTI › SOLO PER IL MERCATO ITALIANO - ONLY FOR ITALIAN MARKET

EDIL DET



Edilizia

Statue, fontane,
restauroAttrezzature
sanitariAttrezzature
industria
alimentare

CARATTERISTICHE GENERALI

- *Uso Professionale*
- *Edil Det è un detergente disincrostante specifico per l'industria alimentare e l'industria edilizia.*
- *Particolarmente indicato per togliere lo smog da muretti e da statue, per togliere il calcare dalle piscine e dalle fontane, per pulire i sanitari.*
- *Non dà luogo ad esalazioni.*

CARATTERISTICHE TECNICHE

- *Edil Det si usa solitamente diluito in acqua in rapporto da 5:100 a 10:100 (5-10%).*
- *Quando utilizzato con idropulitrice, diluire al 10:100 (10%).*
- *PH 2.5*
- *Biodegradabilità 90%*
- *Confezioni:*
It 5x4 0609 0018
It 10 0609 0019

TESSIL DET

Per bidoni aspiratutto con lancia lavamoquette



CARATTERISTICHE GENERALI

- *Tessil Det è un detergente industriale costituito da una miscela di sostanze attive a bassa schiumosità.*
- *Particolarmente efficace per la pulizia di poltrone, tappeti, moquette, tappezzeria, interni auto.*
- *Lascia un delicato e gradevole odore di profumo fresco.*

CARATTERISTICHE TECNICHE

- *Tessil Det si usa solitamente diluito in acqua in rapporto da 10:100 (10%).*
- *PH 12.7*
- *Biodegradabilità 90%*
- *Confezioni:*
It 5x1 0609 0026

SPECIAL PRODUCTS FOR H.P. CLEANERS - PRODOTTI SPECIALI PER IDROPULTRICI AD ACQUA CALDA

ACID SER disincrostante



CARATTERISTICHE GENERALI

- *Acid Ser è un disincrostante per eliminare i depositi calcarei nelle serpentine delle idropultrici, senza danneggiare il materiale a contatto con il liquido.*

CARATTERISTICHE TECNICHE

- *Acid Ser si usa diluito con acqua al 10%.*
- *Lasciare agire il prodotto per 12-16 ore nella*
- *PH < 1*
- *Confezioni:*
It 10 0060 0002

NO KAL anticalcare



CARATTERISTICHE GENERALI

- *No Kal è un anticalcare liquido che previene la formazione di calcare nelle serpentine delle idropultrici.*

CARATTERISTICHE TECNICHE

- *No Kal si usa nella tanica anticalcare delle idropultrici.*
- *PH < 7*
- *Confezioni:*
It 5 0060 0006
It 10 0060 0005
It 20 0060 0003

Sabbia



CARATTERISTICHE GENERALI

- *Sabbia silicea.*

CARATTERISTICHE TECNICHE

- *Sabbia silicea grani 0,6 - 1,2*
- *Confezioni:*
Kg 25 3048 0001

Bicarbonato di Sodio



CARATTERISTICHE GENERALI

- *Bicarbonato di Sodio per lance sabbianti.*

CARATTERISTICHE TECNICHE

















- *Bicarbonato di Sodio per lance sabbianti.*
- *Confezioni:*
Kg 25 3048 0003

BLUE SERIES COMMERCIAL / STATIC

				X STAR		KR	KL						KS		
				CLASSIC	EXTRA	1100	CLASSIC 1300	EXTRA 1300	CLASSIC 1400	EXTRA 1400	CLASSIC 1600	EXTRA 1600	PLUS 1680	CLASSIC 1700	EXTRA 1700
Accessories • Accessori															
Gun kit with guard • Kit pistola con protezione															
	Gun • Pistola		2410 0097	•	•		•	•	•	•	•	•	•		
	GC 251	G1/4M	2410 0118											•	•
	GC 251	G3/8M	2410 0120												
	GH 281 + pressure unloader valve	G1/4M	2410 0225				*	*	*	*	*	*	*	*	*
	<i>GH 281 +regolatore pressione</i>	G3/8M	2410 0222												
	Gun • Pistola		2410 0170			•									
	GH 301 + Swivel	G3/8M	2410 0182												
Lance kit without nozzle • Kit lancia senza ugello															
	Adjustable jet	mm 500	3301 0935												
	<i>Getto regolabile</i>														
	Securfix		3301 1118	•	•		•	•	•	•	•	•			
Lance kit with nozzle • Kit lancia con ugello															
	Diritta • Straight	ø 1,05	3301 1355										•		
	Angolata • Bent	ø 1,1	3301 1054												
	Angolata • Bent	ø 1,2	3301 0927												
	Angolata • Bent	ø 1,15	3301 0933												
	Angolata • Bent	ø 1,3	3301 1016												
	Angolata • Bent	ø 1,25	3301 1064											•	•
	Diritta • Straight		3301 1209			•									
Lance nozzle • Ugello lancia															
		028	3400 0709												
		025	3400 0506												
		033	3400 0712												
		030	3400 0416												
		028	3400 0508												
		037	3400 0715												
		033	3400 0510											•	•
		043	3400 0717												
		045	3400 0698												
		035	3400 0512												
		050	3400 0704												
Lance hose kit with rotating nozzle • Kit tubo lancia con ugello rotante															
	Straight • Diritta	035	3301 0781												
	Straight • Diritta	040	3301 0777												
	Straight • Diritta	050	3301 0893												
	Straight • Diritta	045	3301 0782												
	Straight • Diritta	025	3301 1091										•		
	Bent • Angolata	028	3301 1151												
	Bent • Angolata	033	3301 1052											*	•
	Bent • Angolata	037	3301 1024												
	Straight • Diritta		3301 1211			•									
Securfix nozzle head kit • Kit testina ugello Securfix															
		ø 1,0	3217 0250				•	•							
		ø 1,05	3217 0252	•	•			•	•						
		ø 1,15	3217 0256							•	•				
Securfix rotating nozzle head kit • Kit testina ugello rotante Securfix															
		022	3217 0246	*	•		*	•	*	•					
		028	3217 0248							*	•				
Foam lance kit • Kit lancia schiumogena															
			3301 0766												
			3301 0795										•	*	*
			3301 1061	•	•		•	•	•	•	•	•			
			3301 1127												
			3301 1213			•									

KT						KA					STATIC					K 250 STATIC								
CLASSIC 1750	EXTRA 1750	CLASSIC 1800	EXTRA 1800	CLASSIC 1900	EXTRA 1900	CLASSIC 2800	CLASSIC 3000	CLASSIC 3200	CLASSIC 5000	EXCEL 2800	EXCEL 3000	EXCEL 3200	EXCEL 4000	EXCEL 5000	CLASSIC 1700	EXTRA 1700	EXTRA 1700 I.A.	CLASSIC 1900	EXTRA 1900	10/150M	12/130M	15/170T		
•	•	•	•	•	•					•	•	•	•	•	•	•	•	•	•					
*	*	*	*	*	*					•	•	•	•	•	*	*	*	*	*					
						*	*	*	*	*	*	*	*	*								*	*	*
																						•	•	•
						*	•	•	•	*	•	•	•	•								•	•	•
•	•			•	•	•				•					•	•	•							
•	•	•	•			•		•		•		•			•	•	•					•		
				•	•		•				•							•	•				•	
									*					*								*		*
	•												*	*										*
		•				*		*		*		*			*	•	•							
			•		•	*	*			*	*							*	•					
*	*	*	*	*	*	*	*	*	*	*	*	*	*	*								*	*	*
															•	•	•	•	•					

BLUE SERIES COMMERCIAL / STATIC

			X STAR		KR	KL						KS		
			CLASSIC	EXTRA	1100	CLASSIC 1300	EXTRA 1300	CLASSIC 1400	EXTRA 1400	CLASSIC 1600	EXTRA 1600	PLUS 1680	CLASSIC 1700	EXTRA 1700
Accessories • Accessori														
Rotating brush • Idrospazzola rotante														
	l/min 8 ÷ 11	1413 0029												
		1413 0032	*	●		*	●	*	●	*	●	●	*	*
		1413 0033	*	*		*	*	*	*	*	*	*	*	*
Professional solar panels washing kit • Kit professionale lavaggio pannelli solari														
	G3/8 M	1603 0101	*	*	*	*	*	*	*	*	*	*	*	*
Drain cleaning kit • Kit sonda spurgatubi														
	m 8	3045 0028	*	*		*	*	*	*	*	*	*	*	*
	m 15	3045 0029											*	*
	m 25 6 ÷ 9 l/min	3045 0034												
	m 25 10÷15 l/min	3045 0041												
Floor cleaning lance kit • Kit tubo lancia pavimenti														
	SC 155	3301 0710											*	*
	SC 147	3301 1407	*	*	*	*	*	*	*	*	*	*	*	*
Double barrel lance kit • Kit lancia canna doppia														
	mm 700	3301 0941												
	+ nozzle + ugello ø4 2540	3400 0391												
Sand/Soda blasting kit • Kit lancia sabbiate/bicarbonato														
	ø 1,2	3301 0771												
	ø 1,4	3301 0772												
		3301 0801								*	*	*	*	*
Delivery hose kit • Kit tubo mandata														
	m 15 R1-1/4"	3208 0971												
	m 8 R1-1/4"	3208 1012												
	m 8 R1-1/4"	3208 1300										●		
	m 10 R1-1/4"	3208 1050												
	m 10 R1-1/4"	3301 0689												
	m 8 R1-1/4"	3301 0769												
	m 8 R1-1/4"	3301 0767					●		●		●		●	
	m 10 R1-1/4"	3301 0794												●
	m 6 R1-1/4"	3301 1035	●	●		●		●		●				
	m 20 R1-1/4"	3301 1102												
	m 12 R1-5/16"	3301 1134												
	m 20 R1-1/4"	3301 1185												
	m 5 R1-1/4"	3301 1207			●									
Delivery hose kit • Kit tubo mandata speciale														
	m 8 R1-1/4"	3301 0612												
	m 8 R1-1/4"	3301 0785											*	
	m 8 R1-5/16"	3301 1218												
Delivery hose extension kit • Kit prolunga tubo mandata														
	m 8	3301 0788	*	*		*	*	*	*	*	*		*	
	m 8 R1-1/4"	3301 0811												*
	m 8 R1-1/4"	3301 1312										*		
	m 4	3301 1028	*	*		*	*	*	*	*	*			
	m 10 R1-1/4"	3301 1124												

KT						KA					STATIC					K 250 STATIC								
CLASSIC 1750	EXTRA 1750	CLASSIC 1800	EXTRA 1800	CLASSIC 1900	EXTRA 1900	CLASSIC 2800	CLASSIC 3000	CLASSIC 3200	CLASSIC 5000	EXCEL 2800	EXCEL 3000	EXCEL 3200	EXCEL 4000	EXCEL 5000	CLASSIC 1700	EXTRA 1700	EXTRA 1700 T.A.	CLASSIC 1900	EXTRA 1900	10/150 M	12/130 M	15/170 T		
						*	*	*	*	*	*	*	*	*							*	*	*	
*	●	*	●	*	●										*	*	*	*	*					
*	*	*	*	*	*										*	●	●	*	●					
*	*	*	*	*	*	*	*	*	*	*	*	*	*	*	*	*	*	*	*	*	*	*	*	
*	*	*	*	*	*										*	*	*	*	*					
*	*	*	*	*	*	*									*	*	*	*	*					
		*	*	*	*					*											*	*	*	
*	*	*	*	*	*	*	*	*	*	*	*	*	*	*	*	*	*	*	*	*	*	*	*	
*	*	*	*	*	*										*	*	*	*	*					
						*	*	*	*	*	*	*	*	*							*	*	*	
						*	*	*	*	*	*	*	*	*							*	*	*	
*	*	*	*	*	*	*	*	*	*	*	*	*	*	*	*	*	*	*	*	*	*	*	*	
						●	●	●	●	●	●	●	●	●								●	●	●
						*	*	*	*						●			●			*	*	*	
	●		●																					
				●																				
*	*	*	*	*	*																			
															*	*	*	*	*					

BLUE SERIES COMMERCIAL / STATIC

				X STAR		KR	KL						KS		
				CLASSIC	EXTRA	1100	CLASSIC 1300	EXTRA 1300	CLASSIC 1400	EXTRA 1400	CLASSIC 1600	EXTRA 1600	PLUS 1680	CLASSIC 1700	EXTRA 1700
Accessories • Accessori															
Hose reel kit • Kit avvolgitubo girevole															
	m 10	R1-1/4"	7002 0265											*	
	m 15	R1-1/4"	7002 0330												
	m 20	R1-5/16"	7002 0332												
	m 12	R1-1/4"	7002 0292												
Spiral suction hose kit • Kit tubo aspirazione spiralato															
	m 8		3299 0019												
Suction hose kit with quick coupling • Kit attacco rapido aspirazione acqua															
			5002 0021	*	*		*	*	*	*	*	*	*	*	*
Suction hose with quick coupling • Attacco rapido aspirazione acqua															
			2803 3387												
Suction hose kit with quick coupling kit • Kit tubo aspirazione con kit attacco rapido															
			3208 0783	*	*									*	*
Ejector kit • Kit eiettore															
			3410 0381												
Regulated detergent suction cap kit • Kit tappo aspirazione regolazione detergente															
			3312 0014												
Back-flow preventer kit BA 10 • Kit disconnettore idrico BA 10															
	G3/4M G3/4M		0608 0049	*	*	*	*	*	*	*	*	*	*	*	*
	Garden hose quick couplers Kit raccordi attacco rapido	G3/4F G3/4F	5002 0024	*	*	*	*	*	*	*	*	*	*	*	*
Suction coupling kit • Kit raccordo aspirazione															
			2803 3429			●									
Water filter • Filtro acqua															
			1002 0231			●									
Accessory rack • Supporto accessori															
			3002 0688												
Hose cleaning guide kit • Kit guida tubo															
			5018 0084												
Sludge pump kit • Kit lancia aspirafango															
	030		3410 0373											*	*
	050		3410 0375												







KT						KA					STATIC					K 250 STATIC							
CLASSIC 1750	EXTRA 1750	CLASSIC 1800	EXTRA 1800	CLASSIC 1900	EXTRA 1900	CLASSIC 2800	CLASSIC 3000	CLASSIC 3200	CLASSIC 5000	EXCEL 2800	EXCEL 3000	EXCEL 3200	EXCEL 4000	EXCEL 5000	CLASSIC 1700	EXTRA 1700	EXTRA 1700 TA.	CLASSIC 1900	EXTRA 1900	10/150 M	12/130 M	15/170 T	
																					*	*	*
																					*	*	*
*		*		*																			
						*	*	*	*	*	*	*	*	*							*	*	*
*	*	*	*	*	*										*	*	*	*	*				
						*	*	*	*	*	*	*	*	*							*	*	*
*	*	*	*	*	*																		
																					●	●	●
*	*	*	*	*	*																		
*	*	*	*	*	*	*	*	*	*	*	*	*	*	*	*	*	*	*	*	*	*	*	*
*	*	*	*	*	*	*	*	*	*	*	*	*	*	*	*	*	*	*	*	*	*	*	*
															●	●	●	●	●				
															*	*	*	*	*				
*	*	*	*	*	*	*		*	*	*	*	*	*	*	*	*	*	*	*	*	*	*	*
							*				*		*	*							*		*

BLUE SERIES PROFESSIONAL / K STEEL

			K 250										K PREMIUM							
Accessories • Accessori			EXTRA 10/150	CLASSIC 10/150	EXTRA 12/130	CLASSIC 12/130	EXTRA 11/160	CLASSIC 11/160	EXTRA 13/190	CLASSIC 13/190	EXTRA 15/170	CLASSIC 15/170	EXTRA 11/210	CLASSIC 11/210	6.13 T	6.15 T	8.15 T	8.21 T	9.15 T	9.21 T
Gun kit with guard • Kit pistola con protezione																				
	GH 351 + swivel		2410 0114																	
	GC 251		2410 0120	●		●		●		●		●								
	GC 251 + prolunga + swivel		2410 0174																	
	GH 281 + pressure unloader valve GH 281 + regolatore pressione	G 3/8 M	2410 0222	*	*	*	*	*	*	*	*	*	*	*	*	*	*	*	*	*
	GH 301 + Swivel		2410 0182	●	*	●	*	●	*	●	*	●	*							
	GH 351 + revolving lance GH 351 + lancia girevole		2410 0124											*	*	*	*	*	*	
	GH 351 + fixed lance GH 351 + lancia fissa		2410 0126											*	*	*	*	*	*	
	GH351 INOX + Swivel		2410 0184																	
	RL51 + Swivel + ball quick coupler RL51 + Swivel + attacco rapido a sfere		2410 0194																	
	RL56 + Swivel + ball quick coupler RL56 + Swivel + attacco rapido a sfere		2410 0201																	
	GH 501 con attacchi rapidi GH 501 with quick couplers		2410 0195																	
Bent lance hose kit, detergent head, without nozzle • Kit tubo lancia angolata testina detergente senza ugello																				
		mm 500	3301 0935	●	●	●	●	●	●	●	●	●	●	●	●	●	●	●	●	●
		mm 700	3301 0976												●	●	●	●	●	●
		mm 900 INOX	3301 1225																	
		mm 500 INOX	3301 1244																	
		mm 1200 INOX	3301 1245																	
Straight stainless steel lance with ball quick coupler, without nozzles • Lancia dritta inox con attacco rapido a sfere, senza ugelli																				
			3301 1362																	
Double barrel lance kit • Kit tubo lancia canna doppia																				
		mm 700	3301 0941	*	*	*	*	*	*	*	*	*	*	*	*	*	*	*	*	*
		mm 700 INOX	3301 1222																	
		mm 800	3301 1323																	
	+det. nozzle + ugello det.	ø 4	3400 0391	*	*	*	*	*	*	*	*	*	*	*	*	*	*	*	*	*
Stainless-steel lance with rotating nozzle with quick coupler M24x1,5 (600 bar) • Lancia inox con ugello rotante con attacchi rapidi M24x1,5 (600 bar)																				
		030 inox	3301 1324																	
		035 inox	3301 1332																	
		040 inox	3301 1325																	
		050 inox	3301 1327																	
		090 ottone	3301 1329																	
		15 ottone	3301 1331																	
Lance hose kit with rotating nozzle • Kit tubo lancia con ugello rotante																				
	Straight • Dritta	040	3301 0777	●	*			●	*					*						
	Straight • Dritta	035	3301 0781										●	*						
	Straight • Dritta	045	3301 0782							●	*						*		*	
	Straight • Dritta	050	3301 0893			●	*													
	Straight • Dritta	055	3301 0895							●	*					*				
	Straight • Dritta	070	3301 0899																	*
	Straight • Dritta	080	3301 1003															*		
	Bent • Angolata	028	3301 1151																	
	Bent • Angolata	037	3301 1024																	
Stainless steel straight rotating nozzle lance with ball quick coupler • Lancia dritta inox ugello rotante con attacco rapido a sfere																				
		045	3301 1305																	
		050	3301 1306																	
		060	3301 1307																	
		070	3301 1308																	
		080	3301 1309																	
		10	3301 1310																	
		13	3301 1311																	
		20	3301 1312																	

ETM				K STEEL TS								K STEEL ECO				K STEEL						K Xtreme							
ETM 71	ETM 100	ETM 130	ETM 150	803	805	807	809	891 15/230T	891 21/180T	991 15/270T	991 21/210T	809 21/150T	801 15/210	901 21/180	1001		1251		1501		15/500	21/350	33/250	18/500	21/450	42/200	21/500		
															21/210	28160	21/250	33/160	42/130	18/350									
				●	●	●	●	●	●	●	●																		
●	●	●	●																										
*	*	*	*																										
				*	*	*	*	*	*	*	*																		
				*	*	*	*	*	*	*	*																		
												●	●	●															
															●	●	●	●	●										
																						●							
																							●						

BLUE SERIES PROFESSIONAL / K STEEL

		K 250										K PREMIUM							
		EXTRA 10/150	CLASSIC 10/150	EXTRA 12/130	CLASSIC 12/130	EXTRA 11/160	CLASSIC 11/160	EXTRA 13/190	CLASSIC 13/190	EXTRA 15/170	CLASSIC 15/170	EXTRA 11/210	CLASSIC 11/210	6.13 T	6.15 T	8.15 T	8.21 T	9.15 T	9.21 T
Accessories • Accessori																			
Lance hose jet kit • Kit tubo lancia getto																			
	ø 1,40	3301 0909												*					
	ø 1,50	3301 0911														*		*	
	ø 1,62	3301 0915													*				*
	ø 1,80	3301 1085																	*
	ø 2,0	3301 1087															*		*
Stainless steel rotating nozzle head • Testina ugello rotante inox 0°																			
	030	3217 0279																	
	050	3217 0281																	
	035	3217 0283																	
	090	3217 0287																	
	15	3217 0286																	
	040	3217 0280																	
Sand/Soda blasting lance kit • Kit lancia sabbiane/bicarbonato																			
	ø 1,2	3301 0771	*	*								*	*						
	ø 1,4	3301 0772			*	*	*	*	*	*	*			*	*	*		*	
	085	3301 0863																	
	ø 1,8	3301 0972															*		*
Sand/Soda blasting lance kit, with ball quick coupler + rubber suction hose + 15° nozzle • Kit lancia sabbiane/bicarbonato, con attacco																			
	055 500 bar	3301 1318																	
	050 500 bar	3301 1320																	
	080 500 bar	3301 1321																	
	09 500 bar	3301 1322																	
	040 500 bar	3301 1333																	
	050 500 bar	3301 1334																	
09 500 bar	3301 1336																		
Professional sand/soda blasting lance kit • Kit lancia sabbiane/bicarbonato professionale																			
	055	3301 0864												*	*	*		*	
	090	3301 0865														*		*	
	040	3301 1219																	
	080	3301 1228																	
Fan shape nozzle 15° or 25°, 1/4" MEG connection (max 350 bar) • Ugello con getto a lama 15° o 25°, attacco 1/4" Meg (max 350 bar)																			
	15 025	3400 0546																	
	15 028	3400 0709																	
	15 033	3400 0712										•	•						
	15 037	3400 0715	•	•			•	•											
	15 043	3400 0717						•	•										
	15 050	3400 0704			•	•													
	25 045	3400 0703														•		•	
	25 040	3400 0702													•				
	25 050	3400 0705																	
	25 053	3400 0746									•	•							
	25 055	3400 0707														•			
	25 060	3400 0708																	
	25 065	3400 0710																	
	25 070	3400 0601																	
	25 075	3400 0713																	•
	25 075	3400 0600																	
	25 080	3400 0714																•	
	25 10	3400 0488																	
	25 13	3400 0489																	
	25 20	3400 0647																	

ETM				K STEEL TS								K STEEL ECO			K STEEL						K Xtreme								
ETM 71	ETM 100	ETM 130	ETM 150	803	805	807	809	891 15/230T	891 21/180T	991 15/270T	991 21/210T	809 21/150T	801 15/210	901 21/180	1001		1251		1501		15/500	21/350	33/250	18/500	21/450	42/200	21/500		
															21/210	28160	21/250	33/160	42/130	18/350									
																							*						
																								*					
																									*				
																										*			
																											*		
																												*	
																													*
																													*
																													*
																													*
																													*
																													*
																													*
																													*
																													*
																													*
																													*
																													*
																													*
																													*
																													*
																													*
																													*
																													*
																													*
																													*
																													*
																													*
																													*
																													*
																													*
																													*
																													*
																													*
																													*
																													*
																													*
																													*
																													*
																													*
																													*
																													*
																													*
																													*
																													*
																													*
																													*
																													*
																													*
																													*
																													*
																													*
																													*
																													*
																													*
																													*
																													*
																													*
																													*
																													*
																													*
																													*
																													*
																													*
																													*
																													*
																													*
																													*
																													*
																													*
																													*
																													*
																													*
																													*
																													*
																													*
																													*
																													*
																													*
																													*
																													*
																													*
																													*
																													*
																													*
																													*
																													*

BLUE SERIES PROFESSIONAL / K STEEL

Accessories • Accessori		K 250												K PREMIUM					
		EXTRA 10/150	CLASSIC 10/150	EXTRA 12/130	CLASSIC 12/130	EXTRA 11/160	CLASSIC 11/160	EXTRA 13/190	CLASSIC 13/190	EXTRA 15/170	CLASSIC 15/170	EXTRA 11/210	CLASSIC 11/210	6.13 T	6.15 T	8.15 T	8.21 T	9.15 T	9.21 T
Washing lance with ball quick coupler, without nozzle • Lancia lavaggio con attacco rapido a sfere, senza ugello																			
		1603 0133																	
		1603 0134																	
Fan shape nozzle 0°, 1/4" MEG connection (max 350 bar) • Ugello con getto a lama 0°, attacco 1/4" Meg (max 350 bar)																			
	0 030	3400 0619																	
	0 035	3400 0621																	
	0 035	3400 0620																	
	0 045	3400 0380																	
	0 050	3400 0622																	
	0 070	3400 0633																	
	0 075	3400 0411																	
	0 090	3400 0645																	
0 15	3400 0626																		
Flat stainless-steel jet nozzle (15° or 25°) with ceramic insert • Ugello inox getto piatto 15° o 25° con inserto in ceramica																			
	15 030	3400 0614																	
	15 035	3400 0615																	
	15 040	3400 0616																	
	15 045	3400 0699																	
	25 050	3400 0618																	
	25 090	3400 0644																	
25 15	3400 0611																		
Nozzle for soda blasting head • Ugello per testa sabbiante																			
	15° - 040	3400 0578																	
	15° - 050	3400 0594																	
	15° - 090	3400 0483																	
Fan-shape nozzle for washing lance and foam lance (M15x1) • Ugello ventaglio per lancia lavaggio e schiumogena (M15x1)																			
	1,5 mm	3400 0662																	
	2,0 mm	3400 0663																	
	2,3 mm	3400 0664																	
	3,0 mm	3400 0665																	
Rotating Brush • Idrospazzola rotante																			
	8÷11 l/min	1413 0029	*	*	*	*	*	*	*	*	*	*	*	*					
	13÷18 l/min	1413 0030													*	*	*	*	*
Professional solar panels washing kit • Kit professionale lavaggio pannelli solari																			
	G3/8 M	1603 0101	*	*	*	*	*	*	*	*	*	*	*	*					
Foam lance kit with regulator • Kit lancia schiumogena con regolatore																			
		3301 0795																	
		3301 0901													*	*	*	*	*
		3301 0766	*	*	*	*	*	*	*	*	*	*	*	*					
Foam lance with ball quick coupler • Lancia schiumogena con attacco rapido a sfere																			
		3301 1303																	
Floor cleaning lance kit • Kit tubo lancia lavapavimenti																			
	SC 155	3301 0710	*	*	*	*	*	*	*	*	*	*	*	*					
Stainless steel floor cleaning lance kit (gun not supplied) • Lancia lavapavimenti inox (pistola non fornita)																			
		3301 1253																	
Professional stainless steel floor cleaning lance • Lancia lavapavimenti professionale inox																			
		3301 1252																	
Drain cleaning kit, 25 m • Kit sonda spurgatubi m 25																			
	16÷21 l/min	3045 0036															*		*
	10÷15 l/min	3045 0041	*	*	*	*	*	*	*	*	*	*	*	*	*	*	*	*	*

ETM				K STEEL TS						K STEEL ECO			K STEEL						K Xtreme									
ETM 71	ETM 100	ETM 130	ETM 150	803	805	807	809	891 15/230T	891 21/180T	991 15/270T	991 21/210T	809 21/150T	801 15/210	901 21/180	1001		1251		1501		15/500	21/350	33/250	18/500	21/450	42/200	21/500	
															21/210	28160	21/250	33/160	42/130	18/350								
															*	*	*	*	*	*								
													*									*						
												*		*									*			*		*
																									*			

BLUE SERIES PROFESSIONAL / K STEEL

K 250

K PREMIUM

Accessories • Accessori

Drain cleaning kit, 25 m with ball quick coupler • Kit sonda spurgatubi m 25 con attacco rapido a sfere

		EXTRA 10/150	CLASSIC 10/150	EXTRA 12/130	CLASSIC 12/130	EXTRA 11/160	CLASSIC 11/160	EXTRA 13/190	CLASSIC 13/190	EXTRA 15/170	CLASSIC 15/170	EXTRA 11/210	CLASSIC 11/210	6.13 T	6.15 T	8.15 T	8.21 T	9.15 T	9.21 T	
	m 16-21 l/min	3045 0047																		
	m 22-33 l/min	3045 0048																		
	m 10-15 l/min	3045 0050																		
	m 16-29 l/min	3045 0051																		
	m 30-42 l/min	3045 0052																		

Rubber delivery hose kit • Kit tubo gomma mandata

		EXTRA 10/150	CLASSIC 10/150	EXTRA 12/130	CLASSIC 12/130	EXTRA 11/160	CLASSIC 11/160	EXTRA 13/190	CLASSIC 13/190	EXTRA 15/170	CLASSIC 15/170	EXTRA 11/210	CLASSIC 11/210	6.13 T	6.15 T	8.15 T	8.21 T	9.15 T	9.21 T	
	m 10 R1-1/4"	3301 0806																		
	m 15 R1-1/4"	3208 0971	•	•	•	•	•	•	•	•	•									
	m 8 R1-1/4"	3208 1012																		
	m 10 R1-1/4"	3208 1050	•	•	•	•	•	•	•	•	•									
	m 10 R2-5/16"	3301 0776																	•	
	m 10 R2-3/8"	3301 0944																		
	m 10 R1-5/16"	3301 0987													•	•	•	•		•
	m 20 R2-3/8" 600 bar	3301 1226																		
	m 20 R2-3/8" 600 bar	3301 1255																		
	m 20 R2-1/2" 310 bar	3301 1268																		
	m 20 R2-1/2" 310 bar	3301 1269																		
	m 20 R2-3/8" 400 bar	3301 1270																		
	m 20 R2-3/8" 400 bar	3301 1271																		
	m 10 R2-1/2"	3301 1286																		
	m 10 R2-3/8"	3301 1314																		
m 10 R2-3/8"	3301 1361																			

Food-industry rubber delivery hose kit • Kit tubo gomma mandata anti-traccia

		EXTRA 10/150	CLASSIC 10/150	EXTRA 12/130	CLASSIC 12/130	EXTRA 11/160	CLASSIC 11/160	EXTRA 13/190	CLASSIC 13/190	EXTRA 15/170	CLASSIC 15/170	EXTRA 11/210	CLASSIC 11/210	6.13 T	6.15 T	8.15 T	8.21 T	9.15 T	9.21 T	
	m 10 R1-5/16"	3301 0559																		
	m 10 R2-5/16"	3301 0599																		
	m 10 R2-3/8"	3301 1247																		

Rubber delivery hose extension kit • Kit prolunga tubo gomma mandata

		EXTRA 10/150	CLASSIC 10/150	EXTRA 12/130	CLASSIC 12/130	EXTRA 11/160	CLASSIC 11/160	EXTRA 13/190	CLASSIC 13/190	EXTRA 15/170	CLASSIC 15/170	EXTRA 11/210	CLASSIC 11/210	6.13 T	6.15 T	8.15 T	8.21 T	9.15 T	9.21 T	
	m 8 R1-1/4"	3301 0769	*	*	*	*	*	*	*	*	*	*	*							
	m 10 R1-5/16"	3301 0774												*	*	*	*		*	
	m 10 R2-3/8"	3301 0946																		
	m 10 R2-5/16"	3301 0985																	*	
	m 20 R2-3/8"	3301 1271																		
m 30 R2-1/2"	3301 1278																			

Food-industry rubber delivery hose extension kit • Kit prolunga tubo gomma mandata antitraccia

		EXTRA 10/150	CLASSIC 10/150	EXTRA 12/130	CLASSIC 12/130	EXTRA 11/160	CLASSIC 11/160	EXTRA 13/190	CLASSIC 13/190	EXTRA 15/170	CLASSIC 15/170	EXTRA 11/210	CLASSIC 11/210	6.13 T	6.15 T	8.15 T	8.21 T	9.15 T	9.21 T	
	m 10 R2-5/16"	3301 1249																		
	m 10 R1-5/16"	3301 1248																		
	m 10 R2-3/8"	3301 1250																		





Hose reel with rubber hose • Avvolgitubo girevole con tubo gomma

		EXTRA 10/150	CLASSIC 10/150	EXTRA 12/130	CLASSIC 12/130	EXTRA 11/160	CLASSIC 11/160	EXTRA 13/190	CLASSIC 13/190	EXTRA 15/170	CLASSIC 15/170	EXTRA 11/210	CLASSIC 11/210	6.13 T	6.15 T	8.15 T	8.21 T	9.15 T	9.21 T	
	m 15 R1-5/16"	7002 0279												•	•	•	•		•	
	m 15 R1-5/16"	7002 0281												*	*	*	*		*	
	m 15 R2-5/16"	7002 0285																	•	
	m 15 R2-3/8"	7002 0287																	*	
	m 15 R1-5/16"	7002 0315																		
	m 15 R2-5/16"	7002 0316																		
	m 15 R2-3/8"	7002 0317																		
	stainless steel with blue food-industry hose, 20 m inox con tubo blu antitr.	m 20 R2-5/16"	7002 0304																	
	stainless steel without rubber hose inox senza tubo gomma	max 30 m R2-5/16"	7002 0329																	
		max 40 m R1-5/16"																		
	m 15 R1-1/4"	7002 0399	*	*	*	*	*	*	*	*	*									
	m 20 R1-1/16"	7002 0400	*	*	*	*	*	*	*	*	*									

ETM				K STEEL TS					K STEEL ECO			K STEEL			K Xtreme															
ETM 71	ETM 100	ETM 130	ETM 150	803	805	807	809	891 15/230T	891 21/180T	991 15/270T	991 21/210T	809 21/150T	801 15/210	901 21/180	1001		1251		1501		15/500	21/350	33/250	18/500	21/450	42/200	21/500			
															21/210	28/160	21/250	33/160	42/130	18/350										
												*	*	*	*		*		*											
																*		*	*			*	*			*	*	*		
																								*						*

ETM				K STEEL TS						K STEEL ECO			K STEEL						K Xtreme										
ETM 71	ETM 100	ETM 130	ETM 150	803	805	807	809	891 15/230T	891 21/180T	991 15/270T	991 21/210T	809 21/150T	801 15/210	901 21/180	1001		1251		1501		15/500	21/350	33/250	18/500	21/450	42/200	21/500		
															21/210	28160	21/250	33/160	42/130	18/350									
												*	*	*															
																*	*	*		*									
																						*					*		
																*	*	*		*			*	*		*	*	*	*
*	*	*	*																										
*	*	*	*																										
				*	*	*	*																						
																*		*	*										
								●	●	●	●	*	*	*	*		*			*		*							
*	*	*	*	*	*	*	*	*	*	*	*	*	*	*															
*	*	*	*	*	*	*	*	*	*	*	*	*	*	*															
				●	●	●	●	●	●	●	●	●	●	●															
															●	●	●	●	●	●	●	●	●	●	●	●	●	●	
															●	●	●	●	●	●	●	●	●	●	●	●	●	●	
																				*		*	*	*	*	*	*	*	
				*	*	*	*	*	*	*	*	*	*	*	*	*	*	*	*			*	*	*	*	*	*	*	

BLUE SERIES PROFESSIONAL / K STEEL

Accessories • Accessori			K 250												K PREMIUM				
			EXTRA 10/150	CLASSIC 10/150	EXTRA 12/130	CLASSIC 12/130	EXTRA 11/160	CLASSIC 11/160	EXTRA 13/190	CLASSIC 13/190	EXTRA 15/170	CLASSIC 15/170	EXTRA 11/210	CLASSIC 11/210	6.13 T	6.15 T	8.15 T	8.21 T	9.15 T
Quickfit kit • Kit attacco rapido																			
	M22	0011 0026																	
Stainless steel lance hose kit with foam nozzle + quick kit M22 • Kit tubo lancia inox con ugello schiuma + kit attacco rapido M22																			
	mm 500 M22	3301 1275																	
Stainless steel foam system device • Dispositivo sistema schiuma inox																			
		0608 0076																	
Protective clothing kit • Kit abbigliamento protettivo																			
		0608 0070																	
Sludge pump • Lancia aspirafango																			
	030	3410 0373	*	*			*	*					*	*	*				
	050	3410 0375			*	*			*	*	*	*				*	*	*	
	085	3410 0377															*		*
	050	3410 0378																	
	095	3410 0379																	
	075	3410 0380																	
	15	3410 0374																	

ETM				K STEEL TS						K STEEL ECO			K STEEL						K Xtreme										
ETM 71	ETM 100	ETM 130	ETM 150	803	805	807	809	891 15/230T	891 21/180T	991 15/270T	991 21/210T	809 21/150T	801 15/210	901 21/180	1001		1251		1501		15/500	21/350	33/250	18/500	21/450	42/200	21/500		
															21/210	28160	21/250	33/160	42/130	18/350									
												*	*	*															
												*	*	*															
												*	*	*															
																							*	*	*	*	*	*	*
*	*																												
		*	*	*	*	*		*	*																				
							*			*	*																		
																							*	*		*	*		*
												*	*	*	*	*	*							*			*		
																	*	*	*										

FDX 4						FDX XTREME						FDX WB		PTO				FDX HOT CUBE									
16/200 FW2 Yammar	21/160 FW2 Yammar	16/200 FW2 Honda	16/250 RW Honda	18/220 RW Honda	21/200 RW Honda	Petrol Engine / Motore Benzina			Diesel Engine / Motore Diesel			8/160 LWD-K	8/160 BWD-K	15/150	21/200	23/200	30/170	16/200 D	16/200 B	21/160 D	21/160 B						
						15/500	18/400	21/350	30/280	36/230	42/200	15/500	18/400	21/350	30/280	36/230	42/200										
●		●	●	●	●															●	●	●	●	●	●	●	●
*		*	*	*	*																			*	*	*	*
*		*	*	*	*																			*	*	*	*
																		*	*								
						●	●	●	●	●	●	●	●	●	●	●	●										
*		*	*	*	*													●	●					*	*	*	*
●		●	●	●	●	●	●	●	●	●	●	●	●	●	●	●	●	*	*	●	●	●	●	●	●	●	●
																		*	*								
*		*	*		*																			*	*		
	*			*																						*	*
					*																						
*		*	*		*													*	*					*	*		
				*																							
	*			*																		*	*			*	*

FDX 2

FDX Pro

Accessories • Accessori

Axial Pumps / Pompe Assiali					Triplex					FDX Pro					
10/150	12/200	13/150	12/200	14/200	12/140	13/180	16/210	16/250	15/270	15/270	15/300	16/200	16/250	18/220	15/150

Stainless-steel lance with rotating nozzle with quick coupler M24x1,5 (600 bar) • Lancia inox con ugello rotante con attacchi rapidi M24x1,5 (600 bar)

030 inox	3301 1324														
040 inox	3301 1325														
050 inox	3301 1327														
075 ottone	3301 1328														
12 ottone	3301 1330														
15 ottone	3301 1331														

Fan shape nozzle 15° or 25°, 1/4" MEG connection • Ugello con getto a lama 15° or 25° attacco 1/4" MEG

15 033	3400 0712	●													
15 037	3400 0715		●	●											
15 043	3400 0717					●		●							
25 030	3400 0606														
25 035	3400 0701										●				
25 040	3400 0702									●					
25 045	3400 0703					●			●				●		
25 050	3400 0705		●			●		●			●				
25 055	3400 0707													●	
25 060	3400 0708														●
25 065	3400 0710														
25 070	3400 0711														
25 075	3400 0713														
25 080	3400 0714														
25 10	3400 0523														

Concentrated stainless-steel jet nozzle 0° with ceramic insert • Ugello inox getto concentrato 0° con inserto in ceramica

0 030	3400 0619														
0 040	3400 0620														
0 050	3400 0622														
0 080	3400 0625														
0 11	3400 0624														
0 15	3400 0626														

Flat stainless-steel jet nozzle (15° or 25°) with ceramic insert • Ugello inox getto piatto 15° o 25° con inserto in ceramica

15 030	3400 0614														
15 040	3400 0616														
25 050	3400 0618														
25 080	3400 0612														
25 11	3400 0613														
25 15	3400 0611														

Nozzle soda blasting head and tungsten carbide • Ugello per testa sabbiante in carburo di tungsteno

15° - 040	3400 0578														
15° - 050	3400 0594														
15° - 080	3400 0595														
15° - 090	3400 0483														













FDX 4						FDX XTREME						FDX WB		PTO			FDX HOT CUBE														
16/200 FW2 Yammar	21/160 FW2 Yammar	16/200 FW2 Honda	16/250 RW Honda	18/220 RW Honda	21/200 RW Honda	Petrol Engine / Motore Benzina			Diesel Engine / Motore Diesel			8/160 LWD-K	8/160 BWD-K	15/150	21/200	23/200	30/170	16/200 D	16/200 B	21/160 D	21/160 B										
						15/500	18/400	21/350	30/280	36/230	42/200	15/500	18/400	21/350	30/280	36/230	42/200														
						*						*																			
							*						*																		
								*						*																	
									*						*																
										*						*															
											*						*														
									</																						













X-SPECIAL COLD WATER / HOT WATER

			FDX 2					FDX Pro											
			Axial Pumps / Pompe Assiali					Triplex											
			10/150	12/200	13/150	12/200	14/200	12/140	13/180	16/210	16/250	15/270	15/270	15/300	16/200	16/250	18/220	15/150	
Accessories • Accessori																			
Stainless steel rotating nozzle head • Testina ugello rotante 0°																			
	030 inox	3217 0279																	
	040 inox	3217 0280																	
	050 inox	3217 0281																	
	075 ottone	3217 0284																	
	12 ottone	3217 0278																	
	15 ottone	3217 0286																	
Sand/Soda blasting lance kit • Kit lancia sabbicante/bicarbonato																			
		3301 0801	*	*															
	ø 1,4	3301 0772			*	*	*	*	*	*	*	*	*	*	*	*	*	*	*
	055	3301 0864													*		*	*	
	ø 1,8	3301 0972														*	*	*	
	040 500 bar	3301 1219										*	*			*			
	080 500 bar	3301 1228																	
	Sand/Soda blasting lance kit, with ball quick coupler + rubber suction hose + 15° nozzle • Kit lancia sabbicante/bicarbonato, con attacco																		
	15° - 040	3301 1333																	
	15° - 050	3301 1334																	
	15° - 080	3301 1335																	
	15° - 090	3301 1336																	
Rotating brush • Idrospazzola rotante																			
	8- 11 l/min	1413 0029				*		*											
	13- 18 l/min	1413 0030			*		*		*	*	*	*	*	*	*	*	*	*	*
		1413 0032	*	*															
		1413 0033	*	*															
Professional solar panels washing kit • Kit professionale lavaggio pannelli solari																			
	G3/8 M	1603 0101	*	*	*	*	*	*	*	*	*	*							
Kit foam lance kit • Kit lancia schiumogena																			
		3301 0795	●																
		3301 0901		*	*	*	*	*	*	*	*	*	*	*	*	*	*	*	*
Drain cleaning kit • Kit sonda spurgatubi																			
	6- 9 l/min	3045 0034																	
	16- 21 l/min	3045 0036								*	*		*	*	*	*	*	*	
	10- 15 l/min	3045 0041	*	*	*	*	*	*	*	*		*							
	22- 33 l/min	3045 0044																	
	10- 15 l/min	3045 0050																	
	16- 29 l/min	3045 0051																	
	30- 42 l/min	3045 0052																	
Rubber delivery hose kit • Kit tubo gomma mandata																			
	m 8 R1-1/4"	3208 1012		●	●	●													
	m 8 R1-1/4"	3208 1015	●																
	m 10 R2-3/8"	3301 0944																	
	m 10 R2-5/16"	3301 0776									●	●	●	●	●	●	●	●	●
	m 10 R1-5/16"	3301 0987					●	●	●	●									
	m 10 R2-3/8"	3301 0658																	
Rubber delivery hose kit with quick coupling M24x1,5 • Kit tubo gomma mandata con innesti rapidi M24x1,5																			
	m 20 R2-3/8" 600 bar	3301 1226																	
	m 20 R2-3/8" 400 bar	3301 1270																	
	m 20 R2-1/2" 310 bar	3301 1268																	

FDX 4						FDX XTREME						FDX WB		PTO			FDX HOT CUBE												
16/200 FW2 Yammar	21/160 FW2 Yammar	16/200 FW2 Honda	16/250 RW Honda	18/220 RW Honda	21/200 RW Honda	Petrol Engine / Motore Benzina			Diesel Engine / Motore Diesel			8/160 LWD-K	8/160 BWD-K	15/150	21/200	23/200	30/170	16/200 D	16/200 B	21/160 D	21/160 B								
						15/500	18/400	21/350	30/280	36/230	42/200	15/500	18/400	21/350	30/280	36/230	42/200												
						*						*																	
							*						*																
								*						*															
									*						*														
										*						*													
											*						*												
*		*	*										*	*								*	*						
*		*	*	*									*	*								*	*						
	*			*	*																			*	*			*	*
*		*	*	*	*								*	*								*	*					*	*
*		*	*	*	*								*	*					*	*	*							*	*
						*						*																*	*
							*	*					*	*															
									*	*	*				*	*	*												

X-SPECIAL COLD WATER / HOT WATER

			FDX 2					FDX Pro											
			Axial Pumps / Pompe Assiali					Triplex											
			10/150	12/200	13/150	12/200	14/200	12/140	13/180	16/210	16/250	15/270	15/270	15/300	16/200	16/250	18/220	15/150	
Accessories • Accessori																			
Thermostatic valve • Valvola termostatica																			
	G 3/8M	1215 0354		*	*	*	*												
	G 1/2M	1215 0355						*	*	*	*	*	*	*	*	*	*	*	*
	G 1/2M	1215 0388																	
Spiral suction hose kit • Kit tubo aspirazione spirato																			
	m 8	3299 0019			*	*	*	*	*	*	*	*	*	*	*	*	*	*	*
Injector kit • Kit eiettore																			
	ø 2,1	3410 0372																	
	ø 2,7	3410 0333																	
Water suction filter • Filtro aspirazione acqua																			
		1002 0159											●	●	●	●	●	●	●
	50 mesh 70 l/min	1002 0238																	
	cartuccia cartridge 50 mesh	1002 0239																	
Engine rev decelerator kit • Kit deceleratore giri motore																			
		0608 0069											●	●	●	●	●	●	●
Flame control kit • Kit comando controllo fiamma																			
		5018 0081																	
Suction strainer kit • Kit cestina di fondo																			
	ø 25 mm	0401 0038																	
PTO frame kit • Kit telaio PTO																			
		3206 0295																	
Foot pedal valve • Valvola pedale																			
	G 3/8"	0608 0071																	
	G 3/8"	0608 0097	*	*	*	*	*	*	*	*	*	*	*	*	*	*	*	*	*
Protective clothing kit • Kit abbigliamento protettivo																			
		0608 0070																	
Sludge pump kit • Kit lancia aspirafango																			
	030	3410 0373	*			*													
	050	3410 0375			*		*	*	*	*	*	*	*	*	*	*	*	*	*
	060	3410 0376															*	*	*
	085	3410 0377																	
	050	3410 0378																	
	095	3410 0379																	

			TRAPPER 2	SCOUT				
Accessories • Accessori				GOLD 130 G	CLASSIC 150 C	EXTRA 150 E	CLASSIC 135 C	EXTRA 135 E
Gun kit with guard • Kit pistola con protezione								
	GH 251		2410 0096	●	●	●	●	●
	GH 281 + pressure unloader valve GH 281 + reg.pressione	G 1/4 M	2410 0225	*	*	*	*	*
Bent lance + detergent head without nozzle • Lancia angolata con testina detergente senza ugello								
		mm 700	3301 0787		●	●	●	●
		mm 500	3301 1143	●				
Lance with adjustable jet kit • Kit tubo lancia getto regolabile								
		ø 1,2	3301 0927				*	*
		ø 1,1	3301 1054		*	*		
Lance with rotating nozzle kit • Kit tubo lancia con ugello rotante								
		04	3301 0777				*	*
		035	3301 0780	*	*	*		
Double barrel lance kit • Kit tubo lancia canna doppia								
		mm 700	3301 0941	*	*	*	*	*
	+ det. nozzle + ugello det.	ø 4	3400 0391	*	*	*	*	*
Fan shape nozzle 15° attacco 1/4" MEG • Ugello con getto a lama 15° attacco 1/4" MEG								
		ø 1,04 15 028	3400 0709		●	●		
		ø 1,17 15 037	3400 0715				●	●
		25° ø 1,0 15 025	3400 0546	●				
Sand/Soda blasting lance kit • Kit lancia sabbiane/bicarbonato								
		ø 1,2	3301 0989	*	*	*	*	*
Foam lance kit • Kit lancia schiumogena								
			3301 0766		*	*	*	*
			3301 0795	●				
Rotating brush max 60° • Idrospazzola rotante max 60°								
		13± 18 l/min	1413 0033	*	*	*	*	*

			TRAPPER 2		SCOUT		
Accessories • Accessori			GOLD 130 G	CLASSIC 150 C	EXTRA 150 E	CLASSIC 135 C	EXTRA 135 E
Drain cleaning kit • Kit sonda spurgatubi							
	m 8 6 ÷ 9 l/min	3045 0028	*	*	*		
	m 15 6 ÷ 9 l/min	3045 0029	*	*	*		
	m 25 10 ÷ 15 l/min	3045 0041				*	*
Rubber delivery hose kit • Kit tubo gomma mandata							
	m 8 R1-1/4"	3208 1015	●	●		●	
	m 10 R1-1/4"	3208 1016			●		●
Rubber delivery hose extension kit • Kit prolunga tubo gomma mandata							
	m 10 R1-5/16"	3301 0774		*		*	
	m 8 R1-1/4"	3301 0811	*		*		*
Kit tubo aspirazione spiralato • Spiral suction hose kit							
	m 8	3299 0019	*	*	*	*	*
Back-flow preventer kit BA 10 • Kit disconnettore idrico BA 10							
	G3/4M G3/4M	0608 0049	*	*	*	*	*
	G3/4F G3/4F	5002 0024	*	*	*	*	*
Anti-scale device • Dispositivo anticalcare							
		0608 0047	*	*	*	*	*
Water suction filter • Filtro aspirazione acqua							
		1002 0129		*	*	*	*
Flame control kit • Kit comando controllo fiamma							
		5018 0114	*	*	*	*	*
Sludge pump kit • Kit lancia aspirafango							
	030	3410 0373	*	*	*	*	*

RED SERIES PROFESSIONAL

Accessories • Accessori			KP				KP PRO				KM CLASSIC				with Water tank and Anti-scale tank con Vasch. acqua e Anticalcare				
			3.10 Classic	5.12 Classic	3.10 Extra	5.12 Extra	3.10 Classic	5.12 Classic	3.10 Extra	5.12 Extra	3.11	5.13	5.15	8.15	3.11	5.13	5.15	8.15	
Gun kit with guard <i>Kit pistola con protezione</i>																			
	GH 251 with protection <i>GH 251 con protezione</i>		2410 0096	•	•	•	•												
	GH 281 + pressure unloader valve <i>GH 281 + regolatore pressione</i>	G 3/8 M	2410 0222	*	*	*	*	•	•	•	•	*	*	*	*	*	*	*	*
	GH 351 + Swivel (n. 2 o-ring)		2410 0114																
	GH 351 + revolving lance + det. head <i>GH 351 + lancia girevole + testa det.</i>		2410 0124	*	*	*	*	*	*	*	*	*	*	*	*	*	*	*	*
	GH 351 + fixed lance + det. head <i>GH 351 + lancia fissa + testa det.</i>		2410 0126	*	*	*	*	*	*	*	*	*	*	*	*	*	*	*	*
	GH 351 + fixed lance + nozzle holder head <i>GH 351 + lancia fissa + testa portaugello</i>		2410 0128																
	GH 351 + swivel lance+nozzle holder head <i>GH 351 + lancia girevole + testa portaugello</i>		2410 0130																
	GH 301 with Swivel <i>GH 301 con Swivel</i>		2410 0182									•	•	•	•	•	•	•	•
Bent lance + detergent head without nozzle • <i>Lancia angolata con testina detergente senza ugello</i>																			
		mm 700	3301 0787	•	•	•	•	•	•	•	•	•	•	•	•				
		mm 700	3301 0976																
Bent lance, with nozzle holder (without nozzle) • <i>Lancia angolata, testa portaugello(senza ugello)</i>																			
		mm 700	3301 1354													•	•	•	•
		mm 700	3301 0974																
Lance with adjustable jet kit • <i>Kit tubo lancia getto regolabile</i>																			
		ø 1,3	3301 0507	•		•													
		ø 1,4	3301 0909		•		•	•	•	•	•								
		ø 1,5	3301 0911										*				*		
		ø 1,55	3301 0913									*			*	*			*
		ø 1,62	3301 0915										*					*	
		ø 1,8	3301 1085																
		ø 1,65	3301 1094																
Lance hose kit with rotating nozzle • <i>Kit tubo lancia con ugello rotante</i>																			
		035	3301 0781	•		•													
		040	3301 0777		•		•	•	•	•	•								
		045	3301 0782										*				*		
		050	3301 0893									*			*	*			*
		055	3301 0895										*					*	
		060	3301 0897																
		070	3301 0899																
Double barrel lance kit • <i>Kit tubo lancia canna doppia</i>																			
		mm 700	3301 0941	*	*	*	*	*	*	*	*	*	*	*	*	*	*	*	*
	+det. nozzle + ugello det.	ø 4	3400 0391	*	*	*	*	*	*	*	*	*	*	*	*	*	*	*	*
Fan shape nozzle 15°, 1/4" MEG connection • <i>Ugello con getto a lama 15°, attacco 1/4" MEG</i>																			
		15 035	3400 0677	•		•													
		15 037	3400 0715					•		•									
		15 040	3400 0690		•		•		•		•								
		25 045	3400 0703										•				•		
		25 050	3400 0705									•			•	•			•
		25 055	3400 0707											•				•	
		25 060	3400 0708																
		25 070	3400 0711																
		25 065	3400 0710																









KM EXTRA				KE PREMIUM PLUS 15/200			KF CLASSIC <i>without water tank senza vaschetta acqua</i>		KF CLASSIC <i>with water tank con vaschetta acqua</i>						KF EXTRA						
3.11	5.13	5.15	8.15	STD	Water tank <i>vasch. acqua</i>	Anti-scale tank <i>Anticalcare</i>	6.15	8.15	6.15	8.15	9.18	9.21	10.18	10.21	6.15	8.15	9.18	9.21	10.18	10.21	
●	●	●	●	●	●	●	●	●	●	●	●	●	●	●	●	●	●	●	●	●	●
●	●	●	●	●	●	●	●	●	●	●	●	●	●	●	●	●	●	●	●	●	●
				*			*	*													
				*			*	*													
*	*	*	*		*	*			*	*	*	*	*	*	*	*	*	*	*	*	*
*	*	*	*		*	*			*	*	*	*	*	*	*	*	*	*	*	*	*
				●			●	●													
●	●	●	●		●	●			●	●	●	●	●	●	●	●	●	●	●	●	●
*	*		*		*	*	*			*						*					
		*						*	*		*		*		*		*		*		*
							*			*	*	*	*	*	*	*	*	*	*	*	*
	*			*	*	*	*		*	*			*		*		*		*		*
*	*	*	*	*	*	*	*	*	*	*	*	*	*	*	*	*	*	*	*	*	*
*	*	*	*	*	*	*	*	*	*	*	*	*	*	*	*	*	*	*	*	*	*
●	●		●	●	●	●			●						●						
		●					●	●	●	●		●		●	●		●		●		●
											●						●		●		●
												●		●				●		●	●

RED SERIES PROFESSIONAL

			KP				KP PRO				KM CLASSIC				with Water tank and Anti-scale tank con Vasch. acqua e Anticalcare			
			3.10 Classic	5.12 Classic	3.10 Extra	5.12 Extra	3.10 Classic	5.12 Classic	3.10 Extra	5.12 Extra	3.11	5.13	5.15	8.15	3.11	5.13	5.15	8.15
Accessories • Accessori																		
Sand/Soda blasting lance kit • Kit lanca sabbiate/bicarbonato																		
	ø 1,4	3301 0772	*	*	*	*	*	*	*	*	*	*	*	*	*	*	*	*
	ø 1,8	3301 0972										*				*		
Foam lance kit with regulator • Kit lancia schiumogena con regolatore																		
		3301 0901	*	*	*	*	*	*	*	*	*	*	*	*	*	*	*	*
Rotating brush max 60° • Idrospazzola rotante max 60°																		
	8÷ 11 l/min	1413 0029	*		*		*		*		*			*				
	13÷ 18 l/min	1413 0030		*		*		*		*		*	*	*		*	*	*
Professional solar panels washing kit (max 60°C) • Kit professionale lavaggio pannelli solari (max 60°C)																		
	G3/8 M	1603 0101									*	*	*	*	*	*	*	*
Drain cleaning kit, 25 m • Kit sonda spurgatubi m 25																		
	15÷ 21 l/min	3045 0036																
	10÷ 15 l/min	3045 0041	*	*	*	*	*	*	*	*	*	*	*	*	*	*	*	*
Rubber delivery hose kit • Kit tubo gomma mandata																		
	m 10 R1-1/4"	3208 1050	●				●				●			●				
	m 10 R2-5/16"	3301 0776											●					●
	m 10 R2-3/8"	3301 0944																
	m 10 R1-5/16"	3301 0987		●			●				●	●			●	●		
Rubber delivery hose extension kit • Kit prolunga tubo gomma mandata																		
	m 8 R1-1/4"	3301 0796									*			*				
	m 10 R1-5/16"	3301 0774	*	*			*	*			*	*			*	*		
	m 10 R2-3/8"	3301 0946																
	m 10 R2-5/16"	3301 0985											*					*
	m 15 R2-5/16"	3301 0991																
Spiral suction hose kit • Kit tubo aspirazione spirato																		
	m 8	3299 0019	*	*	*	*	*	*	*	*	*	*	*	*	*	*	*	*
Hose reel • Avvolgitubo																		
	m 15 R1-1/4"	7002 0241			●				●									
	m 15 R1-5/16"	7002 0279				●				●								
Hose reel with rubber hose • Avvolgitubo girevole con tubo gomma																		
	m 20 R2-5/16"	7002 0382																
	m 20 R2-3/8"	7002 0383																
	m 20 R1-5/16"	7002 0381																
	m 15 R1-5/16"	7002 0385								*	*	*		*	*	*		
	m 15 R2-5/16"	7002 0386								*	*	*	*	*	*	*	*	*
Steam nozzle kit with curved lance • Kit ugello vapore con lancia curva																		
	mm 700	3301 1100																





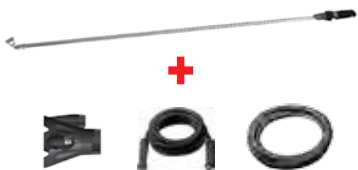

KM EXTRA				KE PREMIUM PLUS 15/200			KF CLASSIC <i>without water tank senza vaschetta acqua</i>		KF CLASSIC <i>with water tank con vaschetta acqua</i>						KF EXTRA						
3.11	5.13	5.15	8.15	STD	Water tank <i>vasch. acqua</i>	Anti-scale tank <i>Anticalcare</i>	6.15	8.15	6.15	8.15	9.18	9.21	10.18	10.21	6.15	8.15	9.18	9.21	10.18	10.21	
*	*		*	*	*	*		*	*	*	*		*		*	*			*		
		*					*				*	*		*			*	*		*	
*	*	*	*	*	*	*	*	*	*	*	*	*	*	*	*	*	*	*	*	*	*
*																					
	*	*	*	*	*	*	*	*	*	*	*		*		*	*	*		*		
*	*	*	*																		
				*	*	*					*	*	*	*			*	*	*	*	
*	*	*	*				*	*	*	*					*	*					
●																					
			●	●	●	●		●		●						●					
	●	●					●		●		●	●	●	●	●		●	●	●	●	
*																					
	*	*					*		*						*						
											*	*	*	*			*	*	*	*	
			*	*	*	*		*		*						*					
				*	*	*															
*	*	*	*	*	*	*	*	*	*	*	*	*	*	*	*	*	*	*	*	*	*
				*	*	*		*		*						*					
											*	*	*	*			*	*	*	*	
*	*	*					*		*						*						
*	*	*	*																		
*	*	*	*												*	*	*	*	*	*	









RED SERIES PROFESSIONAL

			KP				KP PRO				KM CLASSIC				with Water tank and Anti-scale tank con Vasch. acqua e Anticalcare			
			3.10 Classic	5.12 Classic	3.10 Extra	5.12 Extra	3.10 Classic	5.12 Classic	3.10 Extra	5.12 Extra	3.11	5.13	5.15	8.15	3.11	5.13	5.15	8.15
Accessories • Accessori																		
Exhausted fumes conveyor • Convogliatore di fumi esausti camino																		
		0466 0055	*	*	*	*	*	*	*	*	*	*	*	*	*	*	*	*
Back-flow preventer kit BA 10 • Kit disconnettore idrico BA 10																		
	G3/4M G3/4M	0608 0049	*	*	*	*	*	*	*	*	*	*	*	*	*	*	*	*
	Garden hose quick couplers Kit raccordi attacco rapido 3/4	G3/4F G3/4F	5002 0024	*	*	*	*	*	*	*	*	*	*	*	*	*	*	*
Anti-scale device • Dispositivo anticalcare																		
		0608 0047	*	*	*	*	*	*	*	*	*	*	*	*	*	*	*	*
Detergent solenoid valve kit • Kit elettrovalvola detergente																		
	230 V	0802 0024													*	*	*	*
	24 V	0802 0015																
	24 V	0802 0025																
Flame control kit • Kit comando controllo fiamma																		
		5018 0081																
		5018 0114	*	*	*	*	*	*	*	*	*	*	*	*	*	*	*	*
		5018 0115																
Anti-scale tank kit • Kit serbatoio anticalcare																		
		5018 0092																
Foot pedal valve • Valvola pedale																		
	G 3/8"	0608 0097									*	*	*	*	*	*	*	*
Sludge pump kit • Kit lancia aspirafango																		
	030	3410 0373									*	*	*	*	*	*	*	*
	050	3410 0375									*	*		*	*	*		*
	060	3410 0376											*				*	
	085	3410 0377																

KM EXTRA				KE PREMIUM PLUS 15/200			KF CLASSIC without water tank senza vaschetta acqua		KF CLASSIC with water tank con vaschetta acqua						KF EXTRA							
3.11	5.13	5.15	8.15	STD	Water tank <i>vasch. acqua</i>	Anti-scale tank <i>Anticalcare</i>	6.15	8.15	6.15	8.15	9.18	9.21	10.18	10.21	6.15	8.15	9.18	9.21	10.18	10.21		
*	*	*	*	*	*	*	*	*	*	*	*	*	*	*	*	*	*	*	*	*	*	
				*	*	*	*	*														
				*	*	*	*	*														
				*			*	*														
				*	*	*			*	*	*	*	*	*	*	*	*	*	*	*	*	
*	*	*	*																			
●	●	●	●												*	*	*	*	*	*	*	
				*	*	*	*	*	*	*	*	*	*	*								
					*	●			*	*	*	*	*	*	●	●	●	●	●	●	●	
*	*	*	*	*	*	*	*	*	*	*	*	*	*	*	*	*	*	*	*	*	*	*
*	*	*	*	*	*	*									*							
							*	*	*	*						*	*		*			
																		*		*		

ACCESSORIES - ACCESSORI

Modello Model	Codice Code	Tubo flessibile Flexible hose		Prolunga / Extension tube			Bocchetta / Attachment
		bocchetta attachment	tubo standard standard hose	dritta plastica straight plastic	curve acciaio cromato bent chrome-plated steel	dritte acciaio cromato straight chrome-plated steel	lancia lance
							
AC 18 ASPIRACENERE	9350 0038	3208 1131					0219 0024
AS 20-P	9350 0045		3208 1275	2417 0096			0219 0027
AS 21-X	9350 0050		3208 1275	2417 0096			0219 0027
AS 31-X	9350 0051		3208 1275	2417 0096			0219 0027
AS 35 PRO-P	9350 0052		3208 1045		3208 1047	3208 1046	0219 0006
AS 50 PRO-X	9350 0053		3208 1045		3208 1047	3208 1046	0219 0006

Modello Model	Codice Code	Tubo flessibile / Flexible hose				Bocchetta / Attachment				
		tubo standard standard hose	elettrot. power-driven	idrolitico hydrolytic	antistatico antistatic	curve acciaio cromato bent chrome- plated steel	dritte acciaio cromato straight chrome- plated steel	lancia lance	lava moquette carpet cleaning	lava poltrone couch cleaning
										
AS 70 PRO-X	9350 0054	3208 1045								
AS 70 PRO-B2-X	9350 0055					3208 1047	3208 1046	0219 0006		
AS 37 VIBRA	9350 0032	3208 1045	3208 1048							
AS 75 F2	9350 0025	3208 1045								
AS 77 B2	9350 0026	3208 1045								
AS 78 B3	9350 0027	3208 1045								
ASL 76-2	9350 0029	3208 1045		3208 1049						
ASL 81-B3 METALOIL	9350 0033	3208 1112			3208 1111	3208 1113		0219 0012 0219 0014 0219 0015 0219 0016		

Bocchetta / Attachment		Spazzola pennello <i>Brush attachment</i>	Telaio per spazzola combin. <i>Support for combi-brush</i>	Racla		Spazzola / Brush			
per imbottiti <i>for soft furnishings</i>				polveri / liquidi <i>dust / liquids</i>		moquette <i>carpet</i>	liquidi <i>liquids</i>	polveri <i>dust</i>	pulisci griglia <i>grill cleaner</i>
									3046 0036
0219 0028		3046 0037	3206 0370	3046 0038					
0219 0028		3046 0037	3206 0370	3046 0038					
0219 0028		3046 0037	3206 0370	3046 0038					
		3046 0027				3046 0030	3046 0029	3046 0028	
		3046 0027				3046 0030	3046 0029	3046 0028	

Bocchetta / Attachment		Spazzola pennello <i>Brush attachment</i>	Telaio per spazzola combin. <i>Support for combi-brush</i>	Racla			Spazzola / Brush			Cestello / Basket	
per detriti <i>for dirt-intake</i>	ventosa ondulata <i>corrugated squeegee</i>			moquette <i>carpet</i>	liquidi <i>liquids</i>	polveri <i>dust</i>	moquette <i>carpet</i>	liquidi <i>liquids</i>	polveri <i>dust</i>	porta accessori <i>accessories storage</i>	inferiore porta accessori <i>lower accessories storage</i>
		3046 0027					3046 0030	3046 0029	3046 0028	3002 0625	
		3046 0027	3206 0318	3046 0032		3046 0031	3046 0030	3046 0029	3046 0028		
		3046 0027					3046 0030	3046 0029	3046 0028		
		3046 0027					3046 0030	3046 0029	3046 0028	3002 0625	3002 0628
		3046 0027					3046 0030	3046 0029	3046 0028	3002 0625	3002 0628
		3046 0027					3046 0030	3046 0029	3046 0028		3002 0628
0219 0017	0219 0013	3046 0035	3206 0319		3046 0034	3046 0033				3002 0625	

NOZZLES
 UGELLI

STAINLESS STEEL 350 BAR PACKED NOZZLE
 UGELLO INOX 350 BAR CONFEZIONATO

DIAMETER DIAMETRO	JET ANGLE ANGOLO GETTO	CODE CODICE
030	0°	3400 0404
035	0°	3400 0398
040	0°	3400 0396
045	0°	3400 0380
050	0°	3400 0384
055	0°	3400 0381
060	0°	3400 0630
065	0°	3400 0383
070	0°	3400 0633
075	0°	3400 0411
085	0°	3400 0395
090	0°	3400 0635

025	15°	3400 0546
028	15°	3400 0709
030	15°	3400 0700
033	15°	3400 0712
035	15°	3400 0677
037	15°	3400 0715
040	15°	3400 0690
043	15°	3400 0717
045	15°	3400 0698
050	15°	3400 0704
060	15°	3400 0631
065	15°	3400 0385
070	15°	3400 0634
075	15°	3400 0412
085	15°	3400 0405
090	15°	3400 0636

DIAMETER DIAMETRO	JET ANGLE ANGOLO GETTO	CODE CODICE
025	25°	3400 0629
030	25°	3400 0606
035	25°	3400 0701
040	25°	3400 0702
045	25°	3400 0703
050	25°	3400 0705
053	25°	3400 0746
055	25°	3400 0707
060	25°	3400 0708
065	25°	3400 0710
070	25°	3400 0711
075	25°	3400 0713
080	25°	3400 0714
085	25°	3400 0716
090	25°	3400 0637
10	25°	3400 0488
11	25°	3400 0543
12	25°	3400 0639
13	25°	3400 0489
15	25°	3400 0658
20	25°	3400 0675

030	40°	3400 0401
035	40°	3400 0382
040	40°	3400 0399
045	40°	3400 0393
050	40°	3400 0390
055	40°	3400 0378
065	40°	3400 0394
075	40°	3400 0414
085	40°	3400 0407
090	40°	3400 0638

• Tabella portate ugelli a pagina 120. / Tabella portate ugelli a pagina 120.

NOZZLES
UGELLI



CERAMIC 350 BAR
UNPACKED NOZZLE
UGELLO CERAMICA 350 BAR
NON CONFEZIONATO



CERAMIC 500 BAR
UNPACKED NOZZLE
UGELLO CERAMICA 500 BAR
NON CONFEZIONATO



DIAMETER DIAMETRO	JET ANGLE ANGOLO GETTO	CODE CODICE
075	0°	3400 0623
080	0°	3400 0625
090	0°	3400 0645
11	0°	3400 0624
15	0°	3400 0626

080	15°	3400 0697
090	15°	3400 0696

035	25°	3400 0642
040	25°	3400 0628
050	25°	3400 0618
075	25°	3400 0617
080	25°	3400 0612
090	25°	3400 0644
10	25°	3400 0643
11	25°	3400 0613
15	25°	3400 0611

DIAMETER DIAMETRO	JET ANGLE ANGOLO GETTO	CODE CODICE
030	0°	3400 0619
035	0°	3400 0621
040	0°	3400 0620
050	0°	3400 0622

025	15°	3400 0627
030	15°	3400 0614
035	15°	3400 0615
040	15°	3400 0616
045	15°	3400 0659
050	15°	3400 0689
055	15°	3400 0695

• Tabella portate ugelli a pagina 120. / Tabella portate ugelli a pagina 120.

NOZZLES FLOW CHART
 TABELLA PORTATE UGELLI

	bar MPa Psi															 l/min US gpm
	50 5 725	70 7 1015	100 10 1450	120 12 1740	150 15 2176	180 18 2611	200 20 2901	220 22 3191	250 25 3626	280 28 4061	300 30 4351	350 35 5076	400 40 5802	450 45 6527	500 50 7252	
010	1,6 0,43	1,9 0,50	2,3 0,60	2,5 0,66	2,8 0,74	3,1 0,81	3,2 0,85	3,4 0,89	3,6 0,95	3,8 1,01	3,9 1,04	4,3 1,13	4,6 1,20	4,8 1,28	5,1 1,35	
015	2,4 0,64	2,9 0,76	3,4 0,90	3,7 0,99	4,2 1,11	4,6 1,21	4,8 1,28	5,1 1,34	5,4 1,43	5,7 1,51	5,9 1,56	6,4 1,69	6,8 1,81	7,3 1,92	7,6 2,02	
020	3,2 0,85	3,8 1,01	4,6 1,20	5,0 1,32	5,6 1,47	6,1 1,62	6,4 1,70	6,8 1,79	7,2 1,90	7,6 2,02	7,9 2,09	8,5 2,25	9,1 2,41	9,7 2,55	10,2 2,69	
022	3,5 0,94	4,2 1,11	5,0 1,32	5,5 1,45	6,1 1,62	6,7 1,78	7,1 1,87	7,4 1,96	7,9 2,09	8,4 2,22	8,7 2,29	9,4 2,48	10,0 2,65	10,6 2,81	11,2 2,96	
025	4,0 1,06	4,8 1,26	5,7 1,51	6,2 1,65	7,0 1,84	7,6 2,02	8,1 2,13	8,5 2,23	9,0 2,38	9,5 2,52	9,9 2,61	10,7 2,82	11,4 3,01	12,1 3,19	12,7 3,37	
028	4,5 1,19	5,3 1,41	6,4 1,69	7,0 1,85	7,8 2,06	8,6 2,26	9,0 2,38	9,5 2,50	10,1 2,67	10,7 2,82	11,1 2,92	11,9 3,15	12,8 3,37	13,5 3,58	14,3 3,77	
030	4,8 1,28	5,7 1,51	6,8 1,81	7,5 1,98	8,4 2,21	9,2 2,42	9,7 2,55	10,1 2,68	10,8 2,86	11,4 3,02	11,8 3,13	12,8 3,38	13,7 3,61	14,5 3,83	15,3 4,04	
033	5,3 1,41	6,3 1,66	7,5 1,99	8,2 2,18	9,2 2,43	10,1 2,67	10,6 2,81	11,2 2,95	11,9 3,14	12,6 3,33	13,0 3,44	14,1 3,72	15,0 3,97	16,0 4,22	16,8 4,44	
035	5,6 1,49	6,7 1,76	8,0 2,11	8,7 2,31	9,8 2,58	10,7 2,83	11,3 2,98	11,8 3,13	12,6 3,33	13,3 3,53	13,8 3,65	14,9 3,94	16,0 4,22	16,9 4,47	17,8 4,71	
037	6,0 1,58	7,1 1,86	8,4 2,23	9,2 2,44	10,3 2,73	11,3 2,99	11,9 3,15	12,5 3,30	13,3 3,52	14,1 3,73	14,6 3,86	15,8 4,17	16,9 4,46	17,9 4,73	18,9 4,98	
040	6,4 1,70	7,6 2,02	9,1 2,41	10,0 2,64	11,2 2,95	12,2 3,23	12,9 3,41	13,5 3,57	14,4 3,81	15,3 4,03	15,8 4,17	17,1 4,51	18,2 4,82	19,3 5,11	20,4 5,39	
042	6,8 1,79	8,0 2,12	9,6 2,53	10,5 2,77	11,7 3,10	12,8 3,39	13,5 3,58	14,2 3,75	15,1 4,00	16,0 4,23	16,6 4,38	17,9 4,73	19,1 5,06	20,3 5,36	21,4 5,66	
045	7,3 1,92	8,6 2,27	10,3 2,71	11,2 2,97	12,6 3,32	13,8 3,64	14,5 3,83	15,2 4,02	16,2 4,28	17,2 4,53	17,8 4,69	19,2 5,07	20,5 5,42	21,8 5,75	22,9 6,06	
050	8,1 2,13	9,5 2,52	11,4 3,01	12,5 3,30	14,0 3,69	15,3 4,04	16,1 4,26	16,9 4,47	18,0 4,76	19,1 5,04	19,7 5,21	21,3 5,63	22,8 6,02	24,2 6,39	25,5 6,73	
053	8,5 2,26	10,1 2,67	12,1 3,19	13,2 3,50	14,8 3,91	16,2 4,28	17,1 4,51	17,9 4,73	19,1 5,05	20,2 5,34	20,9 5,53	22,6 5,97	24,2 6,38	25,6 6,77	27,0 7,14	
055	8,9 2,34	10,5 2,77	12,5 3,31	13,7 3,63	15,4 4,06	16,8 4,44	17,7 4,68	18,6 4,91	19,8 5,24	21,0 5,54	21,7 5,74	23,5 6,20	25,1 6,62	26,6 7,03	28,0 7,41	
006	9,7 2,55	11,4 3,02	13,7 3,61	15,0 3,96	16,8 4,42	18,3 4,85	19,3 5,11	20,3 5,36	21,6 5,71	22,9 6,05	23,7 6,26	25,6 6,76	27,4 7,23	29,0 7,66	30,6 8,08	
065	10,5 2,77	12,4 3,27	14,8 3,91	16,2 4,29	18,1 4,79	19,9 5,25	21,0 5,54	22,0 5,81	23,4 6,19	24,8 6,55	25,7 6,78	27,7 7,32	29,6 7,83	31,4 8,30	33,1 8,75	
070	11,3 2,98	13,3 3,53	16,0 4,22	17,5 4,62	19,5 5,16	21,4 5,66	22,6 5,96	23,7 6,25	25,2 6,66	26,7 7,05	27,6 7,30	29,9 7,89	31,9 8,43	33,8 8,94	35,7 9,43	
075	12,1 3,19	14,3 3,78	17,1 4,52	18,7 4,95	20,9 5,53	22,9 6,06	24,2 6,39	25,4 6,70	27,0 7,14	28,6 7,56	29,6 7,82	32,0 8,45	34,2 9,03	36,3 9,58	38,2 10,10	
080	12,9 3,41	15,3 4,03	18,2 4,82	20,0 5,28	22,3 5,90	24,5 6,46	25,8 6,81	27,0 7,15	28,8 7,62	30,5 8,06	31,6 8,34	34,1 9,01	36,5 9,63	38,7 10,22	40,8 10,77	
085	13,7 3,62	16,2 4,28	19,4 5,12	21,2 5,61	23,7 6,27	26,0 6,87	27,4 7,24	28,7 7,59	30,6 8,09	32,4 8,56	33,6 8,87	36,2 9,58	38,8 10,24	41,1 10,86	43,3 11,44	
090	14,5 3,83	17,2 4,53	20,5 5,42	22,5 5,94	25,1 6,64	27,5 7,27	29,0 7,66	30,4 8,04	32,4 8,57	34,3 9,07	35,5 9,39	38,4 10,14	41,0 10,84	43,5 11,50	45,9 12,12	
10	16,1 4,26	19,1 5,04	22,8 6,02	25,0 6,60	27,9 7,37	30,6 8,08	32,2 8,52	33,8 8,93	36,0 9,52	38,1 10,08	39,5 10,43	42,6 11,27	45,6 12,04	48,4 12,77	51,0 13,46	
12	19,3 5,11	22,9 6,05	27,4 7,23	30,0 7,92	33,5 8,85	36,7 9,69	38,7 10,22	40,6 10,72	43,2 11,43	45,8 12,09	47,4 12,52	51,2 13,52	54,7 14,45	58,0 15,33	61,2 16,16	
15	24,2 6,39	28,6 7,56	34,2 9,03	37,5 9,89	41,9 11,06	45,9 12,12	48,4 12,77	50,7 13,40	54,1 14,28	57,2 15,11	59,2 15,64	64,0 16,90	68,4 18,06	72,5 19,16	76,5 20,20	
20	32,2 8,52	38,1 10,08	45,6 12,04	49,9 13,19	55,8 14,75	61,2 16,16	64,5 17,03	67,6 17,86	72,1 19,04	76,3 20,15	79,0 20,86	85,3 22,53	91,2 24,09	96,7 25,55	101,9 26,93	

NOZZLE SIZE / MISURA UGELLO

PRESSURE DROPS IN RUBBER HOSES
PERDITE DI CARICO NEI TUBI ALTA PRESSIONE

Pressure drops expressed in bar per 1 meter length of linear hose without fittings.

Specific gravity: 0,85 - Viscosity: 20 centistokes (cs) at 21 °C (70 °F).

Perdite di pressione in bar per una lunghezza del tubo flessibile di 1 m. lineare senza raccordi.

Peso specifico del fluido: 0,85 - Viscosità cinematica: 20 centistokes (cs) a 21 °C.

		inch mm											
		3/16" 4,8	1/4" 6,4	5/16" 7,9	3/8" 9,5	1/2" 12,7	5/8" 15,9	3/4" 19	1" 25,4	1"1/4 31,8	1"1/2 38,1	2" 50,8	3" 76,2
 l/min	1	0,242	0,075										
	2	0,466	0,146	0,066									
	4	0,996	0,293	0,133	0,058								
	8	2,433	0,613	0,250	0,117								
	10	3,540	0,880	0,335	0,144	0,045							
	15		1,776	0,660	0,273	0,068	0,027						
	20		3,080	1,129	0,462	0,116	0,041	0,018					
	30			2,159	0,887	0,228	0,082	0,032					
	40					0,379	0,144	0,050	0,014				
	50					0,555	0,192	0,075	0,021				
	60					0,756	0,263	0,111	0,029	0,009			
	70					0,970	0,373	0,154	0,037	0,013			
	80					1,250	0,475	0,200	0,049	0,016	0,007		
	90					1,531	0,560	0,237	0,066	0,021	0,008		
	100						0,653	0,274	0,073	0,025	0,010	0,003	
	125						0,964	0,393	0,103	0,036	0,014	0,004	
	150							0,567	0,147	0,050	0,019	0,005	
	175							0,735	0,186	0,060	0,026	0,007	
	200							0,920	0,228	0,083	0,033	0,009	
	250								0,347	0,124	0,050	0,013	
300								0,475	0,162	0,068	0,017	0,002	
400								0,832	0,303	0,118	0,032	0,004	
500								1,159	0,425	0,164	0,043	0,006	
600									0,562	0,222	0,057	0,008	
700									0,733	0,301	0,078	0,011	
800									0,924	0,383	0,098	0,014	
900									1,144	0,468	0,118	0,016	
1000										0,553	0,140	0,019	

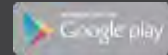

Follow us on



www.comet-spa.com



Comet Spa › via G. Dorso, 4 - 42124 Reggio Emilia › Italy
phone + 39 0522 386111 › www.comet-spa.com
vendite@comet.re.it › Fax + 39 0522 386300